

PEUGEOT



HANDBOOK

# 308



Download on the  
App Store

GET IT ON  
Google Play

## Access to the Handbook



### MOBILE APPLICATIONS

Install the **MYPEUGEOT APP** application (content available offline).

Also available in the **Scan MyPeugeot App** application.



### TOUCH SCREEN (depending on availability)



In the **Help** touch screen application, select the **User Manual** tab.

Several types of searches are available to access the information sought.

**For safety reasons, this application is not accessible while driving above 3 mph (5 km/h).**



### ONLINE

View or download the handbook at the following address:

<http://public.servicebox.peugeot.com/APddb/>



Scan this QR Code for direct access.

Select:

- the language,
- the vehicle and body style,
- the issue period of the handbook corresponding to the date of 1<sup>st</sup> registration of the vehicle.



This symbol indicates the latest information available.

# Welcome

---

Thank you for choosing a Peugeot 308 or a Peugeot e-308.

This document contains the key information and recommendations you will need to be able to explore your vehicle in complete safety. We strongly recommend familiarising yourself with it, as well as the Maintenance and Warranty Guide.

Your vehicle will be fitted with only some of the equipment described in this document, depending on its trim level, version and the specification for the country in which it was sold.

The descriptions and illustrations are for guidance only.

Automobiles PEUGEOT reserves the right to modify the technical specifications, equipment and accessories without having to update this document.

If ownership of your vehicle is transferred, please ensure this **Handbook** is passed on to the new owner.

 For any work on your vehicle, contact a member of the Manufacturer's dealer network, hereinafter referred to as a 'dealer', or a qualified workshop.

## Key



Safety warning



Additional information



Environmental protection feature



Left-hand drive vehicle



Right-hand drive vehicle



Location of equipment/button indicated using a black area



<b>Overview</b>	■	Front seats	<b>47</b>	<b>Safety</b>	<b>5</b>
		Steering wheel adjustment	<b>51</b>	General safety recommendations	<b>80</b>
		Heated steering wheel	<b>51</b>	Hazard warning lamps	<b>80</b>
<b>Eco-driving</b>	■	Mirrors	<b>51</b>	Horn	<b>81</b>
		Rear bench seat	<b>53</b>	Pedestrian horn (Hybrid, Rechargeable hybrid or Electric)	<b>81</b>
<b>Dashboard instruments</b>	<b>1</b>	Heating and Ventilation	<b>55</b>	Emergency or assistance	<b>81</b>
Driver information	<b>11</b>	Dual-zone automatic air conditioning	<b>56</b>	Event Data Recording system	<b>83</b>
Digital instrument panels	<b>11</b>	Front demisting/defrosting	<b>59</b>	Electronic stability control (ESC)	<b>84</b>
Warning and indicator lamps	<b>12</b>	Rear screen demisting/defrosting	<b>59</b>	Seat belts	<b>86</b>
Indicators	<b>19</b>	Heated windscreen	<b>59</b>	Airbags	<b>88</b>
Manual test	<b>25</b>	Temperature pre-conditioning (Rechargeable hybrid or Electric)	<b>59</b>	Child seats	<b>90</b>
Total distance recorder	<b>25</b>	Front fittings	<b>60</b>	Deactivating the front passenger airbag	<b>92</b>
Trip computer	<b>25</b>	Courtesy lamps	<b>64</b>	ISOFIX child seats	<b>93</b>
10-inch touch screen	<b>26</b>	Interior ambient lighting	<b>64</b>	i-Size child seats	<b>94</b>
i-Toggles	<b>29</b>	Rear fittings	<b>64</b>	Installing child seats	<b>95</b>
Remotely operable additional functions (Rechargeable hybrid or Electric)	<b>29</b>	Boot fittings	<b>65</b>	Child lock	<b>97</b>
<b>Access</b>	<b>2</b>	<b>Lighting and visibility</b>	<b>4</b>	<b>Driving</b>	<b>6</b>
Electronic key with remote control function and built-in key	<b>30</b>	Exterior lighting control stalk	<b>69</b>	Driving recommendations	<b>98</b>
Proximity Keyless Entry and Start	<b>32</b>	Direction indicators	<b>70</b>	Starting/switching off the engine	<b>100</b>
Central locking	<b>34</b>	Headlamp beam height adjustment	<b>70</b>	Starting rechargeable hybrid vehicles	<b>100</b>
Back-up procedures	<b>35</b>	Automatic illumination of headlamps	<b>71</b>	Starting/Switching off electric vehicles	<b>101</b>
Doors	<b>37</b>	Guide-me-home and welcome lighting	<b>71</b>	Electric parking brake	<b>102</b>
Boot	<b>37</b>	Automatic lighting systems - General recommendations	<b>72</b>	Manual gearbox	<b>105</b>
Motorised tailgate (SW)	<b>37</b>	Automatic headlamp dipping	<b>72</b>	Automatic gearbox (EAT8/e-EAT8)	<b>105</b>
Alarm	<b>41</b>	Automatic headlamp dipping	<b>72</b>	Electric dual-clutch automatic gearbox (e-DCS6/7)	<b>108</b>
Electric windows	<b>43</b>	Peugeot Matrix LED Technology 2.0	<b>73</b>	Drive selector (Electric)	<b>112</b>
Sunroof	<b>44</b>	Wiper control stalk	<b>75</b>	Driving modes	<b>113</b>
		Intermittent wipers	<b>77</b>	Hill start assist	<b>114</b>
		Automatic wipers	<b>77</b>	Gear shift indicator	<b>115</b>
		Changing a wiper blade	<b>78</b>	Stop & Start (Petrol or Diesel)	<b>115</b>
<b>Ease of use and comfort</b>	<b>3</b>			e-Auto mode (Hybrid)	<b>117</b>
Driving position	<b>46</b>			Tyre under-inflation detection	<b>118</b>

Driving and manoeuvring aids - General recommendations	119	Charging system (Electric)	173	Electric engines	226
Steering wheel with hands-on detection	121	Charging the traction battery (Electric)	177	Dimensions	227
Shortcuts for driving aids	121	Towing device	180	Identification markings	228
Road signs recognition	122	Towing device with quickly detachable towball	181		
Speed limiter	126	Roof bars	184	<b>PEUGEOT i-Connect Advanced - 10</b>	
Cruise control - Specific recommendations	128	Very cold climate screens	185	<b>PEUGEOT i-Connect</b>	
Cruise control	128	Snow chains	186	First steps	229
Drive Assist Plus	130	Energy economy mode	187	Customisation	232
Drive Assist 2.0	130	Bonnet	188	Steering mounted controls	233
Adaptive cruise control	131	Engine compartment	189	Applications	234
Lane positioning assist	135	Checking levels	189	Voice commands	234
Semi-automatic lane changing	138	Checks	191	Navigation	236
Active Safety Brake with Collision Risk Alert and Intelligent emergency braking assistance	142	AdBlue® (BlueHDi)	193	Connectivity	236
Distraction detection	146	Free-wheeling	195	Mirror Screen	238
Lane keeping assist	148	Advice on care and maintenance	196	Media	240
Long-distance blind spot monitoring	150			Phone	242
Parking sensors	151	<b>In the event of a breakdown 8</b>		Settings	243
Visiopark 1	153	Warning triangle	199	Help	243
Visiopark 3	155	Running out of fuel (Diesel)	199		
Rear cross traffic alert	157	Tool kit	199	<b>Vehicle data recording and privacy 11</b>	
		Temporary puncture repair kit	201		
<b>Practical information 7</b>		Spare wheel	204		
Compatibility of fuels	160	Changing a bulb	207	<b>Alphabetical index ■</b>	
Refuelling	160	Fuses	209		
Misfuel prevention (Diesel)	161	12 V battery/Accessory batteries	209		
Electrified vehicles - General recommendations	162	Towing the vehicle	217		
Hybrid system	163			<b>Appendix ■</b>	
Rechargeable hybrid or electric vehicles - Specific recommendations	164	<b>Technical data 9</b>			
Rechargeable hybrid system	167	Engine technical data and towed loads	220		
Charging the traction battery	170	Petrol engines	221		
(Rechargeable hybrid)		Diesel engines	222		
		Hybrid engines	223		
		Rechargeable hybrid engines	224		

## Presentation

These illustrations and descriptions are provided for information. The presence and location of some elements vary depending on the version or trim level.

### Instruments and controls

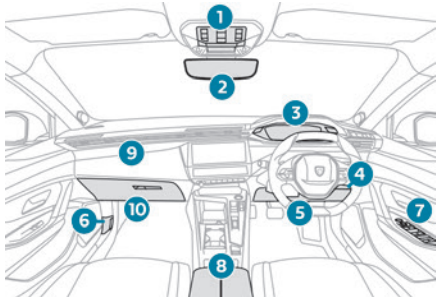
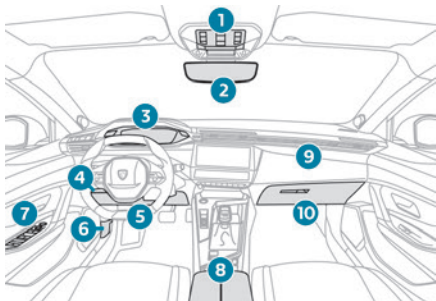

1. Emergency call/Assistance call  
Sunroof  
Alarm  
Courtesy lamp/Front reading lamps
2. Warning lamp display for seat belts and front passenger airbag  
Interior mirror
3. Instrument panel
4. Side control bar/Coin holder
5. Fusebox
6. Bonnet release
7. Door mirrors  
Electric windows  
Central locking
8. Front armrest  
USB sockets
9. Front passenger airbag
10. Glove box

### Centre console

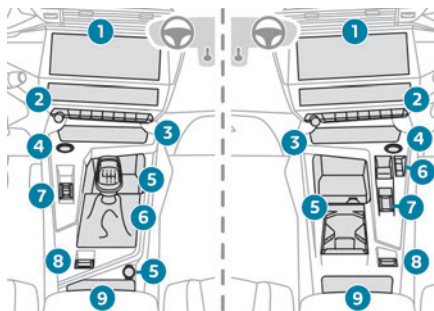

1. 10-inch touch screen
2. Centre control bars
3. Storage compartment or Wireless smartphone charger
4. Starting/Switching off the engine with START/STOP
5. Storage  
USB socket  
12 V socket  
Cup holder
6. Gearbox or Drive selector
7. Driving mode selector
8. Electric parking brake
9. Storage compartment/Smartphone storage

### Steering-mounted controls

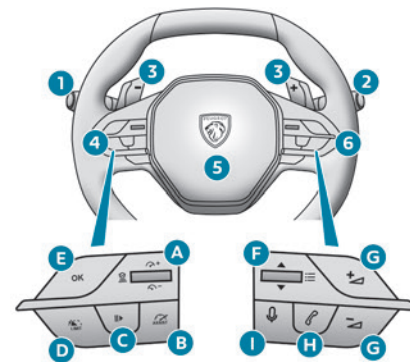

1. Exterior lighting controls/Direction indicators/  
Instrument panel display page/Service  
indicator
2. Wiper controls/Screenwash/Trip computer
3. Automatic gearbox control paddles
4. Speed limiter/Cruise control/Adaptive cruise  
control/Drive Assist Plus or Drive Assist 2.0  
controls
- A. Increase/Decrease the speed setting  
Display and adjustment of the distance  
setting to the vehicle in front (Adaptive cruise  
control)
- B. Select/Deselect the Cruise control  
Select/Deselect the Adaptive cruise control/  
Drive Assist Plus
- C. Start/Pause the Speed limiter or Cruise  
control with the speed setting saved  
Confirmation of vehicle restart after automatic  
stop (Adaptive cruise control with Stop&Go  
function)
- D. Select/Deselect the Speed limiter
- E. Activation of the Speed limiter or Cruise  
control with the speed setting saved  
Use the speed suggested by the Road signs  
recognition function
5. Horn/Driver front airbag
6. Audio system setting controls
- F. Press: Display favourite radio stations/media  
Up/Down: previous/next radio/media/  
smartphone selection  
Press: validation of a selection
- G. Increase/Decrease the volume

- H. Pick up/Hang up  
Access to the **Phone** application's call log
- I. Short press: system voice commands  
Long press: smartphone voice commands

### Side control bar



1. LED technology headlamps beam height  
adjustment
2. Motorised tailgate
3. Heated windscreen
4. Heated steering wheel
5. Opening the fuel filler flap
6. Temperature pre-conditioning operation  
indicator lamp

### Centre control bars

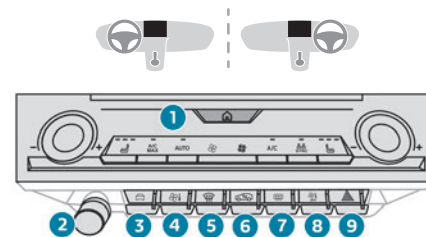

1. Automatic air conditioning system controls/  
HOME button  
or  
i-Toggles/HOME button
2. Audio system controls
3. Shortcuts for driving aids
4. Access to the **Climate** application
5. Windscreen and front windows demisting
6. Recirculation of interior air
7. Rear screen de-icing
8. Switching automatic air conditioning off
9. Hazard warning lamps

## Hybrid system

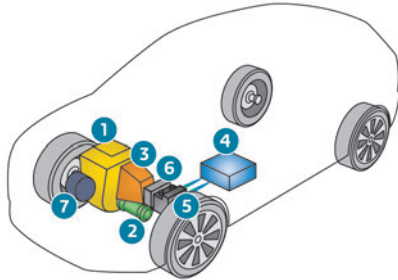

1. Petrol engine
2. Electric motor
3. 6-speed or 7-speed electric dual-clutch automatic gearbox (e-DCS6/7)
4. 48 V traction battery
5. 12 V accessory battery
6. DC/DC converter
7. Belt starter

### The 48 V hybrid technology requires no connection to charge the traction battery.

The **Hybrid system** does not operate continuously, but is activated according to the state of the vehicle, the state of charge of the traction battery, the thermal comfort of the passenger compartment (switching on the heating or air conditioning), the driving conditions (acceleration, deceleration, braking, engine start-up) and the road conditions (uphill, downhill):

- The vehicle always starts with the petrol engine to ensure the efficiency of the catalytic converter and the availability of the brake assist.
- In normal driving, the petrol engine and electric motor work together or separately to optimise fuel consumption and electrical energy or to charge the traction battery.
- During the acceleration phases, the electric motor provides an additional boost to reach the torque needed as fast as possible and to improve the acceleration at low speed.
- During the deceleration phases, the electric motor charges the traction battery, using the inertia of the vehicle.

– The driving in all-electric is possible for parking manoeuvring, for 20 mph (30 km/h) speed zones in city, on urban and country roads with smooth driving and on motorways in slight deceleration or downhill.

The electric motor is integrated into the automatic gearbox.

The DC/DC converter provides the link between the 12 V accessory power supply and the 48 V traction power supply.

The belt starter restarts the petrol engine after driving in all-electric.

## Rechargeable hybrid system

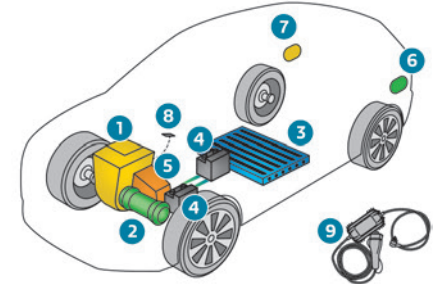

1. Petrol engine
2. Electric motor
3. Traction battery
4. 12 V accessories batteries
5. 7-speed or 8-speed electric automatic gearbox (e-DCS7 or e-EAT8)
6. Charging flap
7. Fuel filler flap
8. Driving mode selector
9. Domestic charging cable

The **rechargeable hybrid** technology combines two sources of energy: that of the petrol engine and that of the electric motor, which drive the front wheels (traction).

The engine and the motor can operate alternately or simultaneously, according to the driving mode selected and the driving conditions.



The electric power alone provides the mobility of the vehicle in **Electric** mode, and in **Hybrid** mode in case of moderate demand. It assists the petrol engine during starting and acceleration phases.

The electric power is supplied by a rechargeable traction battery.

## Electric drive system

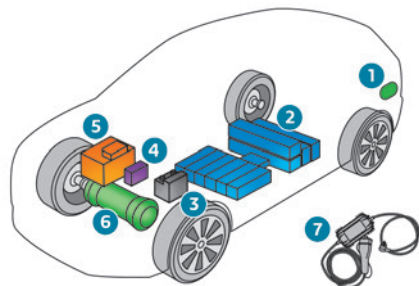

1. Charging connectors
2. Traction battery
3. Accessory battery
4. Heat pump
5. On-board charger
6. Electric motor
7. Charging cable

The charging connectors **1** enable 3 types of charging:

- Domestic charging in mode 2 using a domestic socket and associated charging cable **7**.

- Accelerated charging in mode 3 using an accelerated charging unit (Wallbox).

- Superfast charging in mode 4 using a fast public charger.

The 400 V traction battery **2** uses Lithium-Ion technology. It stores and supplies the energy required for the operation of the electric motor, air conditioning and heating. Its charge level is represented by an indicator and a reserve power warning lamp on the instrument panel.

The 12 V accessory battery **3** powers the vehicle's conventional electrical system. It is recharged automatically by the traction battery via the on-board charger.

The heat pump **4** provides passenger compartment heating and regulates traction battery and on-board charger cooling.

The on-board charger **5** manages the domestic charging (mode 2) and accelerated charging (mode 3) of the traction battery as well as the recharging of the 12 V accessory battery.

The electric motor **6** provides propulsion in accordance with the selected driving mode and driving conditions. It recovers energy during vehicle braking and deceleration phases.

## Labels

"Ease of use and comfort - Rear bench seat - Rear head restraints" section:



"Ease of use and comfort - Front fittings - Wireless smartphone charger" section:



"Lighting and visibility - Exterior lighting control stalk" and "In the event of a breakdown - Changing a bulb" sections:



"Safety - General safety recommendations - Installing electrical accessories" section:



"Safety - Child seats - Deactivating the front passenger airbag" section:



"Safety - ISOFIX mountings" section:



"Driving - Electric parking brake" section:



"Driving - Stop & Start" section:



"Practical information - Compatibility of fuels" section:



"Practical information - Rechargeable hybrid or electric vehicles - Specific recommendations" section:

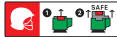

"Practical information - Rechargeable hybrid system" section:



"Practical information - Charging the traction battery (Rechargeable hybrid)" section:



"Practical information - Charging system (Electric)" section:



"Practical information - Charging the traction battery (Electric)" section:



"Practical information - Bonnet" section:



"Practical information - Checking levels - Engine coolant (Electric)" section:



"In the event of a breakdown - Temporary puncture repair kit" section:



"In the event of a breakdown - Spare wheel" section:



"In the event of a breakdown - 12 V battery/ Accessory batteries" section:



- For petrol, Diesel or hybrid versions



- For rechargeable hybrid versions



## Eco-driving

Eco-driving refers to a range of everyday practices that allow the motorist to optimise the vehicle's energy consumption (fuel and/or electricity) and CO<sub>2</sub> emissions.

### Optimise your use of the gearbox

With a manual gearbox, move off gently and change up promptly. While accelerating, change up early.

With an automatic gearbox, favour automatic mode. Do not depress the accelerator pedal heavily or suddenly.

The gear shift indicator prompts you to engage the most suitable gear. Whenever this indication is displayed on the instrument panel, follow it straight away.

With an automatic gearbox, this indicator appears only in manual mode.

### Drive smoothly

Maintain a safe distance between vehicles, use engine braking rather than the brake pedal and press the accelerator gradually. These practices help to save on energy consumption, reduce CO<sub>2</sub> emissions and decrease general traffic noise.

With a hybrid engine, engine braking is more efficient. Anticipate slowing down as much as you can and, if possible, favour deceleration with engine braking in order to charge the traction battery, to increase all-electric driving and to reduce fuel consumption.

With an EAT8 gearbox, with the gear selector in mode **D**, and except in Sport mode, favour "free-wheeling" by gradually lifting your foot fully off the accelerator pedal in order to save fuel. When the traffic is flowing smoothly, select the cruise control.

### Control the use of electrical equipment

Before moving off, if the passenger compartment is too warm, ventilate it by opening the windows and air vents before using the air conditioning. At speeds above 31 mph (50 km/h), close the windows and leave the air vents open. Consider using equipment that can help keep the temperature in the passenger compartment down.

Unless automatically regulated, switch off the air conditioning as soon as the desired temperature has been reached.

Switch off the demisting and defrosting functions, if they are not managed automatically.

Switch off the heated seat and heated steering wheel as soon as possible.

Adapt your use of the headlamps and/or foglamps to the level of visibility, in accordance with current legislation in the country in which you are driving.

Avoid running the engine before moving off, particularly in winter (other than in severe wintry conditions: temperature below -23°C). The vehicle will warm up much faster while driving.

As a passenger, avoid connecting your multimedia devices (e.g. film, music, video game) to help reduce the consumption of energy. Disconnect all portable devices before leaving the vehicle.

### Limit the causes of excess consumption

Spread loads throughout the vehicle. Place the heaviest items in the boot as close as possible to the rear seats.

Limit the loads carried in the vehicle and minimise wind resistance (e.g. roof bars, roof rack, bicycle carrier, trailer). Preferably, use a roof box.

Remove roof bars and roof racks after use.

At the end of winter, remove snow tyres and refit summer tyres.

### Comply with the servicing instructions

Check tyre pressures regularly, with the tyres cold, referring to the label in the door aperture on the driver's side.

Carry out this check in particular:

- before a long journey.
- at each change of season.
- after a long period out of use.

Do not forget the spare wheel and, where applicable, the tyres on your trailer or caravan.

Have your vehicle serviced regularly (e.g. engine oil, oil filter, air filter, passenger compartment filter, etc.). Observe the schedule of operations in the manufacturer's service schedule.

With a BlueHDi Diesel engine, if the SCR system has a fault, your vehicle will emit pollution. Visit

a PEUGEOT dealer or a qualified workshop as soon as possible to restore your vehicle's nitrogen oxide emissions to legal levels.

When filling the fuel tank, do not continue after the third cut-out of the nozzle, to avoid overflow. You will only see the fuel consumption of your new vehicle settle down to a consistent average after the first 1,900 miles (3,000 kilometres).

### Optimising the driving range of electrified vehicles

The vehicle's consumption of electrical energy greatly depends on the route profile, speed and driving style, as well as the use of the heating/air conditioning.

Favour the **ECO** and **CHARGE** zones of the power indicator by driving smoothly and at a steady speed.

#### Hybrid vehicles

Maximise the vehicle's inertia by releasing the accelerator pedal so that the vehicle slows down by itself (e.g. when driving downhill or approaching a traffic light).

When the accelerator pedal is released, provided that the slider on the power indicator in the instrument panel is still moving in the **CHARGE** zone, energy recovery is optimal.

Energy recovery makes it possible to make efficient use of the "passive" phases of driving (deceleration).

The recovered energy is used to recharge the traction battery and is then used for all-electric driving or further acceleration.

When the traction battery is almost full, the energy recovery is gradually reduced.

#### Rechargeable hybrid vehicles

Connect the vehicle as soon as possible.

Anticipate slowing down as much as possible and, if possible, favour decelerations with the regenerative braking function activated (power indicator in the **CHARGE** zone).

With the vehicle connected, carry out temperature pre-conditioning before setting off. To optimise consumption during a journey:

- ▶ Program a destination into the vehicle's GPS navigation system.
- ▶ Select the **Hybrid** driving mode.
- ▶ Make sure that the battery charge level is close to maximum.
- ▶ Do not use the e-Save function while driving.
- ▶ Use the heating/air conditioning system wisely.

#### Electric vehicles

Program a destination into the vehicle's GPS navigation system to optimise consumption during a journey.

Anticipate the need to slow down, and brake smoothly, whenever possible using engine braking with the regenerative braking function, which will move the power indicator into the "**CHARGE**" zone.

Use the air conditioning rather than the heating to demist the passenger compartment.

## Driver information

### Instrument panel

The instrument panel displays all the information the driver needs about the status of the vehicle's various systems.

This information appears in the form of warning and indicator lamps and messages.

The instrument panel is in the form of a fully digital screen.

### Digital instrument panels

Digital instrument panels are of the head-up or 3D head-up type.

They can be personalised using a system of pages and widgets.

Depending on the page displayed, certain information is not displayed or is presented differently.

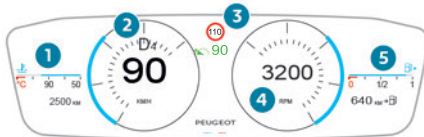

Petrol / Diesel

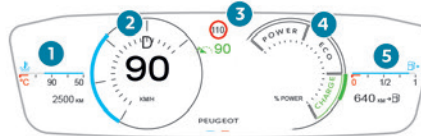

Hybrid

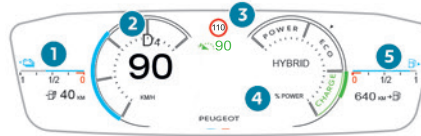

Rechargeable hybrid

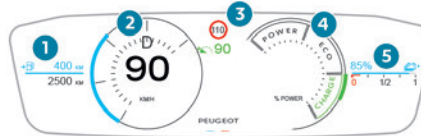

Electric

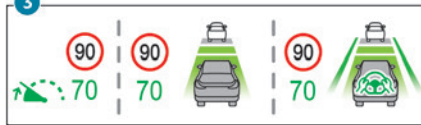

1. Coolant temperature indicator (°C) (Petrol, Diesel or Hybrid)  
Total distance recorder (miles or km) (Petrol, Diesel or Electric)  
Battery charge level and remaining range (miles or km) indicator (Rechargeable hybrid)  
Remaining range (miles or km) indicator (Electric)
2. Gear shift indicator (arrow and recommended gear) (Petrol, Diesel, Hybrid or Rechargeable hybrid)  
Selector position and gear on automatic gearbox (Petrol, Diesel, Hybrid or Rechargeable hybrid)  
Position on drive selector (Electric)  
Speedometer (mph or km/h)
3. Display of speed limit signs  
Driving aid in reduced display (if the function is activated)
4. Rev counter (rpm) (Petrol or Diesel)  
Driving mode selected (other than **Normal** mode)  
Power indicator (Hybrid, Rechargeable hybrid or Electric)  
**READY** indicator lamp (Rechargeable hybrid or Electric)
5. Fuel gauge and remaining range (miles or km) (Petrol, Diesel, Hybrid or Rechargeable hybrid)  
Battery charge level indicator (Electric)

The information listed in the personalisation page is as follows:

- Energy flows (Hybrid, Rechargeable hybrid or Electric).
- Current media.
- Driving aids (e.g. Extended Traffic Sign Recognition).
- Navigation (depending on equipment).
- Engine temperatures (Petrol, Diesel or Hybrid).
- Rev counter (Petrol or Diesel).

## Information displayed on the instrument panel

The information displayed on the instrument panel (e.g. warning lamps, indicators) may have a fixed or variable location depending on the page or the driving aid activated. For the functions that have indicator lamps for both operation and deactivation, there is only one dedicated location.

### Display language and units

These depend on the touch screen settings.

When travelling abroad, the speed must be shown in the official units of the country you are driving in (mph, miles or km/h, km).

### Choice of the displayed page

By default, pages are memorised in the instrument panel.

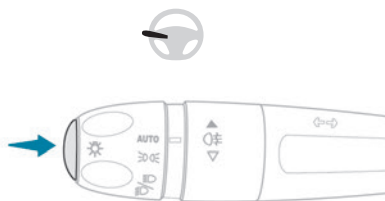

- ▶ Press the button located at the end of the lighting control stalk to scroll through the different pages.

The new page is applied immediately.

**i** When a message is displayed in a temporary window, pressing this button will cause this window to disappear immediately.

### Settings for displayed pages

The available settings operations are: addition, deletion and layout of pages and widgets.

It is possible to memorise up to 5 pages.

Each page may contain 1 or 2 widgets:

- With 1 widget, large display in central position.
- With 2 widgets, reduced display in side position.

The colour for each driving mode may be personalised. A default setting is suggested. The setting also matches the interior ambient lighting (depending on availability).



The settings are changed via the **Settings > Customization** touch screen application.

For more information on **Personalisation - Instrument Panel**, refer to the corresponding section for the Audio equipment and telematics systems.

## Warning and indicator lamps

Displayed as symbols, the warning and indicator lamps inform the driver of the occurrence of a malfunction (warning lamps) or of the operating status of a system (operation or deactivation indicator lamps). Certain lamps light up in two ways (fixed or flashing) and/or in several colours.

### Associated warnings

The illumination of a lamp may be accompanied by an audible signal and/or a message displayed in a screen.

Relating the type of alert to the operating status of the vehicle allows you to determine whether the situation is normal or whether a fault has occurred: refer to the description of each lamp for further information.

### When the ignition is switched on

Certain red or orange warning lamps come on for a few seconds when the ignition is switched on. These warning lamps should go off as soon as the engine is started.

For more information on a system or a function, refer to the corresponding section.

## Persistent warning lamp

If a red or orange warning lamp comes on, there may be a fault which needs further investigation.

### If a lamp remains lit

The references (1), (2) and (3) in the warning and indicator lamp description indicate whether you should contact a qualified professional in addition to the immediate recommended actions.

#### (1): You must stop the vehicle.

Stop as soon as it is safe to do so and switch off the ignition.

(2): Contact a PEUGEOT dealer or a qualified workshop.

(3): Go to a PEUGEOT dealer or a qualified workshop.

## List of warning and indicator lamps

### Red warning/indicator lamps

#### STOP



Fixed, associated with another warning lamp, accompanied by the display of a message and an audible signal.

A serious fault with the engine, braking system, power steering or automatic gearbox or a major electrical fault has been detected.

Carry out (1) and then (2).

### Traction battery overheating (Hybrid, Rechargeable hybrid or Electric)



Fixed, combined with the STOP warning lamp, accompanied by the display of a message and an audible signal.

The traction battery's temperature is too high.

Carry out (1).

**Evacuate the vehicle as quickly as possible and move to a safe distance.**

Carry out (2).

### Traction battery malfunction (Hybrid, Rechargeable hybrid or Electric)



Fixed, combined with the Service warning lamp, accompanied by the display of a message.

The traction battery has a fault.

Carry out (2).

### Maximum coolant temperature



Fixed. The temperature of the cooling system is too high.

Carry out (1), then wait until the engine has cooled down before topping up the level, if necessary. If the problem persists, carry out (2).

### Engine oil pressure (Petrol, Diesel, Hybrid or Rechargeable hybrid)



Fixed. There is a fault with the engine lubrication system.

Carry out (1) and then (2).

### System malfunction (Hybrid, Rechargeable hybrid or Electric)



Fixed.

A fault has been detected in the system (electric motor or traction battery).

Carry out (1) and then (2).

### Cable connected (Rechargeable hybrid or Electric)



Fixed when the ignition is switched on. The charging cable is connected to the vehicle's connector.



Fixed when the ignition is switched on, accompanied by a message.

It is not possible to start the vehicle while the charging cable is connected to the vehicle's connector.

Disconnect the charging cable and close the flap.

### 12 V battery charge



Fixed.

The battery charging circuit is faulty (e.g. dirty terminals, loose or severed alternator belt).

Carry out (1).

If the electric parking brake stops working, immobilise the vehicle:

- ▶ With the manual gearbox, engage a gear.
  - ▶ With the automatic gearbox or drive selector, fit the chock against one of the wheels.
- Clean and tighten the terminals. If the warning lamp does not go off when the engine is started, carry out (2).

## Braking



Fixed.

The brake fluid level in the braking circuit has dropped significantly.

Carry out (1), then top up with fluid that complies with the manufacturer's recommendations. If the problem persists, carry out (2).



Fixed.

The electronic brake force distribution (EBFD) system is faulty.

Carry out (1) and then (2).

## Electric parking brake



Fixed.

The electric parking brake is applied.



Flashing.

Application/release is faulty.

Carry out (1): park on flat ground (on a level surface).

With a manual gearbox, engage a gear.

With an automatic gearbox or drive selector, select mode **P**.

Switch off the ignition and carry out (2).

## Power steering



Fixed, accompanied by an audible signal.

The power steering has a fault.

Carry out (1) and then (2).

## Door(s) open



Fixed, associated with a message identifying the access.

An audible signal supplements the alert if the speed is higher than 6 mph (10 km/h).

A door or the boot is not properly closed.

## Seat belts not fastened/unfastened



Fixed or flashing, accompanied by an increasing audible signal.

A seat belt has not been fastened or has been unfastened.

## Orange warning/indicator lamps

### Service



Temporarily on, accompanied by the display of a message.

One or more minor faults, for which there is/are no specific warning lamp(s), have been detected. Identify the cause of the fault using the message displayed on the instrument panel.

You may be able to deal with some faults yourself, such as changing the battery in the remote control.

For other faults, such as with the tyre under-inflation detection system, carry out (3).



Fixed, accompanied by the display of a message.

One or more major faults, for which there is/are no specific warning lamp(s), have been detected. Identify the cause of the fault using the message displayed on the instrument panel, then carry out (3).



Fixed, accompanied by the message "**Parking brake fault**".

Automatic release of the electric parking brake is unavailable.

Carry out (2).



Service warning lamp fixed and service spanner flashing then fixed.

The servicing interval has been exceeded. The vehicle must be serviced as soon as possible.

Only with BlueHDi Diesel engines.

## Braking



Fixed.

A minor fault with the braking system has been detected.

Drive carefully.

Carry out (3).

## Malfunction (with electric parking brake)



Fixed, accompanied by the message "**Parking brake fault**".

The vehicle cannot be immobilised with the engine running.

If manual application and release commands are not working, the electric parking brake control is faulty.

The automatic functions must be used at all times and are automatically reactivated in the event of a fault with the control.

Carry out (2).



Fixed, accompanied by the message "**Parking brake fault**".

The electric parking brake is faulty: manual and automatic functions may not be working.

When stationary, to immobilise the vehicle:



▶ Pull the electric parking brake control and hold it for approximately 7 to 15 seconds, until the indicator lamp lights up on the instrument panel.

If this procedure does not work, secure the vehicle:

- ▶ Park on a level surface.
- ▶ With a manual gearbox, engage a gear.
- ▶ With an automatic gearbox or drive selector, select mode **P**, then place the supplied chock against one of the wheels.

Then carry out (2).

### Automatic functions deactivated (electric parking brake)



Fixed.

The "automatic application" (on switching off the engine) and "automatic release" (on acceleration) functions are deactivated.

If automatic application/release is no longer possible:

- ▶ Start the engine.
- ▶ Use the control to apply the electric parking brake.
- ▶ Take your foot fully off the brake pedal.
- ▶ Hold the control pressed in the release direction for between 10 and 15 seconds.
- ▶ Release the control.
- ▶ Depress and hold the brake pedal.
- ▶ Pull the control in the application direction for 2 seconds.
- ▶ Release the control and the brake pedal.

### Anti-lock braking system (ABS)



Fixed.

The anti-lock braking system has a fault. The vehicle retains conventional braking.

Drive carefully at moderate speed, then carry out (3).

### Power steering



Fixed.

A minor fault in the power steering has been detected.

Drive carefully at moderate speed, then carry out (3).

### Dynamic stability control (DSC)/Anti-slip regulation (ASR)



Fixed.

The system is deactivated.

The DSC/ASR system is reactivated automatically when the vehicle is restarted, and at speeds above approximately 31 mph (50 km/h).

At speeds below 31 mph (50 km/h), it can be reactivated manually.



Flashing.

DSC/ASR system regulation is activated in the event of a loss of grip or trajectory.



Fixed.

The DSC/ASR system has a fault. Carry out (3).

### Emergency brake malfunction (with electric parking brake)



Fixed, accompanied by the message "**Parking brake fault**".

Emergency braking does not deliver optimal performance.

If automatic release is not available, use manual release or carry out (3).

### Hill start assist



Fixed, accompanied by the message "**Anti roll-back system fault**".

The system has a fault.

Carry out (3).

### Post Collision Safety Brake



Fixed, associated with the Service warning lamp, accompanied by the display of a message and an audible signal.

The system has a fault.

Carry out (3) quickly.

### Engine self-diagnostic system (Petrol, Diesel, Hybrid or Rechargeable hybrid)



Flashing.

The engine management system has a fault.

There is a risk that the catalytic converter will be destroyed.

You **must** carry out (2).



Fixed.

The emissions control system has a fault.

The warning lamp should go off when the engine is started.

Carry out (3) without delay.

### AdBlue® (BlueHDi)

 On for around 30 seconds when starting the vehicle, accompanied by a message indicating the driving range.

The driving range is between 1,500 and 500 miles (2,400 and 800 km).

Top up the AdBlue®.

 Fixed, on switching on the ignition, accompanied by an audible signal and a message indicating the driving range.

The driving range is between 500 and 62 miles (800 and 100 km).

**Promptly** top up the AdBlue®, or carry out (3).

 Flashing, accompanied by an audible signal and a message indicating the driving range.

The driving range is less than 62 miles (100 km). You **must** top up the AdBlue® to **avoid engine starting being prevented**, or carry out (3).



 Flashing, accompanied by an audible signal and a message indicating that starting is prevented.

The AdBlue® tank is empty: the legally required engine immobiliser system prevents the engine from starting.

To restart the engine, top up the AdBlue® or carry out (2).



It is **essential** to add at least 10 litres of AdBlue® to the tank.

### SCR emissions control system (BlueHDi)

  Fixed when the ignition is switched on, accompanied by an audible signal and a message.

A malfunction of the SCR emissions control system has been detected.



This alert disappears once the exhaust emissions return to normal levels.

  Flashing AdBlue® warning lamp on switching on the ignition, with the

Engine self-diagnostics warning lamp on fixed, accompanied by an audible signal and a message indicating the driving range.

Depending on the message displayed, it is possible to drive for up to 685 miles (1,100 km) before the engine immobiliser is triggered.

Carry out (3) without delay, to **avoid starting being prevented**.

  Flashing AdBlue® warning lamp on switching on the ignition, with the Engine self-diagnostics warning lamp on fixed, accompanied by an audible signal and a message indicating that starting is prevented.

The engine immobiliser prevents the engine from restarting (the permitted driving limit has been exceeded after confirmation of a malfunction of the emissions control system).

To start the engine, carry out (2).

### Engine pre-heating (Diesel)

 Temporarily on (up to approximately 30 seconds in severe weather conditions).

When switching on the ignition, if the weather conditions and the engine temperature make it necessary.

Wait until the warning lamp goes off before starting.

When the warning lamp goes off, starting will occur immediately if you press and hold:

- the clutch pedal with a manual gearbox.
- the brake pedal with an automatic gearbox.



If the engine does not start, make the engine starting request again, while keeping your foot on the pedal.

### Under-inflation

 Fixed. The pressure in one or more tyres is too low.

Check the pressure of the tyres as soon as possible.

Reinitialise the detection system after adjusting the pressure.

  Under-inflation warning lamp flashing then fixed and Service warning lamp fixed.

The tyre pressure monitoring system is faulty. Under-inflation detection is no longer monitored. Check the tyre pressures as soon as possible and carry out (3).

## Parking sensors



Flashing.

The system detects an obstacle.



Fixed, accompanied by the display of a message and an audible signal.

The system has a fault.

Carry out (3).



Fixed, accompanied by the display of the message "**Parking Assistance Sensor blind: Clean sensor, see User Manual**".

The sensor is masked.

Stop as soon as it is safe to do so and switch off the ignition.

Clean the front and/or rear sensors.

## Airbags



Fixed, associated with the Service warning lamp and accompanied by the display of a message.

One of the airbags or seat belt pyrotechnic pretensioners is faulty.

Carry out (3).

## Front passenger airbag (ON)



Fixed.

The front passenger airbag is activated.

The control is set to the "**ON**" position.

**In this case, do not install a "rearward facing" child seat on the front passenger seat - risk of serious injury!**

## Front passenger airbag (OFF)



Fixed.

The front passenger airbag is deactivated.

The control is set to the "**OFF**" position.

A "rearward facing" child seat can be installed, unless there is a fault with the airbags (Airbags warning lamp on).

## Low fuel level (Petrol, Diesel, Hybrid or Rechargeable hybrid)



Fixed, accompanied by an audible signal and a message.

When it first comes on, there remains

**approximately 6 litres of fuel** in the tank (reserve).

Until the fuel level is topped up, this alert will be repeated every time the ignition is switched on, with increasing frequency as the fuel level decreases and approaches zero.

Refuel without delay to avoid running out of fuel.

**Never drive until completely empty**, as this could damage the emissions control and injection systems.

## Low traction battery level (Electric)



Fixed, accompanied by an audible signal. The state of charge of the traction battery

is low.

View the remaining range.

Put the vehicle on charge as soon as possible.

## Tortoise mode with limited driving range (Electric)



Fixed.

The state of charge of the traction battery is critical.

The engine power gradually decreases.

You must put the vehicle on charge.

If the warning lamp remains lit, carry out (2).

## Collision Risk Alert/Active Safety Brake



Flashing.

The system activates and brakes the vehicle momentarily to reduce the speed of collision with the vehicle in front.

For more information, refer to the **Driving** section.



Fixed, accompanied by the display of a message.

The system has been deactivated via the touch screen.



Fixed, accompanied by a message and an audible signal.

The system has a fault.

Carry out (3).



Fixed, accompanied by the display of the message "**Driving Assistance Sensor blind: Clean sensor, see User Manual**".

The sensor is masked.

Stop as soon as it is safe to do so and switch off the ignition.

Clean the front camera.



Fixed.

The system has a fault.

If these warning lamps come on after the engine is switched off and then restarted, carry out (3).



Fixed.

The system is deactivated temporarily because the driver and/or front passenger (depending on version) has been detected as present but the corresponding seat belt has not been fastened.

### Road signs recognition



Fixed, accompanied by the display of a message and an audible signal.

The system has a fault.

Carry out (3).



Fixed, accompanied by the display of the message "**Driving Assistance Sensor blind: Clean sensor, see User Manual**".

The sensor is masked.

Stop as soon as it is safe to do so and switch off the ignition.

Clean the front camera.

### Lane keeping assist



Flashing.

You are about to cross a broken lane marking without operating the direction indicators.

The system is activated, then corrects the trajectory if it detects a risk of unintentionally crossing a line or hard shoulder (depending on version).

For more information, refer to the **Driving** section.



Fixed.

The system has been automatically deactivated or placed on standby.



Fixed, accompanied by the display of the message "**Driving Assistance Sensor blind: Clean sensor, see User Manual**".

The sensor is masked.

Stop as soon as it is safe to do so and switch off the ignition.

Clean the front camera.



Fixed, accompanied by the display of a message and an audible signal.

The system has a fault.

Carry out (3).

### Driver Attention Warning by Camera (Distraction detection)



Fixed.

The system is deactivated.



Fixed, accompanied by the display of a message and an audible signal.

The system has a fault.

Carry out (3).



Fixed, accompanied by the display of the message "**Driving Assistance Sensor blind: Clean sensor, see User Manual**".

The sensor is masked.

Stop as soon as it is safe to do so and switch off the ignition.

Clean the front camera.

### Stop & Start (Petrol or Diesel)



Fixed, accompanied by the display of a message.

The Stop & Start system has been deactivated manually.

The engine will not switch off at the next traffic stop.

Reactivate the system via the touch screen.



Fixed.

The Stop & Start system has been deactivated automatically.

The engine will not switch off at the next traffic stop, if the exterior temperature is:

- below 0°C.
- above +35°C.

For more information, refer to the **Driving** section.



Flashing then fixed, accompanied by a message.

The system has a fault.

Carry out (3).

### e-Auto mode (Hybrid)



Fixed, accompanied by the display of a message.

The e-Auto mode has been deactivated manually.

The petrol engine will not switch off at the next release of the accelerator pedal or at the next traffic stop.

Reactivate the mode via the touch screen.

### Rear foglamps



Fixed.

The lamps are on.

### Peugeot Matrix LED Technology 2.0



Fixed, accompanied by an audible signal and a message.

A malfunction of the Peugeot Matrix LED Technology 2.0 headlamps or of the camera has been detected.

Carry out (2).

**Automatic headlamp dipping**

 Fixed, accompanied by an audible signal and a message.

A function or camera malfunction is detected. Carry out (2).

**Green warning/indicator lamps****Stop & Start (Petrol or Diesel)**

 Fixed.

When the vehicle stops, the Stop & Start system puts the engine into STOP mode.

 Flashing temporarily.

STOP mode is momentarily unavailable or START mode is automatically triggered.

For more information, refer to the **Driving** section.

**Vehicle ready to drive (Rechargeable hybrid or Electric)**

 Fixed, accompanied by an audible signal when it comes on.

The vehicle is ready to drive.

For electric vehicles, the thermal comfort systems are also available.

The indicator lamp goes out upon reaching a speed of approximately 3 mph (5 km/h) and lights up again when the vehicle stops moving.

The lamp will go out when you switch off the engine and exit the vehicle.

**Seat unoccupied/Seat belt not fastened**

 Fixed. (grey)

With the ignition on, one of the front or rear passenger seats is considered to be unoccupied.

**Seat occupied/Seat belt fastened**

 Fixed.

With the ignition on, the driver or a passenger has fastened their seat belt.

**Direction indicators**

 Flashing with audible signal. The direction indicators are on.

**Daytime running lamps/Sidelamps**

 Fixed.

With adequate ambient light, the daytime running lamps are on.

With inadequate ambient light, the sidelamps are on.

**Dipped beam headlamps**

 Fixed. The lamps are on.

**Peugeot Matrix LED Technology 2.0**

 Fixed. (grey)

The function is activated, but not available.



All the operating conditions have not been met.

 Fixed. The function is active.

All of the conditions are met: the system is operating.

For more information, refer to the **Lighting and visibility** section.

**Automatic headlamp dipping**

 Fixed.  The function has been activated via the touch screen.

The lighting control stalk ring is in the “AUTO” position.

For more information, refer to the **Lighting and visibility** section.

**Blue warning/indicator lamps****Main beam headlamps**

 Fixed. The lamps are on.

**Black/white warning lamps****Foot on the brake**

 Fixed. Insufficient or no pressure on the brake pedal.

With the engine running, before releasing the parking brake, to move out of mode **P** on an automatic gearbox or a drive selector.

**e-SAVE function (Rechargeable hybrid)**

 Fixed, accompanied by the reserved electric range.

The function is activated.

## Indicators

### Service indicator

The servicing information is expressed in terms of distance (miles or kilometres) and time (months or days).

The alert is given at whichever of these two terms is reached first.

The servicing information is displayed in the instrument panel. Depending on the version of the vehicle:

- The distance recorder display line indicates the distance remaining before the next service is due, or the distance travelled since it was due preceded by the "-" sign.
- An alert message indicates the distance remaining, as well as the period before the next service is due or how long it is overdue.

**i** The value indicated is calculated according to the distance covered and the time elapsed since the last service. The alert may also be triggered close to a due date.

### Service spanner



On temporarily when the ignition is switched on.

Between 620 and 1,860 miles (1,000 and 3,000 km) remain before the next service is due.



Fixed, when the ignition is switched on. The next service is due in less than 620 miles (1,000 km).

Have your vehicle serviced very soon.

### Service spanner flashing



Flashing then fixed, when the ignition is switched on.

(With BlueHDi Diesel engines, associated with the Service warning lamp.)

The servicing interval has been exceeded.

Have your vehicle serviced as soon as possible.

## Resetting the service indicator

The service indicator must be reset after each service.

If you have serviced your vehicle yourself:

- ▶ Switch the ignition off.

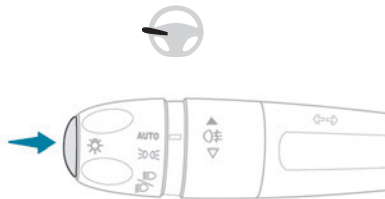

- ▶ Press and hold the button located on the end of the lighting control stalk.
- ▶ Switch on the ignition without starting the engine; a temporary display window appears and a countdown begins.
- ▶ When the display indicates =0, a confirmation message appears; release the lighting control stalk button and the spanner symbol disappears.

**i** If you disconnect the battery following this operation, lock the vehicle and wait at least 5 minutes for the reset to be registered.

## Reminder of the servicing information



Service information is accessible using the **Settings > Vehicle** application on the touch screen.

- ▶ Then select **Safety > Diagnostics**.

## Engine oil level indicator

(Depending on version)

On versions fitted with an electric gauge, the engine oil level status is displayed on the instrument panel for a few seconds when the ignition is switched on, after the servicing information, in the form of messages.

**i** The level read will only be correct if the vehicle is on level ground and the engine has been off for more than 30 minutes.

### Low oil level

This is indicated by the message "**Oil level incorrect**" on the instrument panel, accompanied by the lighting of the Service warning lamp and an audible signal.

If a low oil level is confirmed by a check using the dipstick, the level must be topped up to avoid damage to the engine.

For more information on **Checking levels**, refer to the corresponding section.

### Oil gauge malfunction

This is indicated by the message "**Oil level measurement invalid**" on the instrument panel. Consult a PEUGEOT dealer or a qualified workshop.

**!** In the event of a malfunction of the electric gauge, the oil level is no longer monitored.  
If the system is faulty, you must check the engine oil level using the manual dipstick located in the engine compartment.  
For more information on **Checking levels**, refer to the corresponding section.

**!** After switching off the ignition, carefully open the bonnet and check the coolant level.

**i** For more information on **Checking levels**, refer to the corresponding section.

## Coolant temperature indicator

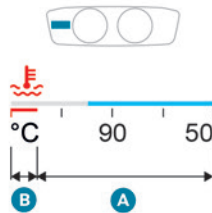

With the engine running:

- In zone **A**, the temperature is correct.
- In zone **B**, the temperature is too high. The associated warning lamp and the **STOP** warning lamp light up in red on the instrument panel, accompanied by the display of a message and an audible signal.

**You must stop the vehicle as soon as it is safe to do so.**

Wait a few minutes before switching off the engine.

## AdBlue® range indicators (BlueHDi)

The Diesel BlueHDi engines are equipped with a system that associates the SCR (Selective Catalytic Reduction) emissions control system and the Diesel particle filter (DPF) for the treatment of exhaust gases. They cannot function without AdBlue® fluid.

When the level of AdBlue® falls below the reserve level (between 1,500 and 0 miles (2,400 and 0 km)), a warning lamp lights up when the ignition is switched on and an estimate of the distance that can be travelled before engine starting is prevented is displayed in the instrument panel.

**!** The engine starting prevention system required by regulations is activated automatically once the AdBlue® tank is empty. It is then no longer possible to start the engine until the minimum level of AdBlue® has been topped up.

## Manual display of driving range

While the driving range is greater than 1,500 miles (2,400 km), it is not displayed automatically.







Driving range information is accessible using the **Settings > Vehicle** application on the touch screen.

▶ Then select **Safety > Diagnostics**.

## Actions required related to a lack of AdBlue®

The following warning lamps light up when the quantity of AdBlue® is below the reserve level: driving range of 1,500 miles (2,400 km). Together with the warning lamps, messages regularly remind you of the need to top up to avoid engine starting being prevented. Refer to the **Warning and indicator lamps** section for details of the messages displayed.

**i** For more information on **AdBlue® (BlueHDi)** and in particular on topping up, refer to the corresponding section.

Warning/indicator lamps on	Action	Remaining range
	Top up.	Between 1,500 miles and 500 miles (2,400 km and 800 km)
	Top up as soon as possible.	Between 500 miles and 62 miles (800 km and 100 km)
	<b>A top-up is vital</b> , there is a risk that the engine will be prevented from starting.	Between 62 miles and 0 miles (100 km and 0 km)
	To be able to restart the engine, add at least 10 litres of AdBlue® to the tank.	0 miles (km)

**i** **Taking into account of top-up**  
Top-up detection may not be instantaneous after addition. It may take a few

minutes of driving before the top-up detection is effective.

### Malfunction of the SCR emissions control system

#### Malfunction detection



If a malfunction is detected, these warning lamps come on, accompanied by an audible signal and the display of an "Emissions control fault" message.

The alert is triggered while driving when the fault is detected for the first time, and thereafter when switching on the ignition for subsequent journeys, for as long as the cause of the fault persists.

**i** If the fault is temporary, the alert disappears during the next journey, after self-diagnostic checks of the SCR emissions control system.

#### Malfunction confirmed during the permitted driving phase (between 685 miles and 0 miles (1,100 km and 0 km))

If the fault indication is still displayed permanently after 31 miles (50 km) of driving, the fault in the SCR system is confirmed. The AdBlue warning lamp flashes and a message is displayed ("Emissions

**control fault: starting prevented in X miles (kms)**"), indicating the driving range in miles or kilometres.

While driving, the message is displayed every 30 seconds. The alert is repeated when switching on the ignition.

You can continue driving for up to 685 miles (1,100 km) before the **engine starting prevention** system is triggered.

**!** Have it checked by a PEUGEOT dealer or a qualified workshop.

#### Starting prevented

Every time the ignition is switched on, the message "**Emissions control fault: Starting prevented**" is displayed.

**!** **To restart the engine**  
Contact a PEUGEOT dealer or a qualified workshop.

### Power indicator (Hybrid, Rechargeable hybrid or Electric)

The power indicator shows in real time the power demanded from the vehicle.

There are 3 zones:





### For hybrid versions

- POWER** **High power demand, using the combined capabilities of the petrol engine and the electric motor.**  
The slider is located in this zone during more dynamic driving phases when high levels of performance are being demanded.
- ECO** **Optimal use of energy (internal combustion or electric).**  
The slider is located in this zone when driving under electric power and when optimal use is being made of the petrol engine, both accessible by adopting a suitable driving style.
- CHARGE** **Energy recovery for recharging the traction battery.**  
The slider is located in this zone during deceleration: taking your foot off the accelerator pedal or braking.

**i** When the ignition is switched on and before the engine is started, the power indicator only displays "OFF".

### For rechargeable hybrid versions

- POWER** **High power demand, using the combined capabilities of the petrol engine and the electric motor.**  
The slider is located in this zone during more dynamic driving phases when high levels of performance are being demanded.
- ECO** **Optimal use of energy (internal combustion or electric).**  
The slider is located in this zone when driving under electric power and when optimal use is being made of the petrol engine, both accessible by adopting a suitable driving style. A symbol indicates the threshold at which the petrol engine will restart. The driver can therefore moderate their acceleration to remain in electric driving mode.
- CHARGE** **Energy recovery for partly recharging the traction battery.**  
The slider is located in this zone during deceleration: taking your foot off the accelerator pedal or braking.

### For electric versions



- CHARGE** Traction battery charging during deceleration and braking.
- ECO** Moderate energy consumption and optimised driving range.
- POWER** Energy consumption by the drive train during acceleration.
- NEUTRAL**  
When the ignition is switched on, the vehicle's electric drive train neither consumes nor generates energy; after sweeping over the indicator, the cursor returns to its "neutral" position: between **ECO** and **CHARGE**.

**i** With the ignition off, opening the driver's door activates the indicator, which moves to the "neutral" position: between **ECO** and **CHARGE**.

## Charge level indicator (Rechargeable hybrid or Electric)



### For rechargeable hybrid versions

The charge level of the traction battery and the remaining range in electric driving mode are permanently displayed when the vehicle is switched on.

**!** The range displayed depends on the use of the vehicle (type of driving and speed), the outside temperature and the activated comfort equipment.

### For electric versions

The traction battery's actual charge level and the remaining range are displayed continuously when the vehicle is started.

**i** With the ignition off, opening the driver's door activates the indicator.

## Associated warning lamps

Two successive alert levels indicate that the energy available has dropped to a low level:

### 1st level: Reserve



The state of charge of the traction battery is low.

- ▶ View the remaining range on the instrument panel.
- ▶ Put the vehicle on charge as soon as possible.

### 2nd level: Critical



The state of charge of the traction battery is critical.

- ▶ You must put the vehicle on charge.

**!** The remaining range is no longer calculated. The drive train power gradually decreases. The heating and air conditioning are switched off (even if the thermal comfort consumption indicator is not at the "ECO" level).

## Thermal comfort consumption indicator (Electric)



The gauge shows the consumption of the traction battery's electrical energy by the thermal comfort devices in the passenger compartment.

The devices in question are the heating and air conditioning systems.

This equipment can be used:

- If the vehicle is not plugged in, when the **READY** lamp is lit.
  - If the vehicle is plugged in, when the ignition is switched on ("Lounge" mode).
- Selecting **ECO** mode limits the performance of some of this equipment. The thermal comfort consumption indicator then moves into the "ECO" zone.

**i** To quickly heat or cool the passenger compartment, feel free to temporarily select the maximum heating or cooling setting.

When the heating is on maximum, the gauge on the thermal comfort consumption indicator is in the **MAX** zone. When the air conditioning is on maximum, it stays in the **ECO** zone. Excessive use of thermal comfort equipment, particularly at low speed, can significantly decrease the vehicle's range.

Remember to optimise equipment settings upon achieving the desired level of comfort, and adjust them if necessary whenever you start the vehicle.

After an extended period without using the heating, you may notice a slight odour during the first few minutes of use.

## Manual test

This function allows you to check certain indicators and display the alerts log.



The test is launched in the **Settings > Vehicle** touch screen application.

► Then select **Safety > Diagnostics**.

The following information is displayed on the instrument panel:

- Tyre pressures.
- Engine oil level (depending on engine).
- Next service due.
- Driving range associated with the AdBlue® and the SCR system (BlueHDi Diesel).
- Current alerts.



This information is also displayed automatically every time the ignition is switched on.

## Total distance recorder

The total distance recorder measures the total distance travelled by the vehicle since its initial registration.

With the ignition on, the total distance is displayed at all times. It remains displayed for 30 seconds after switching off the ignition. It is displayed when the driver's door is opened, and when the vehicle is locked or unlocked.



When travelling abroad, you may have to change the distance units (miles or km):

the displayed speed must be in the local country's official unit (mph or km/h). The unit is changed via the screen's configuration application, with the vehicle stationary.



### Rechargeable hybrid or electric vehicles

The total distance recorder is only accessible from the trip computer.

For more information on the **Trip computer**, refer to the corresponding section.

## Lighting dimmer

Used to manually adjust the brightness of the instruments and controls to suit the exterior light level.



It is configured in the **Settings > Brightness** touch screen application.

► In the **"Cockpit"** category, press or move the slider to the desired setting.

## Trip computer

Displays information related to the current trip (e.g. range, average consumption, average speed, distance travelled).

## Data displayed on the instrument panel

### Displaying the different tabs

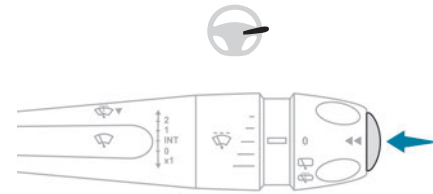

► Pressing the button located on the end of the wiper control stalk displays the following tabs in turn:

– Current information:

- Current consumption (Petrol, Diesel or Hybrid).
- Time counter for Stop & Start (Petrol or Diesel).
- Percentage of the current journey travelled in all-electric driving mode (Hybrid or Rechargeable hybrid).
- Total distance recorder (Rechargeable hybrid or Electric).

– Trips "1" then "2":

- Average speed.
- Average consumption.
- Distance travelled.

### End of trip page

(Depending on version)

When the ignition is switched off, the instrument panel automatically displays an additional page of the trip computer that recapitulates information about the last trip.

The end of trip page contains the following information:

- Range.
- Trip time.
- Distance travelled.
- Percentage of the current journey travelled in all-electric driving mode (Hybrid or Rechargeable hybrid).
- Average consumption.

## Trip reset



▶ When the desired trip is displayed, press the button on the end of the wiper control stalk for more than 2 seconds. Trips "1" and "2" are independent and are used in the same way.

## Definitions

### Range

(miles or km)

(Traction battery charge level percentage) (Electric)



Distance that can still be travelled with the fuel remaining in the tank (based on the average fuel consumption over the last few miles (kilometres) travelled).

Actual traction battery charge level and remaining range (Electric).

This value may vary following a change in driving style or terrain, leading to a significant change in current fuel consumption.

### For petrol or Diesel versions

When the range falls below 19 miles (30 km), dashes are displayed.

After filling with at least 5 litres of fuel, the range is recalculated and is displayed if it exceeds 62 miles (100 km).

Dashes appearing permanently in place of numbers while driving indicates a malfunction. Consult a PEUGEOT dealer or a qualified workshop.

### For electric versions

Two successive alert levels indicate that the energy available has dropped to a low level. For more information on the **Indicators**, and in particular the **Charge level indicator**, refer to the corresponding section.

### Current consumption

(mpg or l/100 km or km/l)

(miles/kWh or kWh/100 km or km/kWh) (Electric)



Calculated during the last few seconds.

This function is only displayed at speeds above 19 mph (30 km/h).

### Average consumption

(mpg or l/100 km or km/l)

(miles/kWh or kWh/100 km or km/kWh) (Electric)



Calculated since the last trip computer reset.

### Average speed

(mph or km/h)



Calculated since the last trip computer reset.

### Distance travelled

(miles or km)



Calculated since the last trip computer reset.

### Stop & Start time counter



(minutes/seconds or hours/minutes)

If your vehicle is fitted with the Stop & Start function, a time counter calculates the time spent in STOP mode during a journey.

The time counter is reset each time the ignition is switched on.

## 10-inch touch screen

This system gives access to the following elements:

- Time and exterior temperature.
- Heating/air conditioning system controls and reminders of settings.
- Settings for driving aid functions, comfort and safety functions, audio equipment and digital instrument panel.
- Settings of functions specific to rechargeable hybrid vehicles.
- Settings of functions specific to electric vehicles.
- Display of visual manoeuvring aid functions.
- Interactive handbook.

- Video tutorials (e.g. screen management, driving aids, voice recognition).
- Audio equipment and telephone controls with display of associated information.
- Connected services and display of associated information.
- Navigation system controls and display of associated information (depending on equipment).
- Voice recognition (depending on equipment).

**!** For safety reasons, always stop the vehicle before performing operations that require sustained attention. Some functions are not accessible while driving.

## Recommendations

These recommendations are valid for the touch screen and for the i-Toggles (depending on equipment).

The touch screen and the i-Toggles screen are capacitive touch screens.

Do not use pointed objects on the touch screen.

Do not touch the touch screen with wet hands.

► Use a soft, clean cloth to clean the touch screen.

## Main controls



Access to one of the home pages  
Return to the first home page



Direct access to the **Climate** application



Direct access to the **Shortcuts for driving aids**

► Swipe down from the upper edge of the touch screen to access a list of quick settings (e.g. **Brightness, Diagnostics**).

► Depending on the pages displayed on the screen, with or without the context menu, scroll the text by swiping with your finger, as with a smartphone.



Show/Hide context menu



Return to the previous page

► To change the status of a function, press the description for the corresponding line (change confirmed by the slider moving to the right/left: function activated/deactivated).



Access additional information on the function



Access to function parameters



Adding/Removing shortcuts



Short press, ignition off: system on/off.  
Short press, ignition on: mute/restore sound.

Long press, ignition on: start standby mode (mute sound, screens and clock display off).

Rotation: volume adjustment.

## Applications



Press this button to access the applications wall.



From any page, press the touch screen with three fingers to display the applications wall.

To obtain information about the other applications not listed here, refer to the sections describing the audio and telematic systems.



### ADAS

Activation/Deactivation and configuration of the driving aid functions.



### Climate

Settings for temperature, air flow, etc.

For more information on **Dual-zone automatic air conditioning**, refer to the corresponding section.

Activation/Deactivation of the heated steering wheel.

For more information on the **Heated steering wheel**, refer to the corresponding section.



### Seats

Activation/Deactivation and configuration of the seat comfort functions (heating and massages).

For more information on the **Heated seats** or on the **Multi-point massages**, refer to the corresponding section.



### Settings

Main settings for the audio system, touch screen and digital instrument panel.

Activation/Deactivation and configuration of the exterior lighting, vehicle access and safety functions.



### Energy

#### For rechargeable hybrid versions

Access to the rechargeable hybrid system features (energy flow, consumption statistics, deferred charging, e-SAVE function).

#### For electric versions

Access to the charging system features (energy flow, consumption statistics, deferred charging).

## Energy application (Rechargeable hybrid or Electric)

### Energy Flow

#### For rechargeable hybrid versions

The page shows the operation of the rechargeable hybrid system in real time.

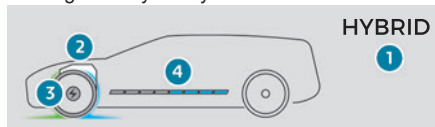

1. Active driving mode
2. Petrol engine
3. Electric motor
4. Estimated traction battery charge level

The energy flows have a specific colour for each type of driving:

- **Blue:** 100% electrical energy.
- **White:** energy from the petrol engine.
- **Green:** energy recovery.

#### For electric versions

The page shows the operation of the electric drive train in real time.

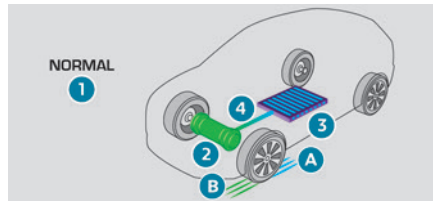

1. Active driving mode
2. Electric motor
3. Estimated traction battery charge level
4. Energy flows

The energy flows have a specific colour for each type of driving:

- A. Blue:** energy consumption
- B. Green:** energy recovery

### Statistics

#### For rechargeable hybrid versions

This page shows electrical energy and fuel consumption statistics.

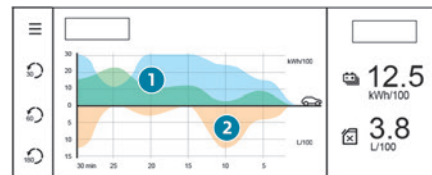

1. Average electrical consumption for the current trip (kWh/100 km) and historical values:

- Blue graph: energy consumed directly from the traction battery.
- Green graph: energy regenerated during deceleration and braking phases used to recharge the traction battery.

2. Average fuel consumption for the current trip (l/100 km) and historical values (orange graph).

#### For electric versions

This page shows electrical energy consumption statistics.

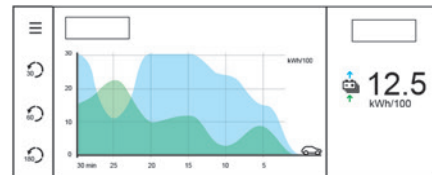

– Blue graph: energy consumed directly from the traction battery.

- Green graph: energy regenerated during deceleration and braking phases used to recharge the traction battery.

The average result for the current trip is stated in kWh/100 km.

It is possible to view data for the last 30, 60 or 180 minutes by clicking on the corresponding value on the left of the graph.

## Charging

This page allows you to programme deferred charging.

For more information on **Charging the traction battery**, refer to the corresponding section.

## e-SAVE (Rechargeable hybrid)

The **e-SAVE** function makes it possible to reserve all or part of the electrical energy of the traction battery to be used later during a journey (e.g. passing through an urban area or an area reserved for electric vehicles).

► Activate the function by pressing **Set e-SAVE**, then select the electric range to be reserved (**6 miles (10 km)**, **12 miles (20 km)** or the full range **Maximum**).



Activation of the function is confirmed by the lighting of this indicator lamp on the instrument panel and the indication of the energy reserve in miles or kms.

► To use the energy reserve, choose the **Electric** driving mode in the mode selector.

! If the requested range exceeds the available range (not recommended), the internal combustion engine starts to recharge the traction battery up to the requested threshold. This leads to excessive fuel consumption.

## i-Toggles

This system is an additional touch screen associated with the PEUGEOT i-Connect Advanced. It is designed to provide a personalised display of shortcuts to applications or presets.

By default, it directs you to the main applications: **Media, Climate, Navigation, Phone, Mirror Screen**, etc.

The shortcuts can be replaced by: radio preset, temperature preset, pre-selected destination, pre-selected contact, pre-selected smartphone, etc.

For more information on **Personalisation - i-Toggles**, refer to the corresponding section for the Audio equipment and telematics systems.

! If the vehicle is exposed to sunlight for an extended period, the touch screen can become very hot.  
Wait a few minutes before using the system.

## Remotely operable additional functions (Rechargeable hybrid or Electric)

(Depending on country of sale)



The following functions are available from the **MYPEUGEOT APP** application, which is accessible from a smartphone:

- Managing the traction battery charging (deferred charging).
- Managing the temperature pre-conditioning.
- Viewing the state of charge and range of the vehicle.

### Installation procedure

- Download the **MYPEUGEOT APP** application from the appropriate online store for your smartphone.
  - Create an account.
  - Enter the vehicle identification number (available on the vehicle registration certificate).
- For more information on **Identification markings**, refer to the corresponding section.

### i Network coverage

In order to be able to use the various remotely operable features, ensure that your vehicle is located in an area covered by the mobile network.

A lack of network coverage may prevent communication with the vehicle (for example, if it is in an underground car park). In such cases, the application will display a message indicating that the connection with the vehicle could not be established.

## Electronic key with remote control function and built-in key

### Remote control function

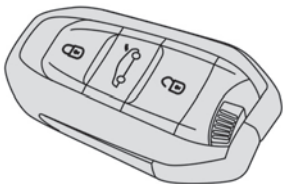

The remote control can be used to perform the following remote functions (depending on version):

- Unlocking/Locking/Deadlocking the vehicle.
- Unlocking/Locking the boot.
- Folding/Unfolding the door mirrors.
- Activating/Deactivating the alarm.
- Locating the vehicle.
- Closing the windows.
- Closing the sunroof.
- Activating the vehicle's electronic immobiliser.

Back-up procedures allow the vehicle to be locked/unlocked in the event of a failure of the remote control, the central locking, the battery, etc. For more information on the **Back-up procedures**, refer to the corresponding section.

### Built-in key

Using the remote control built-in key, you can perform the following operations (depending on version):

- Activation/Deactivation of the manual child lock.
- Activation/Deactivation of the front passenger airbag.
- Back-up Unlocking/Locking of the doors.

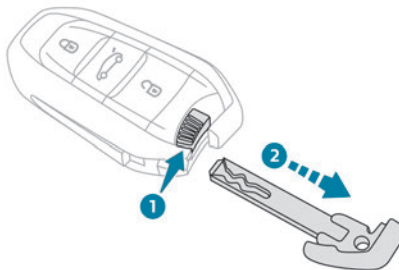

- ▶ To eject the key or put it back in place, pull and hold the button.

**!** Once the built-in key is ejected, always keep it with you to be able to carry out the corresponding back-up procedures.

### Unlocking the vehicle



Selective unlocking (driver's door, boot) is configured in the **Settings > Vehicle** touch screen application.

### Complete unlocking

- ▶ If the selective unlocking is deactivated, press the unlocking button.

### Selective unlocking

#### Driver's door

- ▶ Press the unlocking button.

The driver's door and the fuel filler flap are unlocked (Petrol, Diesel or Hybrid).

The driver's door is unlocked (Rechargeable hybrid).

The driver's door and the charging flap are unlocked (Electric).

- ▶ Press it **again** to unlock the other doors and the boot.

The charging nozzle can be unplugged on the second press.

Complete or selective unlocking, and alarm deactivation (depending on version), is confirmed by the flashing of the direction indicators and the lighting of the daytime running lamps. Depending on version, the door mirrors unfold.

### Selective unlocking and opening of the tailgate

By default, selective unlocking of the tailgate is deactivated and its motorised operation is activated.





► With a motorised tailgate: press and hold this button to unlock the boot and trigger the motorised opening of the tailgate.

► With a non-motorised tailgate: press and hold this button to unlock the boot and partially open the tailgate.

When selective unlocking of the tailgate is activated, the doors and the fuel filler flap remain locked.

If selective unlocking of the tailgate is deactivated, pressing the button unlocks the whole vehicle.

**i** If motorised operation of the tailgate is deactivated, pressing the button partially opens the tailgate.

To lock the vehicle, it is necessary to close the tailgate again.

## Locking the vehicle



Depending on version, the activation/deactivation of the lock audible signal is configured in the **Settings > Vehicle** touch screen application.

### Normal locking

► Press the locking button.

The locking, and the activation of the alarm depending on version, is confirmed by the lighting of the direction indicators.

Depending on version, the door mirrors fold.

**i** An access (door or boot) that is not properly closed prevents locking of the vehicle. However, if the vehicle is fitted with an alarm, it will be activated after 45 seconds. If the vehicle is unlocked but the doors or boot are not subsequently opened, the vehicle will automatically lock itself again after about 30 seconds. If the vehicle is fitted with an alarm, it will be reactivated automatically.

### Deadlocking



**!** Deadlocking renders the interior door controls inoperative. It also deactivates the central locking buttons.

The horn remains operational.

**Never leave anyone inside the vehicle when it is deadlocked.**

- Press the locking button.
- Press the locking button again within 3 seconds to deadlock the vehicle (confirmed by the temporary lighting of the direction indicators).

For the vehicles equipped with the Proximity Keyless Entry and Start system, a double audible signal indicates that the vehicle is not deadlocked.

### Closing the windows and sunroof

An audible signal sounds in the passenger compartment before the start of movement to warn any occupants.

- To completely close the windows and, depending on version, the sunroof, press the locking button for more than 2 seconds.
- Press again to stop closing.

**!** Ensure that no person or object could prevent the correct closing of the windows and sunroof.

If, on versions with alarm, you want to leave the windows and/or sunroof partially open, you must first deactivate the interior volumetric alarm protection.

For more information on the **Alarm**, refer to the corresponding section.

### Locating the vehicle

This function helps you to spot your vehicle from a distance, with the vehicle locked:

- The direction indicators flash for approximately 10 seconds.
- The door mirror spotlamps come on.
- The courtesy lamps come on.



- Make a long press on this button.

## Advice

### ! Remote control

The remote control is a sensitive, high-frequency device; avoid handling it in your pocket, due to the risk of unintentionally unlocking the vehicle.

Avoid pressing the remote control buttons while out of range of the vehicle, due to the risk of rendering the remote control inoperative. It would then be necessary to reset it.

### ! Anti-theft protection

Do not modify the electronic vehicle immobiliser, as this might result in malfunctions.

### ! Locking the vehicle

Driving with the doors locked could make it more difficult for the emergency services to enter the passenger compartment in an emergency.

As a safety precaution, take the electronic key with you when leaving the vehicle, even for a short time.

### i Purchasing a second-hand vehicle

Have the key codes memorised by a PEUGEOT dealer, to ensure that the keys in your possession are the only ones able to start the vehicle.

## Proximity Keyless Entry and Start

This is a Keyless Entry and Start system. It enables automatic vehicle locking/unlocking simply by detecting the electronic key.

As long as the driver has the electronic key on their person, the vehicle unlocks as they approach and locks when they walk away.

Key recognition zones:

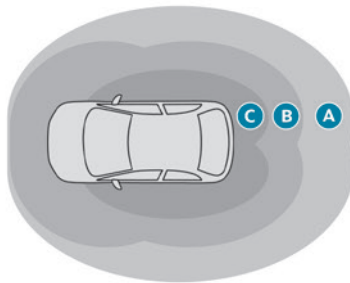

**Zone A:** welcome lighting on approaching the vehicle (between 2 and 5 metres from the vehicle).

**Zone B:** automatic locking on moving away from the vehicle (about 2 metres from the vehicle).

**Zone C:** automatic unlocking on approaching the vehicle (between 1 and 2 metres from the vehicle).



Automatic functions are configured in the **Settings > Vehicle** touch screen application.

## Unlocking the vehicle

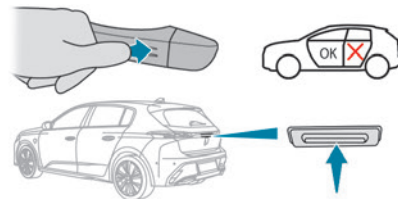

Selective unlocking (driver's door, boot) is configured in the **Settings > Vehicle** touch screen application.

### Complete unlocking

The vehicle (doors and boot) unlocks:

► Either automatically as the driver approaches in zone **C**, if the automatic functions are activated.

► Or by gently pressing the driver's door handle or the button on the boot.

Unlocking, and alarm deactivation (depending on version), is confirmed by the flashing of the direction indicators and lighting of the daytime running lamps.

Depending on version, the door mirrors unfold.

i If the electronic key remains around the vehicle (zones **A**, **B** or **C**) for more than 15 minutes without action, the automatic functions are deactivated. To unlock or lock

the vehicle, use the remote control or press the driver's door handle.

If using the door handle does not lock/unlock the vehicle, bring the electronic key closer and repeat the desired action.

## Selective unlocking

### Driver's door

It operates:

- ▶ Either automatically when approaching the driver's door, if the automatic functions are activated.
- ▶ Or by gently pressing the driver's door handle.

The driver's door and the fuel filler flap are unlocked (Petrol, Diesel or Hybrid).

The driver's door is unlocked (Rechargeable hybrid).

The driver's door and the charging flap are unlocked (Electric).

- ▶ Once inside the vehicle, to unlock all accesses, press the central unlocking button or pull the opening control on any door.

### Selective unlocking of the tailgate

The tailgate unlocks automatically as you approach the rear of the vehicle.

- ▶ Press the tailgate control to open the boot. The doors remain locked.

## Locking the vehicle



Depending on version, the activation/deactivation of the lock audible signal is configured in the **Settings > Vehicle** touch screen application.

### Normal locking

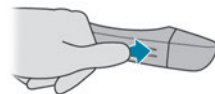

With the doors and boot closed, the vehicle locks:

- ▶ Either automatically, upon leaving zone **B**, if the automatic functions are activated.
- ▶ Or by gently pressing the driver's door handle.

Locking is confirmed by the lighting of the direction indicators, and by a double audible signal when the vehicle is locked upon walking away.

It is not possible to lock the vehicle if the electronic key is left inside the vehicle.

### Deadlocking



**!** Deadlocking renders the interior door controls inoperative. It also deactivates the central locking buttons. The horn remains operational.

### Never leave anyone inside the vehicle when it is deadlocked.

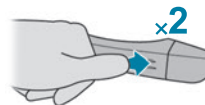

- ▶ Gently press the driver's door handle to lock the vehicle.
- ▶ Press it again within 3 seconds to deadlock the vehicle (confirmed by the temporary lighting of the direction indicators).

A double audible signal indicates that the vehicle is not deadlocked.

## Advice

**i** If one of the doors or the boot is still open or if the electronic key for the Keyless Entry and Start system has been left inside the vehicle, central locking will not take place.

**i** If the vehicle is unlocked but the doors or tailgate are not subsequently opened, the vehicle will automatically lock itself again after about 30 seconds. If fitted to the vehicle, the alarm is automatically reactivated (if previously activated).

**i** Automatic folding/unfolding of the door mirrors is configured in the touch screen. For more information on **Mirrors**, refer to the corresponding section.

**!** As a safety measure, never leave the vehicle, even for a short time, without taking the Keyless Entry and Start system's electronic key with you. Be aware of the risk of theft of the vehicle if the key is present in one of the defined areas while the vehicle is unlocked.

**!** In order to preserve the battery in the electronic key and the vehicle's battery:

- The unlocking on approach function (zone **C**) automatically switches to hibernation mode after several days (approximately one week) without being used. To unlock the vehicle, use the remote control or press on the driver's door handle. The next time the vehicle is started, the automatic unlocking and locking functions will be reactivated.
- If the welcome lighting is triggered several times in succession without the vehicle subsequently being started, it will be deactivated.
- All "hands-free" functions switch to hibernation mode after 21 days without being used. To restore these functions, unlock the vehicle using the remote control and start the engine.

**i** **Electrical interference**  
The electronic key may not work if it is close to an electronic device (e.g. mobile telephone (switched on or on standby), laptop computer, strong magnetic fields). If this occurs, move the electronic key away from the electronic device.

## Central locking

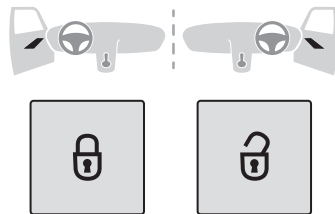

## Manual

► Press these buttons to lock/unlock the vehicle (doors and boot) from inside the passenger compartment. The indicator lamp comes on to confirm the central locking of the vehicle.

**!** Central locking does not take place if any of the doors are open.

**i** **When locking/deadlocking from the outside**

When the vehicle is locked or deadlocked from the outside, the indicator lamp in the locking button flashes and the buttons are inactive.

- After normal locking, pull one of the interior door controls to unlock the vehicle.
- After deadlocking, you must use the remote control, the "Keyless Entry and Start" system or the built-in key to unlock the vehicle.

## Automatic (anti-intrusion security)

The doors and boot lock automatically while driving (speed above 6 mph (10 km/h)).

To deactivate/reactivate this function (activated by default):

- Press the locking button until a confirmation message appears.

**i** **Transporting long or voluminous objects**

Press the central locking control to drive with the boot open and the doors locked. Otherwise, every time the speed of the vehicle exceeds 6 mph (10 km/h), the sound of the locks rebounding will be heard and an alert will be displayed.

## Back-up procedures

### Lost keys, remote control, electronic key

Go to a PEUGEOT dealer with the vehicle's registration certificate, your personal identification documents and if possible, the label bearing the key code.

The PEUGEOT dealer will be able to retrieve the key code and the transponder code, enabling a new key to be ordered.

### Complete unlocking/locking of the vehicle with the key

Use this procedure in the following situations:

- Remote control battery discharged.
- Remote control malfunction.
- Vehicle battery discharged.
- Vehicle in an area subject to strong electromagnetic interference.

In the first case, change the remote control battery.

In the second case, reinitialise the remote control.

Refer to the corresponding sections.

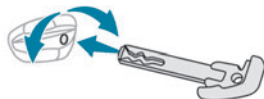

- ▶ Insert the key into the door lock.

- ▶ Turn the key towards the front or the rear to unlock or lock the vehicle.

**i** If the vehicle is fitted with an alarm, it will not be activated when locking with the key.

If the alarm is activated, the siren sounds when the door is opened; switch on the ignition to stop it.

### Central locking not functioning

Use these procedures in the following cases:

- Central locking malfunction.
- Battery disconnected or discharged.

**!** In the event of a malfunction of the central locking system, the battery must be disconnected to ensure that the vehicle is locked fully.

#### Front left-hand door

- ▶ Insert the key into the lock and turn it towards the front or rear of the vehicle to lock or unlock the door.

#### Other doors

##### Unlocking

- ▶ Pull the interior door opening control.

#### Locking

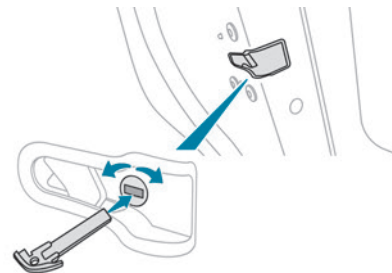

- ▶ Open the doors.
- ▶ For the rear doors, check that the child lock is not on.  
Refer to the corresponding section.
- ▶ Gently insert the key into the latch located in the door lock, then turn the latch an eighth of a turn towards the outside of the door.
- ▶ Close the doors and check from the outside that the vehicle is locked.

### Changing the battery

A message is displayed on the instrument panel when the battery needs changing.

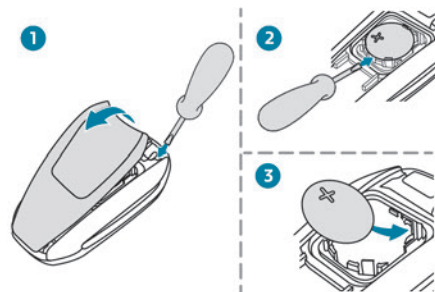
**Battery type: CR2032/3 volts.**

- ▶ Unclip the cover by inserting a small screwdriver in the slot and lift the cover.
- ▶ Remove the flat battery from its housing.
- ▶ Put the new battery in place, respecting the polarity. Start by inserting it into the contacts located in the corner, then clip the cover onto the unit.
- ▶ Reinitialise the remote control.

For more information on **Reinitialising the remote control**, refer to the corresponding section.



Do not throw remote control batteries away, as they contain metals that are harmful to the environment. Take them to an approved disposal point.

**!** This equipment contains a button type battery.

Do not swallow the battery. Risk of chemical burns!

Swallowing the battery can cause serious internal burning in only 2 hours and can be fatal.

If batteries have been swallowed or inserted into a part of the body, seek immediate medical advice.

Keep new and used batteries out of the reach of children.

If the battery compartment does not close properly, stop using the product and keep it out of the reach of children.

**!** Risk of explosion if the battery is replaced with an incorrect type!

Replace the battery with the same type.

**!** Risk of explosion or leaking of inflammable liquid or gas!

Do not use in/store in/place in an environment where the temperature is extremely high or where the pressure is extremely low due to very high altitude.

Do not try to burn, crush or cut a used battery.

## Reinitialising the remote control

Following replacement of the battery or in the event of a fault, it may be necessary to reinitialise the remote control.

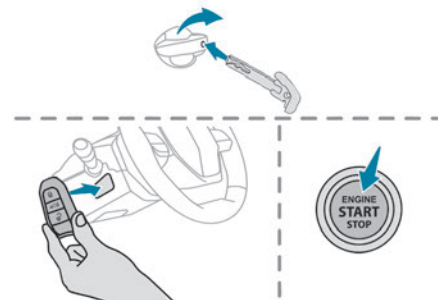

- ▶ Insert the mechanical key (incorporated into the remote control) into the lock to open the vehicle.
- ▶ Place the electronic key against the back-up reader on the steering column and hold it there until the ignition is switched on.
- ▶ **With a manual gearbox**, place the gear lever in neutral then fully depress the clutch pedal.
- ▶ **With an automatic gearbox or drive selector**, while in mode **P**, depress the brake pedal.
- ▶ Switch on the ignition by pressing the **START/STOP** button.

If the fault persists after reinitialisation, contact a PEUGEOT dealer or a qualified workshop without delay.

## Doors

### Opening

#### From outside

► After unlocking the vehicle or with the "Keyless Entry and Start" system electronic key in the recognition zone, pull the door handle.

#### From inside

► Pull the interior opening control of a door; this unlocks the vehicle completely.

- i With selective unlocking activated:
  - Opening the driver's door unlocks the driver's door only (if the vehicle has not already been completely unlocked).
  - Opening one of the passenger doors unlocks the rest of the vehicle.

## Boot

### Opening the tailgate

- With the vehicle unlocked or with the electronic key in the recognition zone, press the central tailgate control.
- Raise the tailgate.

i When selective unlocking is activated, the electronic key must be close to the rear of the vehicle.

! The tailgate is not designed to hold a bicycle carrier.

### Closing the tailgate

- Lower the tailgate using the interior grips.
- Release the grips and press down on the outside of the tailgate to close it.

! In the event of a malfunction or if you experience difficulty opening or closing the tailgate, have it checked by a PEUGEOT dealer or a qualified workshop without delay, to avoid the issue deteriorating and prevent any risk of the tailgate dropping, potentially causing serious injury.

### Back-up release

To manually unlock the boot in the event of a battery or central locking failure.

#### Unlocking

- Fold the rear seats to gain access to the lock from inside the boot.

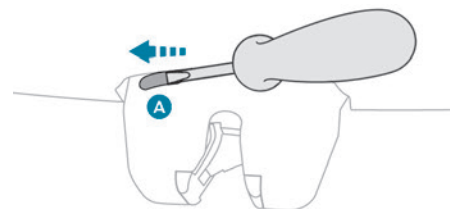

- Insert a small screwdriver into hole A of the lock to unlock the boot.
- Move the latch to the left.

#### Locking after closing

If the fault persists after closing again, the boot will remain locked.

### Motorised tailgate (SW)

(Depending on version)

The motorised tailgate must only be operated with the vehicle stationary.

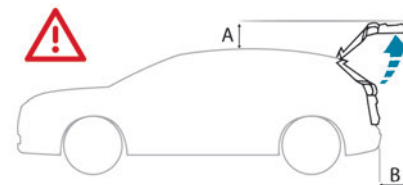

! Check that there is enough space to allow for the movement of the motorised tailgate.

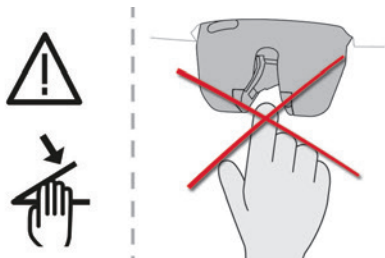

**!** Never insert a finger in the locking system of the motorised tailgate - risk of serious injury!

**!** To avoid the risk of injury through pinching or trapping, before and during operation of the motorised tailgate:

- ensure that there is no-one close to the rear of the vehicle.
- monitor the activity of the rear passengers, particularly any children.

### Bicycle carrier/Towing device

The motorised tailgate is not designed to support a bicycle carrier.

When installing a bicycle carrier on the towing device with connection of the cable to the trailer socket, the motorised operation of the tailgate will be automatically deactivated.

**!** If using a towing device or bicycle carrier not recommended by PEUGEOT, it is

essential to deactivate the motorised operation of the tailgate.

### Motorised operation



The motorised operation of the tailgate is configured in the **Settings > Vehicle** touch screen application.

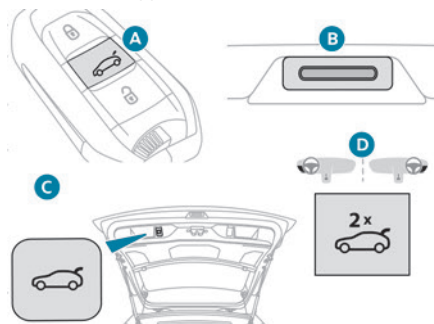

There are several ways of operating the tailgate:

- Using the Keyless Entry and Start system's electronic key
- Using the exterior tailgate control
- Using the interior tailgate control
- Using the control on the dashboard

**i** If motorised operation is not activated, the request to open with this function release the tailgate (partially-open position).

### Opening

- ▶ A long press on the central button **A** of the electronic key.
- or
- ▶ A short press on the exterior tailgate control **B** (with the electronic key on your person, if the vehicle or the tailgate is locked).
- or
- ▶ Two consecutive presses on the control **D** of the dashboard.

**i** The tailgate opens, either completely by default, or to the position memorised beforehand.

If motorised operation is not activated, these actions release the tailgate (partially-open position).

When the vehicle is locked, the request to open the boot with one of the controls **A** or **B** unlocks the vehicle, or only the boot if selective unlocking is activated, prior to the opening of the boot.

### Closing

- ▶ A long press on the central button **A** of the electronic key.
- or
- ▶ A short press on the exterior tailgate control **B**.
- or
- ▶ A short press on the interior tailgate control **C**.
- or



► Two consecutive presses on the control **D** of the dashboard.

**i** It is possible to interrupt the operation of the tailgate at any point.

Pressing one of these controls again interrupts the movement that is underway. Following the interruption of a movement, pressing one of these controls again reverses the movement.

If the tailgate is left open for an extended period of time, the tailgate may need to be closed manually to reset power tailgate functionality.

## Hands-free function (Hands-Free Tailgate Access)

With the electronic key on your person, this function allows the motorised tailgate to be opened, closed or stopped via a "kicking" movement under the rear bumper.



The "Handsfree Trunk Opening" function is configured in the **Settings > Vehicle** touch screen application.

**!** Ensure that you are steady on your feet before performing the "kicking" movement.

Take care not to touch the exhaust system which may be hot - risk of burns!

### **i** Rechargeable hybrid vehicles

The function is not available when the vehicle is connected.

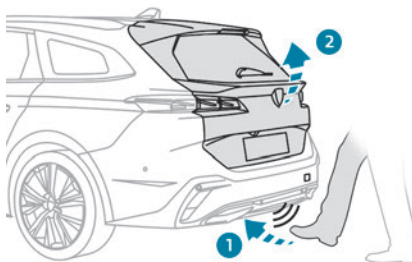
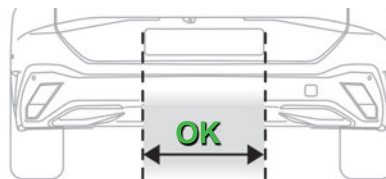

► Position yourself behind the vehicle by the number plate and perform a "kicking" movement in the "OK" detection zone.

The "kicking" movement must be given forwards, smoothly, not too fast and with a vertical movement from low to high. Raise the foot sufficiently and remove it immediately. Acknowledgement of the "kicking" movement is confirmed by the lighting of the direction indicators.

**!** "Sideward kicking" movements do not work. If the "kicking" movement has not been detected, wait at least 2 seconds before repeating the movement. Do not perform repetitive "kicking" movements.

If the motorised tailgate has not started to open or close, check that:

- the function is activated.
- the electronic key is on your person, outside the vehicle in the rear recognition area.
- the "kicking" movement was performed in the detection zone, close enough to the bumper.
- the foot was removed from the bumper quickly enough.

**i** When the vehicle is locked, the request to open the tailgate with this function unlocks the vehicle, or only the tailgate if selective unlocking is activated, prior to the opening of the tailgate. Closing the tailgate with the "Hands-Free Tailgate Access" function enables you to lock the vehicle.

## Recommendations on the hands-free function (Hands-Free Tailgate Access)

If it does not work, check that the electronic key is not exposed to a source of electromagnetic interference (e.g. smartphone).

The function may be deactivated or affected if there is rain or snow.

The function may not work correctly with a prosthetic leg.

In some circumstances, the tailgate may open or close by itself, particularly when:

- hitching up or removing a trailer.
- operating a towing device.
- fitting or removing a bicycle carrier.
- loading or unloading bicycles on/from a bicycle carrier.
- depositing or lifting something behind the vehicle.
- an animal approaches the rear bumper.
- washing the vehicle.
- maintenance is performed on the vehicle.
- accessing the spare wheel.

To avoid such operating problems, keep the electronic key away from the recognition zone or deactivate the hands-free function.

### Towing device

The installation of a towing device may disturb the detection system.

- ▶ Perform the "kicking" movement on the right side of the towing device.

## Memorising an opening position

To limit the opening angle of the motorised tailgate:

- ▶ move the tailgate to the desired position manually or by pressing the button.

- ▶ press button **C** or the exterior control **B** for more than 3 seconds (memorisation is confirmed by a brief audible signal).

A new memorisation operation cancels the previous one.

 Memorising is not available until the height of opening is more than or equal to 1 metre between the low position and the high position of the tailgate.

## Manual operation

The tailgate can be manoeuvred by hand, even with motorised operation activated.

The tailgate must be stationary.

- ▶ Move the tailgate as slowly and smoothly as possible.

When opening and closing the motorised tailgate manually, there is no assistance from gas struts. Resistance to opening and closing is therefore entirely normal.

### In case of the motor overheating

Repeatedly opening and closing the motorised tailgate can cause overheating of its electric motor, after which opening and closing will not be possible.

Allow at least 10 minutes for the electric motor to cool down before operating the tailgate again.

If you are unable to wait, operate it manually.

## Manual closing of the motorised tailgate in case of failure

This operation is **only necessary in the case of failure or deinitialisation/loss of the tailgate motor**.

If the failure originates from the battery, it is recommended to recharge it or change it with the tailgate **closed**.

In this situation, a significant force may be needed to close the tailgate.

- ▶ Close it gently without slamming, as slowly as possible, by pushing at the centre of the tailgate.

 Do not lower the tailgate by pushing at one of its sides - risk of damage!

## Precautions in use

### In wintry conditions

To avoid any operating problems, remove the snow or wait until the ice melts before requesting motorised opening of the tailgate.

### When washing

When washing the vehicle in an automatic car wash, do not forget to lock and move away from the vehicle to prevent any risk of unwanted opening.

## Alarm

(Depending on version)

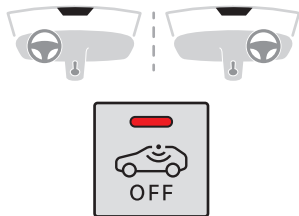

System which protects and provides a deterrent against theft and break-ins.

### Exterior perimeter monitoring

The system checks for opening of the vehicle. The alarm is triggered if anyone tries to open a door, the boot or the bonnet, for example.

### Interior volumetric monitoring

The system checks for any variation in volume in the passenger compartment.

The alarm is triggered if anyone breaks a window, enters the passenger compartment or moves inside the vehicle.

### Anti-tilt monitoring

The system checks for any change in the attitude of the vehicle.

The alarm goes off if the vehicle is lifted or moved.

**i** When the vehicle is parked, the alarm will not be triggered if the vehicle is knocked.

### **i** Rechargeable hybrid or electric vehicles

Depending on version, interior volumetric and anti-tilt monitoring may be reduced or even suspended during temperature pre-conditioning sequences.

### Self-protection function

The system checks whether any of its components are out of service.

The alarm is triggered if the battery, the central control or the siren wiring is put out of service or damaged.

### **!** Work on the alarm system

Consult a PEUGEOT dealer or a qualified workshop.

## Locking the vehicle with full alarm system

### Activation

- ▶ Switch off the ignition and exit the vehicle.
- ▶ Lock or deadlock the vehicle using the remote control or by pressing on the driver's door handle.

The monitoring system is also activated when the driver moves away from the vehicle.

When the monitoring system is active, the red indicator lamp in the button flashes once per second and the direction indicators come on for about 2 seconds.

The exterior perimeter monitoring is activated after 5 seconds and the interior volumetric monitoring after 45 seconds.

### **!** Door, boot or bonnet

If an opening is not properly closed, the vehicle is not locked, but the exterior perimeter monitoring will be activated after 45 seconds, at the same time as the interior volumetric monitoring.

### **!** Sunroof

If the sunroof remains open, the vehicle is locked with exterior perimeter monitoring activated but without interior volumetric or anti-tilt monitoring.

### Deactivation

- ▶ Press one of the remote control unlocking buttons:



Short press.

Long press.

or

- ▶ Unlock the vehicle by pressing the driver's door handle.

The monitoring system is also deactivated when the driver approaches the vehicle.

The monitoring system is deactivated: the indicator lamp in the button goes off and the direction indicators flash for about 2 seconds.

#### **I After unlocking using the remote control**

If the vehicle automatically locks itself again (as happens if a door or the boot is not opened within 30 seconds of unlocking), the monitoring system is automatically activated.

## **Locking the vehicle with exterior perimeter monitoring only**

Deactivate the interior volumetric and anti-tilt monitoring to avoid the unwanted triggering of the alarm, in certain cases such as:

- Presence of an occupant or a pet.
- Slightly open window.
- Washing the vehicle.
- Changing a wheel.
- Towing the vehicle.
- Transport on a ship or ferry.

## **Deactivating the interior volumetric and anti-tilt monitoring**

- ▶ Switch off the ignition and within 10 seconds press the alarm button until its red indicator lamp is on fixed.
- ▶ Get out of the vehicle.

- ▶ Immediately lock the vehicle using the remote control or the Keyless Entry and Start system. Only the exterior perimeter monitoring is activated; the button's red indicator lamp flashes once every second.

- I** To take effect, this deactivation must be carried out after each time the ignition is switched off.

## **Reactivating the interior volumetric and anti-tilt monitoring**

- ▶ Deactivate the exterior perimeter monitoring by unlocking the vehicle using the remote control or the Keyless Entry and Start system. The indicator lamp in the button goes off.
- ▶ Reactivate all monitoring by locking the vehicle using the remote control or the Keyless Entry and Start system. The red indicator lamp in the button once again flashes every second.

## **Triggering of the alarm**

This is indicated by sounding of the siren and flashing of the direction indicators for 30 seconds.

Depending on the country of sale, certain monitoring functions remain active until the alarm has been triggered eleven times consecutively. When the vehicle is unlocked using the remote control or the Keyless Entry and Start system, rapid flashing of the red indicator lamp in the

button informs you that the alarm was triggered during your absence. When the ignition is switched on, this flashing stops.

## **Failure of the remote control**

To deactivate the monitoring functions:

- ▶ Unlock the vehicle using the key in the front left-hand door lock.
- ▶ Open the door; the alarm is triggered.
- ▶ Switch on the ignition; this stops the alarm. The indicator lamp in the button goes off.

## **Locking the vehicle without activating the alarm**

- ▶ Lock the vehicle using the key (built-in the remote control) in the front left-hand door lock.

## **Automatic activation**

(Depending on version)

The system is activated automatically 2 minutes after the last door or the boot is closed.

- ▶ To avoid triggering the alarm on entering the vehicle, first press the unlocking button on the remote control or unlock the vehicle using the "Keyless Entry and Start" system.

## **Malfunction**

When the ignition is switched on, the fixed lighting of the red indicator lamp in the button indicates a system malfunction.

Have it checked by a PEUGEOT dealer or a qualified workshop.

## Electric windows

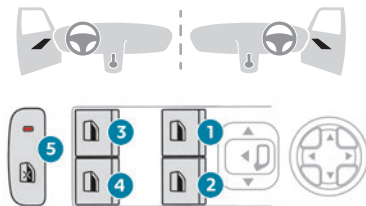

1. Left-hand front
2. Right-hand front
3. Left-hand rear
4. Right-hand rear
5. Deactivation of electric window controls located by rear seats

### Manual operation

► To open/close the window, press/pull the switch without passing the point of resistance; the window stops as soon as the switch is released.

### Automatic operation

► To open/close the window, press/pull the switch past its resistance point: the window opens/closes completely when the switch is released.

Operating the switch again stops the movement of the window.

**i** The electric window controls remain operational for approximately 45 seconds after switching off the ignition. After that time, the controls are disabled. To reactivate them, switch the ignition on again.

### Anti-pinch

If the window meets an obstacle while rising, it stops and immediately partially lowers again.

#### **i** Overtaking of the anti-pinch

After triggering the anti-pinch, check that there are no obstacles blocking the movement of the window.

Try to close the window again.

If the window closing is interrupted by the anti-pinch 3 times in a row (max. 10 seconds between each action), the anti-pinch function becomes inoperable.

Without this protection, the window can only be closed manually - risk of injury!

### Deactivating the rear controls for the rear electric windows



For your children's safety, ignition on or engine on, press control **5** to deactivate the controls for the rear electric windows, irrespective of their positions.

The red indicator lamp in the button comes on.

The rear electric windows can still be controlled using the driver's controls.

### Reinitialising the electric windows

After reconnecting the battery, or in the event of abnormal window movement, the anti-pinch function must be reinitialised.

**i** Automatic window closing is no longer available, only manual closing is possible.

Remote window closing with the electronic key is also no longer available in this case.

#### **The anti-pinch function is inoperable during the following sequence of operations.**

For each window:

- Pull the control until the window is fully closed.
- Release the control, then pull it again for at least one second.

**!** If an electric window meets an obstacle during operation, the movement of the window must be reversed. To do this, press the relevant control.

When the driver operates the passengers' electric window controls, it is important to ensure that nothing can prevent the window from closing properly.

It is important to ensure that passengers use the electric windows correctly.

Pay particular attention to children when operating the windows.  
 Be aware of passengers and/or other persons present when closing windows remotely using the electronic key.  
 Do not put your head or arms through the open windows when the vehicle is moving - risk of serious injury!

## Sunroof

The sunroof consists of a movable glass panel that slides over the roof and a blind that can be opened independently. Opening the sunroof automatically opens the blind.

► To operate the panoramic sunroof, use the button in the roof console.

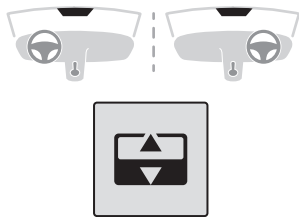

The sunroof can be operated when the ignition is turned on (if the battery is charged enough), with the engine running, in STOP mode of Stop & Start, and up to 45 seconds after turning off the ignition.

## Precautions

! Do not put your head or arms through the sunroof while the vehicle is moving - risk of serious injury!

! Do not operate the sunroof if transverse roof bars are fitted - risk of serious damage!  
 Do not place heavy loads on the movable glass panel of the sunroof.

! If the sunroof is wet, following a rain shower or washing the vehicle, wait until it is completely dry before operating it.  
 Do not operate the sunroof if it is covered by snow or ice - risk of damage!  
 Use only plastic scrapers to remove snow or ice from the sunroof.

! Regularly check the condition of the sunroof seals (e.g. presence of dust, dead leaves).  
 If using a car wash, check first that the roof is correctly closed and keep the high-pressure jet at least 30 centimetres from the seals.

! Never leave the vehicle with the sunroof open.

## Operation

When opening the sunroof fully, the movable glass moves to a partially open position, then slides over the roof. Any intermediate position is possible.

! Before operating the sunroof control button, ensure that no object or person might prevent the movement.

Pay particular attention to children when operating the sunroof.

If something is trapped when operating the sunroof, reverse the movement of the sunroof by pressing the control button in question.

The driver must ensure that passengers use the sunroof correctly.

Any manual intervention on the position of the sunroof may disturb the anti-pinch device. Perform a reinitialisation.

## Anti-pinch system

If the sunroof encounters an obstacle when closing, the movement is automatically reversed.

## Opening/Closing the sunroof

► To open the sunroof, use the part of the button located towards the rear.

► To close the sunroof, use the part of the button located towards the front.

## Operating the button

► Pressing the button beyond its point of resistance opens or closes the sunroof fully.

- ▶ Pressing the button again stops the movement in progress.
- ▶ By keeping the button pressed (without going beyond the point of resistance), the movement of the glass stops when this button is released.
- ▶ When the sunroof is closed: pressing once without passing the point of resistance moves it to the partially open position.

**i** The sunroof and windows can be closed by holding down the remote control locking button.  
Press again to stop the manoeuvre.

### Opening/Closing the blind

- ▶ To open the blind, pull its handle backwards until the desired position is reached.
- ▶ To close the blind, push its handle forwards until the desired position is reached.

## Reinitialisation

Reinitialisation is required after reconnecting the battery, or if the sunroof malfunctions or moves in a jerky manner.

- ▶ Check that nothing is affecting the movement of the sunroof and that the seals are clean.

**i** Automatic sunroof closing is no longer available, only manual closing is possible.  
Remote sunroof closing with the electronic key is also no longer available in this case.



- ▶ With the ignition on, press and hold the front part of the button to close the sunroof.

The sunroof closes step by step. When fully closed, it performs a slight opening/closing movement.

- ▶ Release the button 1 second after the end of the movement.

## Driving position

### Correct seating position

Adopting a good driving position contributes to improving driver comfort and protection. It also optimises interior and exterior visibility as well as access to controls. Certain seat adjustments described in this section depend on the trim level and the country in which the vehicle is sold.

#### Driver's side

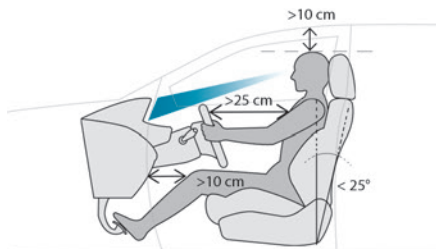

Sit fully back in the seat with your pelvis, back and shoulders in contact with the seat backrest. Adjust the seat cushion height so that your eyes are level with the centre of the windscreen. The head should be at a minimum distance of 10 cm from the roof. Adjust the longitudinal position of the seat so that you can fully depress the pedals with legs slightly flexed.

The distance between the knees and the dashboard should be at least 10 cm, for easy access to the dashboard controls. Adjust the backrest angle to as vertical a position as possible; never tilt it more than 25°. Adjust the head restraint so that its upper edge is level with the top of the head. Adjust the length of the seat cushion to support your thighs. Adjust the lumbar support so that it conforms to the shape of the spine. Adjust the steering wheel reach so that it is at least 25 cm from the sternum and you can hold it with your arms slightly bent. Adjust the steering wheel height so that it does not obstruct the information displayed on the instrument panel.

**!** As a safety precaution, adjust the seats only when the vehicle is stationary.

**i** **Electrically-adjustable seats**  
Switch the ignition on to enable the adjustments to be made.

#### Passenger's side

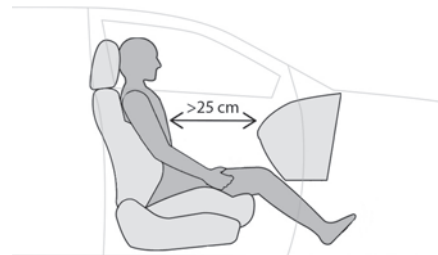

Sit fully back in the seat with the pelvis, back and shoulders in contact with the seat backrest. Adjust the longitudinal position of the seat so that you are at a distance of at least 25 cm from the dashboard. Adjust the head restraint so that its upper edge is level with the top of the head.

#### Before moving off

Adjust the interior and exterior door mirrors to reduce blind spots. Fasten the seat belt: place the diagonal belt in the middle of the shoulder and adjust the lap belt so that it is tightened across the pelvis. Ensure that all passengers have fastened their seat belts correctly.

**i** **Electric door mirrors**  
Switch the ignition on to enable the adjustments to be made.



## When driving

Maintain a good driving position and hold the steering wheel with both hands at the 'quarter to three' position, so that you can easily and quickly reach the controls behind and near the steering wheel.

- ! Never adjust the seats or steering wheel when driving.  
Always keep your feet on the floor.

## Front seats

- ! Before moving the seat backwards, ensure that there is no person or object that might prevent the full travel of the seat. There is a risk of trapping or pinching passengers if present in the rear seats or of jamming the seat if large objects are placed on the floor behind the seat.

## Front head restraints

### Adjusting the height

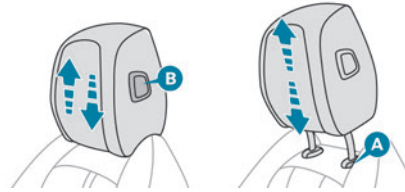

#### Upwards:

- ▶ Pull the head restraint up to the desired position; you can feel the head restraint clicking into position.

#### Downwards:

- ▶ Depending on equipment, press lug **A** or button **B** and then, while still pressing, lower the head restraint.

- i The head restraint is correctly adjusted when its upper edge is level with the top of the head.

### Removing a head restraint

- ▶ Pull the head restraint fully up.
- ▶ Press lug **A** to release the head restraint and raise it fully.
- ▶ Stow the head restraint securely.

### Refitting a head restraint

- ▶ Insert the head restraint rods into the guides in the corresponding seat backrest.
- ▶ Push the head restraint fully down.
- ▶ Press the lug **A** to release the head restraint and push it down.
- ▶ Adjust the height of the head restraint.

- ! Never drive with the head restraints removed; they should be in place and adjusted for the occupant of the seat.

## Manual adjustments

### Longitudinal



- ▶ Raise the control bar and slide the seat forwards or backwards.
- ▶ Release the control bar to lock the seat in position on one of the notches.

## Height



- ▶ Pull the control upwards to raise or push it downwards to lower, until you obtain the position required.

## Backrest angle



- ▶ Turn the knob to obtain the desired angle.

## Lumbar



- ▶ Turn the knob to obtain the desired level of lumbar support.

## Seat cushion length

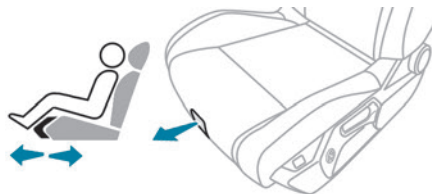

- ▶ Pull the handle forwards to release the cushion, then move the front part of the cushion forwards or backwards.

## Electric adjustments

### Longitudinal



- ▶ Push the control forwards or backwards to slide the seat.

## Cushion height and angle

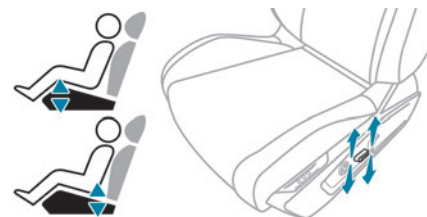

- ▶ Tilt the rear of the control upwards or downwards to obtain the required height.
- ▶ Tilt the front of the control upwards or downwards to obtain the required angle.

### Backrest angle



- ▶ Tilt the control forwards or rearwards.

## Lumbar



The control allows independent adjustment of the depth and vertical position of the lumbar support.



▶ Press and hold the front or rear of the control to increase or reduce the lumbar support.

▶ Press and hold the top or bottom of the control to raise or lower the lumbar support area.

## Seat cushion angle

This electric adjustment control is present on "AGR" certified manually-adjustable seats.

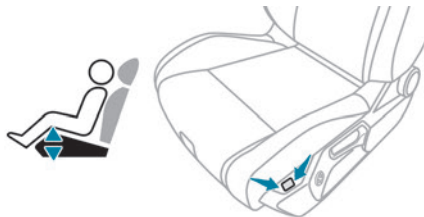

▶ Press and hold the front or rear of the button to raise or lower the front part of the seat cushion.

## Memorising driving positions

Associated with the electrically-adjusted driver's seat, this function allows two driving positions to be memorised, to make these adjustments easier if there are frequent driver changes.

It records the electric adjustments made to the seat and door mirrors.

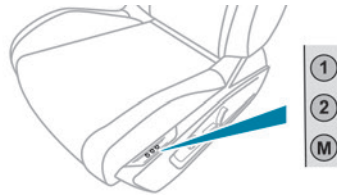

### Using buttons 1/2/M

- ▶ Enter the vehicle and switch the ignition on.
- ▶ Adjust the seat and the door mirrors.
- ▶ Press button **M**, then press button **1** or **2** within 4 seconds.

An audible signal confirms the memorisation. Memorising a new position cancels the previous position.

### Recalling a stored position

**!** While the seat is moving, take care that no person or object hinders the automatic movement of the seat.

### With the ignition on or engine running

▶ Press button **1** or **2** to recall the corresponding position.

An audible signal sounds when adjustment is complete.

You can interrupt the current movement by pressing button **M**, **1** or **2** or by using one of the seat adjustment controls.

A stored position cannot be recalled while driving.

The recalling of stored positions is deactivated 45 seconds after switching off the ignition.

## Heated seats

### Without i-Toggles

#### On/Off



- ▶ Press the button corresponding to the seat.
- ▶ Each press changes the heating level; the corresponding number of indicator lamps come on.
- ▶ To switch off the heating, press the button until all of the indicator lamps are off.

The system status is memorised when the ignition is switched off.

## With i-Toggles

### Activation/Deactivation



In the **Seats** touch screen application, select the **Seats** tab.

- ▶ Select the driver or passenger seat.

The corresponding page is displayed with the last memorised settings.



If the settings are suitable, press to activate/deactivate the function in the **Seats** application.

If no action is taken, the display returns to its initial state.

The function status is not memorised when the ignition is switched off.

### Changing settings

- ▶ In the **Seats** page, select the seat concerned.
- ▶ Select an intensity from the three preset levels: "1" (Low), "2" (Normal) or "3" (High). The settings are memorised when the ignition is switched off.



Do not use the function when the seat is not occupied.

Reduce the heating intensity as soon as possible.

When the seat and passenger compartment have reached a satisfactory temperature, switch the function off; reducing electrical

consumption in turn decreases energy consumption.



Prolonged use of heated seats is not recommended for people with sensitive skin.

There is a risk of burns for people whose perception of heat is impaired (e.g. illness, taking medication).

To keep the heated pad intact and to prevent a short circuit:

- Do not place heavy or sharp objects on the seat.
- Do not kneel or stand on the seat.
- Do not spill liquids onto the seat.
- Never use the heating function if the seat is damp.

## Multipoint massage

System with a choice of type of massage and adjustment of its intensity.

This system operates with the engine running, as well as in STOP mode of the Stop & Start.

### Activation/Deactivation



In the **Seats** touch screen application, select the **Message** tab.

- ▶ Select the driver or passenger seat.

The corresponding page is displayed with the last memorised settings.



If the settings are suitable, press to activate/deactivate the function in the **Seats** application.

If no action is taken, the display returns to its initial state.

The function status is not memorised when the ignition is switched off.

### Changing settings

- ▶ In the **Message** page, select the seat concerned.
- ▶ Select a message intensity from the three preset levels: "1" (Low), "2" (Normal) or "3" (High).
- ▶ Select another type of massage from those offered.

The modifications are taken into account immediately and memorised when the ignition is switched off.

Once activated, the system starts a one hour message cycle, made up of sequences of 6 minutes of massage followed by 3 minutes at rest.

The system stops automatically at the end of the cycle.

## Steering wheel adjustment

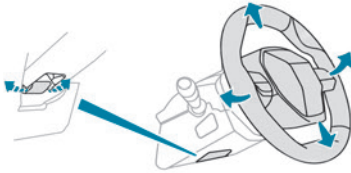

- ▶ When stationary, pull the control to release the steering wheel.
- ▶ Adjust the height and reach to suit your driving position.
- ▶ Push the control to lock the steering wheel.

**!** For safety reasons, these adjustments must only be carried out with the vehicle stationary.

**i** **PEUGEOT i-Cockpit®**  
The instrument panel information is visible above the steering wheel, for greater safety and driving comfort. Adjust the steering wheel height so that it does not obstruct the instrument panel.

## Heated steering wheel

In cold weather, this function heats the circular part of the steering wheel.

It can be activated when the outside temperature is below 20°C.

### Without i-Toggles

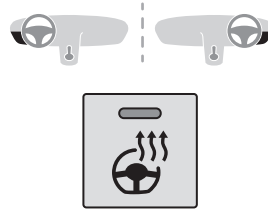

- ▶ With the engine running, press this button to activate/deactivate the function (confirmed by the indicator lamp coming on/going out). The system is automatically deactivated every time the engine is switched off.

### With i-Toggles



In the **Climate** touch screen application, select the **Seats and Steering Wheel** tab.



Press to activate/deactivate the function. The function is memorised each time the engine is switched off.

## Mirrors

### Door mirrors

#### Demisting/Defrosting



The demisting/defrosting of the door mirrors works with the demisting/defrosting of the rear screen.

For more information on **Rear screen demisting/defrosting**, refer to the corresponding section.

**!** As a safety measure, the mirrors should be adjusted to reduce the "blind spots".

The objects that you see in the mirrors are in fact closer than they appear. Take this into account in order to correctly judge the distance of vehicles approaching from behind.

## Adjustment

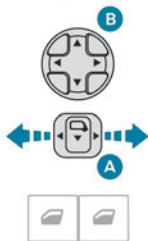

- ▶ Move control **A** to the right or to the left to select the corresponding mirror.
- ▶ Move control **B** in any of the four directions to adjust.
- ▶ Return control **A** to its central position.

## Manual folding

The mirrors can be folded manually (parking obstruction, narrow garage, etc.).

- ▶ Turn the mirror towards the vehicle.

## Electric folding

Depending on equipment, the door mirrors can be folded electrically.



- ▶ From the inside, with the ignition on, place control **A** in the central position.
- ▶ Pull control **A** backwards.

- ▶ Lock the vehicle from the outside.

**i** If the mirrors are folded using control **A**, they will not unfold when the vehicle is unlocked.

## Electric unfolding

- ▶ From outside: unlock the vehicle.
- ▶ From inside: with the ignition on, place control **A** in the central position and then pull it rearwards.

**i** The automatic folding/unfolding of the door mirrors is configured in the **Settings > Vehicle** touch screen application. Before using an automatic car wash, fold the mirrors.

## Automatic tilting in reverse gear

Depending on version, this function allows you to automatically tilt the mirrors downwards to assist with parking manoeuvres in reverse gear.

With the engine running, on engaging reverse gear, the mirror glasses tilt downwards.

They each return to their original positions:

- A few seconds after coming out of reverse gear.

- Once the vehicle speed exceeds 6 mph (10 km/h).

- When the engine is switched off.

 It can be activated/deactivated in the **Settings > Vehicle** touch screen application.

## Electrochromic interior rear view mirror

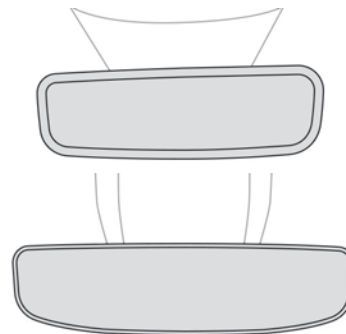

The electrochromic system uses a sensor that detects the level of exterior brightness and that coming from the rear of the vehicle, in order to automatically and gradually switch between day and night usage.

**i** To ensure optimum visibility while manoeuvring, the mirror automatically brightens when reverse gear is engaged. The system is inoperative if the load in the boot exceeds the height of the load space

cover or if the load space cover has items placed on it.

## Rear bench seat

### Rear head restraints

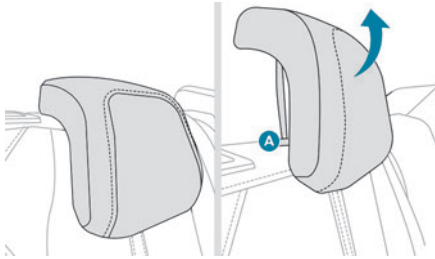

They have two positions:

- A **high position**, for when the seat is in use:
  - ▶ Pull the head restraint fully up.
- A **low position**, for stowing, when the seat is not in use:
  - ▶ Press the lug **A** to release the head restraint and push it down.

The rear head restraints can be removed.

#### Removing a head restraint

- ▶ Release the backrest using control **1**.
- ▶ Tilt the backrest slightly forwards.
- ▶ Pull the head restraint fully up.
- ▶ Press the lug **A** to release the head restraint and remove it completely.

#### Refitting a head restraint

- ▶ Insert the head restraint rods into the guides in the corresponding backrest.
- ▶ Push the head restraint fully down.
- ▶ Press the lug **A** to release the head restraint and push it down.

**!** Never drive with passengers seated at the rear when the head restraints are removed; the head restraints should be in place and in the high position. The head restraint for the centre seat and those for the outer seats are not interchangeable.



#### Folding the backrests

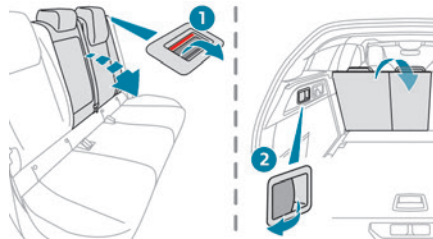

Each section of the backrest has one or two release controls:

- A grip **1** on the outer edge of the backrest.
- A lever **2** on the boot side trim (SW).

**!** The backrests should only be manoeuvred when the vehicle is stationary.

First steps:

- ▶ Lower the head restraints, or remove them when carrying heavy loads.
- ▶ Lift up the rear armrest.
- ▶ If necessary, move the front seats forward.
- ▶ Check that no person or object might interfere with the folding of the backrests (e.g. clothing, luggage).
- ▶ Check that the outer seat belts are lying flat on the backrests.

**i** The folding of the backrest is accompanied by a slight lowering of the corresponding cushion.

To obtain a flat surface, it is necessary to place the adjustable boot floor in the high position.

When the backrest is released, the red indicator in the release grip is visible.

## From the passenger compartment

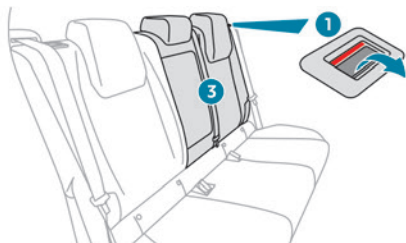

- ▶ Press backrest release handle 1.

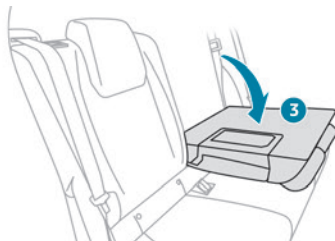

- ▶ Guide the backrest 3 down to the horizontal position.

## From the boot (SW)

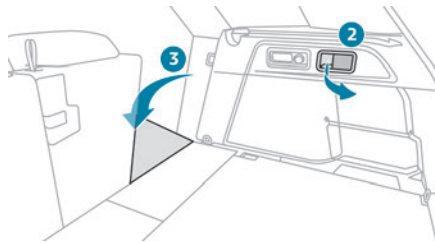

- ▶ Pull the backrest release lever 2 towards you. The backrest 3 folds fully onto the cushion.

**i** On the left-hand side, the lever is also used for folding down the central section of the backrest.

## Central backrest (SW)

The central section of the backrest may be folded down independently of the side sections.



- ▶ Check in advance that the rear armrest is not folded down and that the central head restraint is not raised.

- ▶ From inside the passenger compartment or from the boot, pull on the strap to release.
- ▶ Fold the backrest onto the seat cushion.
- ▶ When repositioning, lift up the backrest fully until it locks.

## Repositioning the backrests

**!** First check that the outer seat belts are lying vertically flat alongside the backrest latching rings.

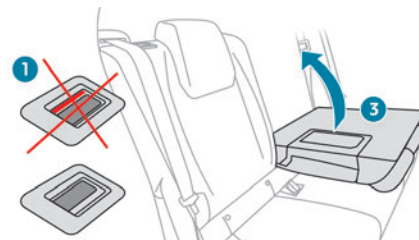

- ▶ Straighten the backrest 3 and push it firmly to latch it into place.
- ▶ Check that the red indicator is no longer visible in the release grip 1.
- ▶ Ensure that the outer seat belts were not trapped during the operation.

**!** Please note: an incorrectly latched backrest compromises the safety of passengers in the event of sudden braking or an accident. The contents of the boot may be thrown forwards - risk of serious injury!



## Heating and Ventilation

### Air intake

The air circulating in the passenger compartment is filtered and originates either from the exterior, via the grille located at the base of the windscreen, or from the inside in air recirculation mode.

### Controls



Depending on version, certain controls are accessible in the **Climate** touch screen application and/via the control panel on the centre console.

### Air distribution

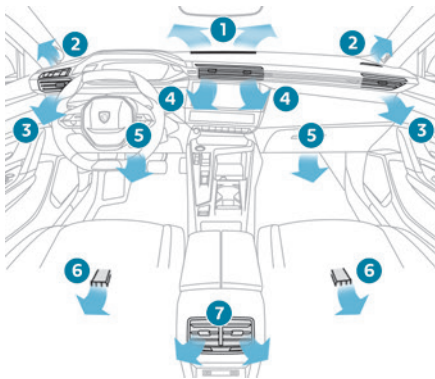

1. Windscreen demisting/de-icing vents
2. Front side window demisting/de-icing vents

3. Adjustable and closable side air vents
4. Adjustable and closable central air vents
5. Air outlets to the front footwells
6. Air outlets to the rear footwells
7. Adjustable and closable air vents

## Advice

### Using the ventilation and air conditioning system

- ▶ To ensure that air is distributed evenly, keep the external air intake grilles at the base of the windscreen, the nozzles, the vents, the air outlets and the air extractor in the boot free from obstructions.
  - ▶ Do not cover the sunshine sensor located on the dashboard; this sensor is used to regulate the automatic air conditioning system.
  - ▶ Operate the air conditioning system for at least 5 to 10 minutes once or twice a month to keep it in good working order.
  - ▶ If the system does not produce cold air, switch it off and contact a PEUGEOT dealer or a qualified workshop.
- When towing a large load on a steep gradient in high temperatures, switching off the air conditioning increases the available engine power, enhancing the towing capacity.

- ! Avoid driving for too long with the ventilation off or with prolonged operation

of interior air recirculation. Risk of misting and deterioration of the air quality!



If the interior temperature is very high after the vehicle has stood for a long time in the sunshine, air the passenger compartment for a few moments. Put the air flow control at a setting high enough to quickly change the air in the passenger compartment.

Condensation created by the air conditioning results in a discharge of water underneath the vehicle. This is perfectly normal.

### Servicing the ventilation and air conditioning system

- ▶ Ensure that the passenger compartment filter is in good condition and have the filter elements replaced regularly. We recommend using a composite passenger compartment filter. Its specific active additive helps protect against polluting gases and bad smells.
- ▶ To ensure correct operation of the air conditioning system, have it checked according to the recommendations in the Manufacturer's service schedule.

### Stop & Start / e-Auto mode

The heating and air conditioning systems only operate when the engine is running. Temporarily deactivate the corresponding system to maintain a comfortable temperature in the passenger compartment. For more information, refer to the corresponding section.

### Rechargeable hybrid vehicles

Intensive use of the air conditioning reduces the vehicle range in **Electric** mode.

### Electric vehicles

Selecting the **ECO** driving mode reduces electrical energy consumption, but restricts the performance of the heating and air conditioning systems, although it does not deactivate them.

## Ventilation with the ignition on

When the ignition is switched on, the ventilation system and the air flow **2** and air distribution **3** settings in the passenger compartment are activated, for a period which depends on the battery charge.

This function does not include the air conditioning system.

## Dual-zone automatic air conditioning

This system automatically controls the activation of the air conditioning system, regulating the temperature, air flow and air distribution inside the passenger compartment.

This system works with the engine running, but access to the ventilation and its controls remains possible with the ignition on.

 Press the **Climate** application button to display the system controls page.

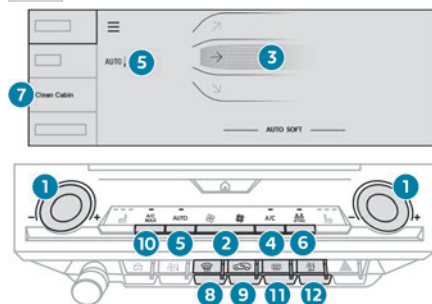

### Without i-Toggles



### With i-Toggles

1. Temperature adjustment
2. Air flow adjustment
3. Air distribution adjustment
4. Air conditioning on/off
5. Automatic air conditioning on/off and setting (AUTO SOFT/AUTO NORMAL/AUTO FAST)
6. Driver/front passenger temperature synchronisation
7. AQS function only or Clean Cabin (depending on version).
8. Front demisting/de-icing
9. Interior air recirculation
10. Maximum A/C (depending on version)
11. Rear screen demisting/de-icing
12. Switching the system off

## Temperature adjustment

The driver and front passenger can each choose their own temperature setting.

The value indicated corresponds to a level of comfort and not to a precise temperature.

Depending on version:

- Turn one of the knobs **1** towards + or - to increase or decrease the value.

► Press one of the buttons **1** (+ or -) or drag vertically to increase or decrease the value. It is possible to go beyond the minimum and maximum values by selecting respectively **Low** or **High**.

It is recommended that you avoid a difference of more than 3°C in the settings for left and right.

## Temperature synchronisation

The driver side temperature setting is applied to the passenger side.

► Press button **6-SYNC** to activate/deactivate the function.

The function is automatically deactivated if the passenger uses their temperature adjustment buttons.

## Automatic air conditioning

This automatic mode ensures optimum management of the passenger compartment temperature, air flow and air distribution, based on the selected comfort level.

► Press button **5-AUTO** to activate/deactivate the automatic mode of the air conditioning system.

The indicator lamp in the button lights up when the air conditioning system is operating automatically.

The intensity of the automatic air conditioning is modulated by choosing one of the following settings:

- **AUTO SOFT**: provides soft and quiet operation by limiting air flow.
  - **AUTO NORMAL**: offers the best compromise between a comfortable temperature and quiet operation (default setting).
  - **AUTO FAST**: provides dynamic and efficient air distribution.
- To change the AUTO mode, press button **5-AUTO** successively.
- To ensure passenger comfort in the rear seats, favour settings **AUTO NORMAL** and **AUTO FAST**.

**i** In cold weather with the engine cold, the air flow is increased gradually until the comfort setting has been reached, in order to limit the delivery of cold air into the passenger compartment.

On entering the vehicle, if the interior temperature is much colder or warmer than the comfort setting requested, there is no need to alter the value displayed to more quickly reach the required level of comfort. The system automatically corrects the temperature difference as quickly as possible.

## Automatic air conditioning manual settings

It is possible to manually adjust one or more of these functions, while the system retains automatic control of the other functions:

- air flow.

- air distribution.

The indicator lamp in the "**AUTO**" button goes out if a setting is changed.

► Press button **5-AUTO** again to reactivate automatic air conditioning.

## Adjusting the air flow

Depending on version:

► Press one of the buttons **2 (fan)** to decrease or increase the air flow.

► Press one of the buttons **2 (fan)** or drag horizontally to increase or decrease air flow.

It is also possible to directly press one of the values.

### **i** Switching off the air conditioning system

When the air flow is reduced to a minimum, ventilation stops.

"**OFF**" is displayed alongside the fan.

## Adjusting the air distribution

► Press the buttons **3** to adjust the air flow distribution inside the passenger compartment.

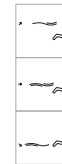

Windscreen and side windows

Central and side air vents

Footwells

A symbol is activated to display the presence of blown air in the direction indicated.

It is possible to activate all three buttons simultaneously, for uniform distribution throughout the passenger compartment.

## Clean Cabin function

It includes the AQS (Air Quality System) and Clean Air functions.

► To activate/deactivate the function, press button 7.

### AQS function

Using an exterior pollution sensor, this function automatically activates the recirculation of interior air when a certain level of pollutants in the exterior air is detected.

When the air quality returns to a satisfactory level, recirculation of interior air is automatically deactivated.

This function is not designed to detect unpleasant odours.

Recirculation is automatically activated when the windscreen wash is used or when reverse gear is engaged.

The function is inactive if the outside temperature is below 5°C to prevent the risk of misting on the windscreen and side windows.

### Clean Air function

Using an interior pollution sensor, this function detects fine particles (e.g. cigarette smoke, mould, bacteria).

The management of the recirculation of interior air makes it possible to return to a purified passenger compartment in just a few minutes,

thanks to the passage of air through the high-performance passenger compartment filter. If the air quality appears to be reduced, contact a PEUGEOT dealer or a qualified workshop to change the high-performance passenger compartment filter.

## Air conditioning on/off

The air conditioning system is designed to operate effectively in all seasons, with the windows closed:

- It lowers the temperature in summer.
- It increase the effectiveness of the demisting, in winter, above 3°C.

► Press button **4-A/C** to switch the air conditioning on/off.

When the system is switched on, the indicator lamp in the button comes on or “**A/C**” changes colour (depending on version).

**i** Air conditioning does not operate when the air flow is deactivated.

To obtain cool air more quickly, enable interior air recirculation for a brief period. Then return to the intake of exterior air.

Switching off the air conditioning may result in some discomfort (humidity or misting).

## Maximum air conditioning

This function automatically adjusts the temperature setting to the lowest possible, the air distribution towards the central and side air

vents, the air flow to maximum and, if necessary, activates interior air recirculation.

 ► Press this button to activate/deactivate the function (confirmed by the illumination/extinction of the indicator lamp). Once the function is deactivated, the system returns to the previous settings.

## Switching off the air conditioning system

► Press button **12-OFF**.

Its indicator lamp lights up and all the other indicator lamps of the air conditioning system go off.

This action deactivates all of the functions of the air conditioning system.

The temperature is no longer regulated. A slight flow of air can still be felt, due to the forward movement of the vehicle.

## Interior air recirculation

The intake of exterior air prevents the formation of mist on the windscreen and side windows. Recirculating the interior air isolates the passenger compartment from outside odours and fumes and allows the desired passenger compartment temperature to be achieved more rapidly.

 ► Press this button to activate/deactivate the function (confirmed by the illumination/extinction of the indicator lamp).

**i** This function is activated automatically when the front screenwash is used or reverse gear is engaged.

## Front demisting/defrosting

This mode allows the windscreen and side windows to be demisted or defrosted as quickly as possible.



▶ Press this button to activate/deactivate the mode (confirmed by the illumination/extinction of the indicator lamp).

The mode automatically manages the air conditioning, air flow, air intake and distributes ventilation optimally to the windscreen and side windows.

The air flow can be changed manually without deactivating this mode.

**i** With Stop & Start, when demisting has been activated, STOP mode is not available.

**!** In wintry conditions, before moving off, it is essential to remove any snow or ice from the windscreen around the camera. Otherwise, the operation of the equipment using the camera may be affected.

## Rear screen demisting/defrosting

This demisting/de-icing only works with the engine running. Depending on version, it also demists/de-ices the door mirrors.



▶ Press this button to activate/deactivate the function (confirmed by the indicator lamp coming on/switching off).

The function can be activated whatever the outside temperature may be.

The period of operation depends on the outside temperature.

Demisting/defrosting therefore switches off automatically to prevent an excessive consumption of electrical current.

## Heated windscreen

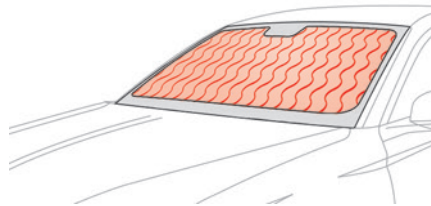

In cold weather, this function heats the entire windscreen and complements the Automatic Visibility programme to speed up the evacuation of elements that interfere with visibility (e.g. dew,

mist, frost, snow), located on either side of the windscreen.

It can be used both before setting off and while driving.

## Switching on/off



▶ With the engine running, press this button to activate/deactivate the function (confirmed by an indicator lamp).

The period of operation depends on the outside temperature.

The function switches off automatically to prevent excessive power consumption.

## Temperature pre-conditioning (Rechargeable hybrid or Electric)

This function allows you to programme the temperature in the passenger compartment to reach a pre-defined, non-modifiable temperature

(approx. 21°C) before you enter the vehicle, on the days and at the times of your choice. This function is available when the vehicle is connected or not connected.

## Programming



In the **Climate** touch screen application, select the **Preconditioning** tab.

- ▶ Press **+** to add a programme.
- ▶ Select the time of entry into the vehicle and the desired days. Press **OK**.
- ▶ Press **ON** to activate this programming. The pre-conditioning sequence begins approximately 45 minutes before the programmed time when the vehicle is connected (20 minutes when it is not connected) and is maintained for 10 minutes after.



For rechargeable hybrid vehicles, this indicator lamp comes on fixed when a temperature pre-conditioning cycle is programmed. It flashes when temperature pre-conditioning is in progress.

- i** You can set multiple programmes. Each one is saved in the system.

To optimise the driving range, we recommend starting a programme while the vehicle is connected.



The programming can also be carried out from a smartphone via the **MYPEUGEOT APP** application.

For more information on **Remotely operable additional functions**, refer to the corresponding section.

- i** The fan noise that occurs during temperature pre-conditioning is perfectly normal.

### **i** Vehicles equipped with an alarm system

Depending on version, interior volumetric and anti-tilt monitoring may be reduced or even suspended during temperature pre-conditioning sequences.

## Operating conditions

- The function is only activated when the **ignition is switched off** and the **vehicle locked**.
- When the vehicle is not connected, the function is only activated if the battery charge level is greater than 20% (Rechargeable hybrid) or 30% (Electric).
- When the vehicle is not connected and a recurring programme is active (e.g. from Monday to Friday), if two temperature pre-conditioning

sequences are run without the vehicle being used, the programme will be deactivated.

## Front fittings

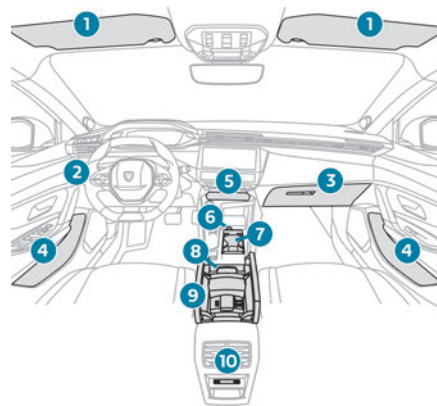

1. Sun visor
2. Coin holder (depending on version)
3. Illuminated glove box
4. Door pockets
5. Storage compartment or Wireless smartphone charger
6. Front USB socket/12 V socket
7. Cup holder
8. Storage compartment or Smartphone storage

9. Front armrest with storage (depending on version)  
Front USB socket (depending on version)
10. Rear USB sockets (depending on version)

## Sun visor

► With the ignition on, raise the concealing flap; depending on the version, the mirror is illuminated automatically.

This sun visor is also equipped with a ticket holder.

## Glove box

► To open the glove box, lift the handle.

With the ignition on, the glove box is lit when open.

Depending on version, it contains an adjustable ventilation nozzle, distributing the same conditioned air as the vents in the passenger compartment.

**!** Never drive with the glove box open when a passenger is at the front. It may cause injury during sharp deceleration!

## 12 V accessory socket

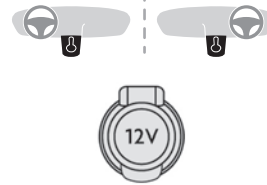

► Plug in a 12 V accessory (with a maximum rated power of 120 W) using a suitable adapter.

**!** Observe the maximum power rating to avoid damaging the accessory.

**!** The connection of an electrical device not approved by PEUGEOT, such as a USB charger, may adversely affect the operation of vehicle electrical systems, causing faults such as poor radio reception or interference with displays in the screens.

## USB sockets

These symbols determine the type of use of a USB socket:



Power supply and recharging.



Likewise, plus exchange of multimedia data with the audio system.



Likewise, plus use of smartphone applications with the touch screen.

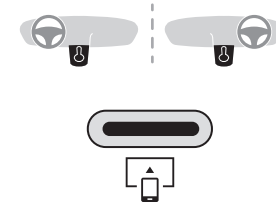

USB sockets allow the connection of a portable device.



The USB socket located at the front of the centre console also allows a smartphone to be connected by Android Auto® or CarPlay®, enabling certain smartphone applications to be used on the touch screen. For best results, use a cable made or approved by the device manufacturer.

These applications can be managed using the steering-mounted controls or the audio system controls.



When the USB socket is used, the portable device charges automatically.

While charging, a message is displayed if the power drawn by the portable device exceeds the current supplied by the vehicle.

For more information about how to use this equipment, refer to the sections describing the audio and telematics systems.

## Wireless smartphone charger

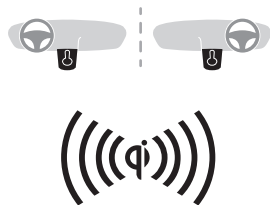

This system allows wireless charging of a portable device such as a smartphone, using the magnetic induction principle, in accordance with the Qi 1.1 standard.

The portable device to be charged must be compatible with the Qi standard, either by design or by using a compatible holder or shell.

A mat can also be used provided that it is approved by the Manufacturer.

The charging area is identified by the Qi symbol.

The charger works with the engine running and with the Stop & Start system in STOP mode.

Charging is managed by the smartphone.

With the Keyless Entry and Start system, the charger's operation may be briefly disrupted when a door is opened or the ignition is switched off.

### Charging

- With the charging area clear, place a device in its centre.



When the portable device is detected, the charger's indicator lamp lights up green. It remains lit for the whole time that the battery is being charged.

! The system is not designed to charge multiple devices simultaneously.

! Do not leave metal objects (e.g. coins, keys, vehicle remote control) in the charging area while a device is being charged - Risk of overheating or interrupting the charging!



! When using applications for a long time in combination with wireless charging, some smartphones may switch to thermal safety and cause some functions to stop.

### Checking operation

The state of the indicator lamp allows the operation of the charger to be monitored.

State of the indicator lamp	Meaning
Off	Engine switched off. No compatible devices detected. Charging complete.
Fixed green	Compatible portable device detected. Charging.
Flashing orange	Foreign object detected in the charging zone. Portable device not well centred in the charging zone.
Fixed orange	Malfunction of the portable device's battery meter. Device battery temperature too high. Charger malfunction.



If the indicator lamp is fixed orange:

- remove the device, then place it back in the centre of the charging zone.

or

- remove the device and try again in a quarter of an hour.

If the problem persists, have the system checked by a PEUGEOT dealer or a qualified workshop.



## Front armrest

It includes a storage space and is illuminated when the cover is opened (depending on version).

### Opening

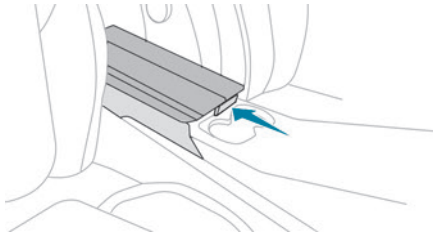

- ▶ Press the lever beneath the cover. The cover opens in two parts.

### Closing

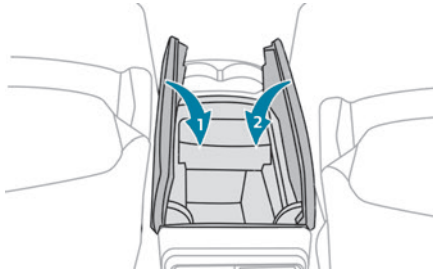

- ▶ Fold back the two parts of the cover.

## FOCAL® Hi-Fi system

The vehicle is equipped with a high-fidelity audio system from the French brand FOCAL®.

10 speakers incorporating exclusive FOCAL® technologies offer the pleasure of special musical experience inside the vehicle:

- 12 channel full active amplification - 690 Watts Class D booster technology: significant audio power available at all times despite low power consumption.
- Polyglass central speaker: sound immersion and spatialisation.
- Polyglass woofers/mid-range speakers with TMD suspension: balance, dynamics and precision of sound.
- Aluminium TNF inverted dome tweeter: optimal sound dispersion, detailed treble.
- Subwoofer with high excursion Power Flower™ triple coil: deep and controlled reproduction of low frequencies.

Two customisable listening modes are available:

- "All passengers": an optimised service for each occupant of the vehicle, both front and rear.
- "Optimised for the front": an immersive and augmented experience, shared between the driver and the front passenger.

## Mats

### Fitting

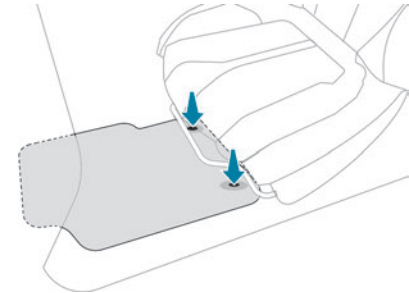

When fitting it on the driver's side, only use the mountings present on the carpet (a "click" indicates proper locking). The other mats are simply laid over the carpet.

### Removing/refitting

- ▶ To remove it on the driver's side, move the seat backwards and unclip the fasteners.
- ▶ To refit it, position the mat and secure it by pressing down.
- ▶ Check that the mat is secured correctly.

**!** To avoid any risk of jamming the pedals:

- Only use mats which are suited to the fixings already present in the vehicle; these fixings must be used.
- Never fit one mat on top of another.

The use of mats not approved by PEUGEOT may interfere with access to the pedals and

hinder the operation of the cruise control/speed limiter.

The approved mats have two fasteners located underneath the seat.

## Courtesy lamps

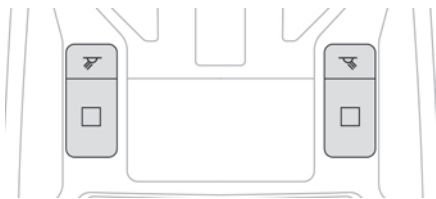

## Reading lamps

▶ With the ignition on, operate the corresponding switch.



Do not place anything against the courtesy lamps.

## Interior ambient lighting

The interior ambient lighting casts soft, coloured lighting in the passenger compartment, when low lighting conditions are detected.

By default, the colour of the interior ambient lighting is linked to that of the screens, depending on the driving mode selected.



Activation/deactivation and adjustment of the brightness are set via the **Settings >**

**Brightness** touch screen application.

The colour is selected via the **Settings > Customization** touch screen application.

## Rear fittings

### USB sockets

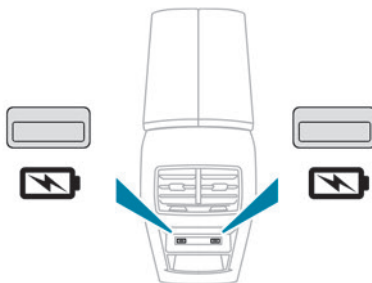

Each USB socket is used only to power or recharge a portable device.

## Rear armrest



The armrest incorporates two cup holders.

The cup holders have a removable reducer to be used depending on the diameter of the cans and cups.

The pen holder can also hold a smartphone.

## Ski flap (Hatchback)

Device for storing and transporting long objects.

### Opening

▶ With the rear armrest lowered, open the flap by pulling its handle downwards.

On the SW version, the ski flap is replaced by the folding of the central backrest.

For more information on the **Rear bench seat**, in particular the central backrest, refer to the corresponding section.



► Load the objects from inside the boot.

## Shark fin antenna

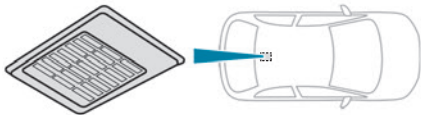

A ventilation grille is present at the rear of the roof for cooling the shark fin antenna. Any ventilation noise produced, with the ignition on or the engine running, is completely normal.

## Boot fittings

### Hatchback

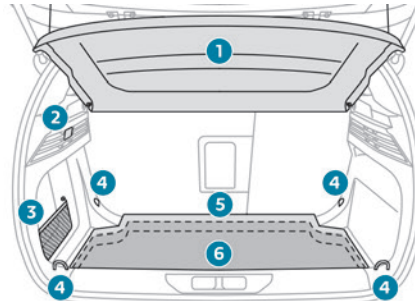

1. Load space cover shelf
2. Boot lamp
3. Storage net
4. Stowing rings
5. Rigid boot floor or hinged boot carpet (Rechargeable hybrid or Electric)
6. Storage well under the carpet

### SW

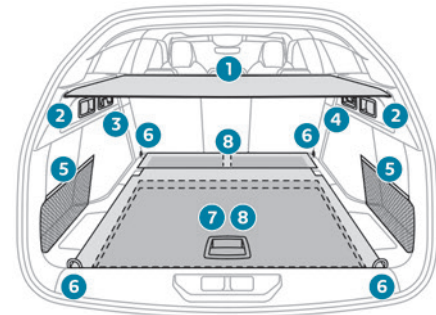
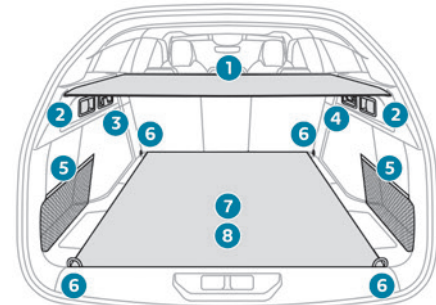

1. Load space cover roller
2. Rear seat folding controls
3. Bag hook
4. 12 V socket  
Boot lamp
5. Storage nets

6. Stowing rings
7. Rigid boot floor, 2-position boot floor or hinged boot carpet (Rechargeable hybrid or Electric)
8. Storage well under the carpet

**i** The stowing rings are designed to secure luggage using different types of retaining nets or suitable straps.

For more information, contact a PEUGEOT dealer or a qualified workshop.

## Load space cover (SW)

**!** In the event of sudden deceleration, objects placed on the load space cover can turn into projectiles.

### Reeling in

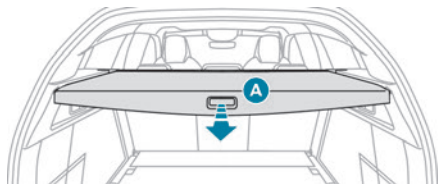

► Pull the handle towards you and downwards; the load space cover will automatically roll up. The moving part **A** can be folded against the backrests of the rear seats.

### Removal

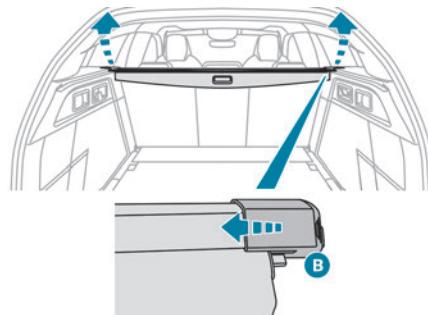

► Compress the control **B** and lift the load space cover on the right then on the left to remove it.

### Storage

A recess located underneath the boot floor can be used to store the load space cover:

- diagonally with the rigid boot floor.
- crosswise with the 2-position boot floor.

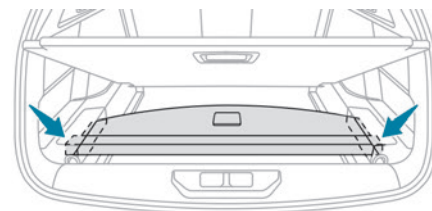
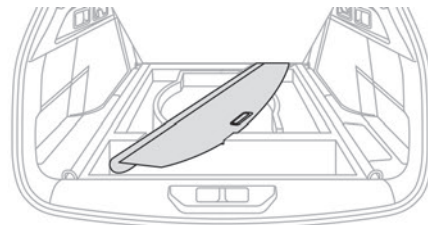

► With the 2-position boot floor, first remove the 2 covers on each side of the housing.

### Installation

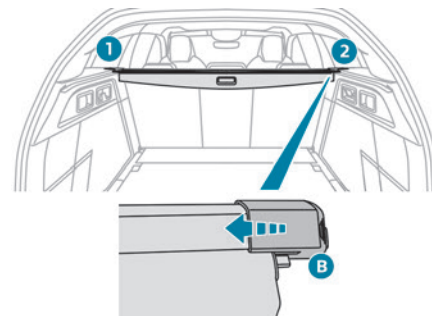

- Position the left-hand end of the load space cover roller in its location **1** behind the rear left seat.
- Compress the roller control **B** and put the roller in place in its location **2** on the right.
- Release the control to secure the load space cover.
- Unroll it until it clips on the boot pillars.

## High load retaining net (SW)

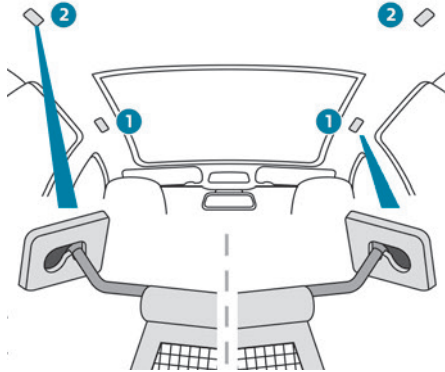

Hooked onto the special upper and lower fixings, this removable net allows the use of the entire loading volume up to the roof:

- behind the front seats (row 1) when the rear seats are folded,
- behind the rear seats (row 2) when the load space cover is removed.

**!** It protects the occupants in case of sudden braking.

## Behind the front seats

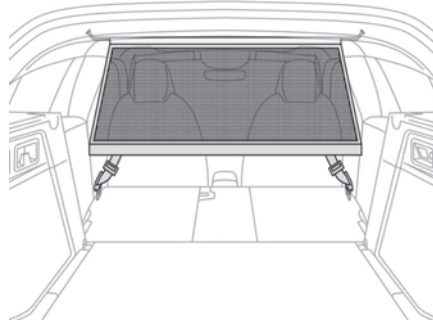

- ▶ Fold down the rear bench seat
- ▶ Insert the ends of the bar, one after the other, into the fixing points in the roof.
- ▶ Attach the net's straps to the lower anchoring points, located on the fixings of the rear bench seat backrest.
- ▶ Pull on the straps to stretch the net.

## Behind the rear bench seat

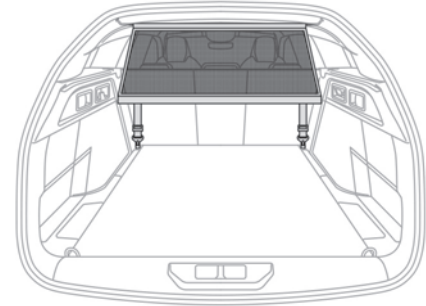

- ▶ Remove the load space cover roller.
- ▶ Insert the ends of the bar, one after the other, into the fixing points in the roof.
- ▶ Attach the straps of the net to the lower rings, located on each side trim of the boot.
- ▶ Pull on the straps to stretch the net.

## 2-position boot floor (SW)

(Depending on version)

This 2-position floor allows the boot volume to be optimised using the lateral stops located on the sides:

- High position (**100 kg max.**): to obtain a flat floor up to the front seats, when the rear seats are folded down.
- Low position (**150 kg max.**): maximum boot volume.

**i** On certain versions, the adjustable boot floor cannot be fitted in the low position.

To change the height:

- ▶ Lift and pull the floor towards you using its central handle, then use the lateral stops to move it.
- ▶ Push the floor all the way forwards to place it in the desired position.

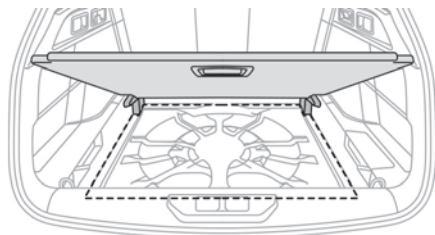

To keep it in the inclined position:

- ▶ From the high position, lift the floor towards the load space cover.
- ▶ Engage it in the inclined position in the lateral stops to secure it in this position.

## 12 V accessory socket

- ▶ To connect a 12 V accessory (maximum power: 120 W), lift the cover and plug in a suitable adaptor.
- ▶ Switch on the ignition.

**!** The connection of an electrical device not approved by PEUGEOT, such as a USB charger, may adversely affect the operation of vehicle electrical systems, causing faults such as poor radio reception or interference with displays in the screens.

## Boot lamp

It comes on automatically when the boot is opened and goes off automatically when the boot is closed.

The lighting time varies according to the circumstances:

- When the ignition is off, approximately 10 minutes.
- In energy saving mode, approximately 30 seconds.
- With the engine running, unlimited.

## Storage well

- ▶ Lift the rigid boot floor as far as possible or lift the hinged boot carpet (depending on version) to access the storage well.
- ▶ With the 2-position boot floor (SW), lift the boot floor as far as possible or lift the cover at the back of the boot to access one or other of the storage wells.

The cover at the back of the boot is also accessible from the second row seats if the backrests of the rear bench seat are folded down.

Depending on version, it includes:



- A hazard warning triangle.
- A temporary puncture repair kit with the tool kit.
- A spare wheel with the tool kit.
- The traction battery charging cables (Rechargeable hybrid or Electric).

The load space cover can also be stored here (SW).

# Exterior lighting control stalk

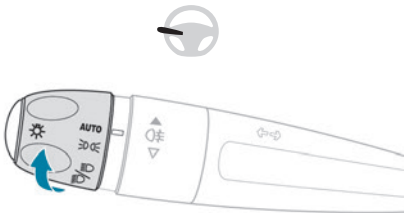
## Main lighting



- AUTO** Automatic illumination of lamps/daytime running lamps
-  Sidelamps only
-  Dipped or main beam headlamps

## Headlamp dipping

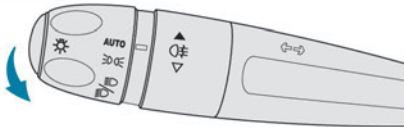

► Pull the lighting control stalk to switch between dipped and main beam headlamps.

In "AUTO" and sidelamps mode, pull the lighting control stalk to switch the main beam headlamps on directly ("headlamp flash").

## Display

Illumination of the corresponding indicator lamp on the instrument panel confirms that the selected lighting is on.

 A fault with a lamp is signalled by the permanent illumination of this warning lamp, accompanied by the display of a message and an audible signal.

## Rear foglamps

 They only work if the dipped or main beam headlamps are on.



► Rotate the ring forwards/backwards to turn them on/off.

When the lighting is switched off automatically ("AUTO" position) the foglamps and the dipped beam headlamps remain on.

**!** Switching on the foglamps is prohibited in clear weather or in rain, both day and night. In these situations, the power of their beams may dazzle other drivers. They must

only be used in fog or falling snow (rules may vary depending on country). Do not forget to switch off the foglamps when they are no longer necessary.

**i** **Switching off of the lighting when the ignition is switched off**  
When the ignition is switched off, all of the lamps turn off immediately, except for the dipped beam headlamps if automatic guide-me-home lighting is activated.

**i** **Switching on the lamps after switching off the ignition**  
To reactivate the lighting control, rotate the ring to the "AUTO" position, then to the desired position.  
If the driver's door is opened, a temporary audible signal warns the driver that the lamps are on.  
They will go off automatically after a period of time that depends on the level of charge in the battery (entering energy economy mode).

**i** In some weather conditions (e.g. low temperature or humidity), misting on the internal surface of the glass of the headlamps and rear lamps is normal, and will disappear after the lamps have been on for a few minutes.

**!** Never look too closely at the light beam of LED technology lamps - risk of serious eye injury!



### **i** Travelling abroad

Vehicles equipped with manual headlamp beam height adjustment: If planning to use your vehicle in a country that drives on the other side of the road, the dipped beam headlamps must be adjusted to avoid dazzling oncoming drivers. Consult a PEUGEOT dealer or a qualified workshop.

## Daytime running lamps/ Sidelamps

These LED lamps at the front of the vehicle light up automatically when the engine starts.

They perform the following functions:

- Daytime running lamps (lighting control stalk at position "AUTO" with adequate ambient light).
- Sidelamps (lighting control stalk at position "AUTO" with low ambient light or "Sidelamps only" or "Dipped/main beam headlamps").

**i** In daytime running lamps mode, the light-emitting diodes are brighter.

## Direction indicators

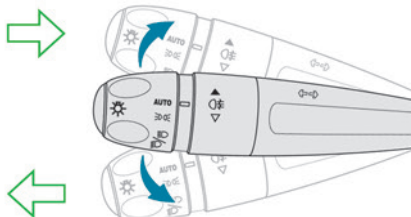

▶ Left or right: lower or raise the lighting control stalk, beyond the point of resistance.

**i** If you keep the direction indicators on for more than 20 seconds, the volume of the audible signal will increase if the speed is above 50 mph (80 km/h).

## Three flashes

▶ Press briefly upwards or downwards, without going beyond the point of resistance; the direction indicators will flash 3 times.

The brightness of the daytime running lamps is reduced when the direction indicators are on.

## Parking lamps

(Depending on version)

Vehicle side marking by lighting the sidelamps on the traffic side only.

▶ Within one minute after switching off the ignition, operate the lighting control stalk upwards or downwards, depending on the side of the traffic (e.g. when parking on the right, push the lighting control stalk down to light up on the left).

This is confirmed by an audible signal and the lighting of the corresponding direction indicator lamp on the instrument panel.

▶ To switch off the parking lamps, return the lighting control stalk to the central position.

## Headlamp beam height adjustment

### Manual headlamp adjustment

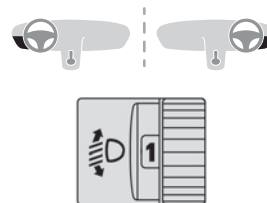

To avoid dazzling other road users, the height of the headlamp beams must be adjusted according to the load in the vehicle.



**0 (Initial setting)**

Driver only or driver + front passenger

**1** 5 people**2** 5 people + load in the boot**3** Driver only + load in the boot**4 5 6** Not used

## Automatic Peugeot Matrix LED Technology 2.0 headlamp adjustment

This system automatically adjusts the height of the headlamp beams according to different parameters (e.g. vehicle load).



In the event of a malfunction, this warning lamp lights up on the instrument panel, accompanied by the display of a message and an audible signal.

The system places the headlamp beams in the lowest position.

Have it checked by a PEUGEOT dealer or a qualified workshop.



Do not touch the Peugeot Matrix LED Technology 2.0 headlamps - risk of electrocution!

## Automatic illumination of lamps

With the lighting control stalk in the "AUTO" position and if a low level of exterior brightness

is detected by the rain/sunshine sensor, the sidelamps and dipped beam headlamps are switched on automatically, without any action on the part of the driver. They may also come on if rain is detected, at the same time as automatic operation of the windscreen wipers.

As soon as the brightness returns to a sufficient level or after the windscreen wipers are switched off, the lamps are switched off automatically.

## Malfunction



In the event of a malfunction of the rain/sunshine sensor, the vehicle's lamps come on and this warning lamp is displayed on the instrument panel, accompanied by an audible signal and/or the display of a message. Have it checked by a PEUGEOT dealer or a qualified workshop.



Do not cover the rain/sunshine sensor located at the top centre of the windscreen behind the interior rear view mirror; the associated functions would no longer be controlled.



In fog or snow, the rain/sunshine sensor may detect sufficient light. For this reason, the lighting will not come on automatically.



The inner surface of the windscreen may become misted up and affect the proper operation of the rain/sunshine sensor. In humid and cold weather, demist the windscreen regularly.

## Guide-me-home and welcome lighting

### Guide-me-home lighting

#### Automatic

With the ring of the lighting control stalk in the "AUTO" position and when the light is poor, the dipped beam headlamps come on automatically when the ignition is switched off.



You can activate/deactivate and adjust the duration of the guide-me-home lighting in the **Settings > Vehicle** touch screen application.

#### Manual

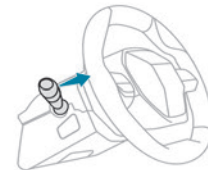

► With the ignition off, pull the lighting control stalk toward you ("headlamp flash") to activate/deactivate the function.

Manual guide-me-home lighting goes off automatically after a period of time.

## Welcome lighting

When the vehicle is unlocked in low light conditions and the "Automatic illumination of headlamps" function is activated, this system automatically switches on:

- On the outside, sidelamps, dipped beam headlamps and door mirror spotlamps.
- Inside, courtesy lamps and footwell lighting.

## Door mirror spotlamps

These spotlamps facilitate access to the vehicle by lighting the ground near the front doors.

The spotlamps come on automatically:

- when the vehicle is unlocked.
- when a door is opened.
- when a request to locate the vehicle is received from the remote control.

They also come on with the welcome lighting and guide-me-home lighting functions.

They go off automatically after 30 seconds.

## Automatic lighting systems - General recommendations

The automatic lighting systems use a detection camera, located at the top of the windscreen.

### Operating limits

The system may be disrupted or not work correctly:

- When visibility conditions are poor (e.g. snowfall, heavy rain).
- If the windscreen is dirty, misted-up or masked (e.g. sticker) in front of the camera.
- If the vehicle is facing highly reflective signs or safety barrier reflectors.

The system is not able to detect:

- Road users that do not have their own lighting, such as pedestrians.
- Vehicles with hidden lighting (e.g. travelling behind a safety barrier on the motorway).
- Vehicles at the top or bottom of a steep slope, on winding roads, on crossroads.

### Maintenance

Clean the windscreen regularly, particularly the area in front of the camera. The internal surface of the windscreen can also become misted around the camera. In humid and cold weather, demist the windscreen regularly.

Do not allow snow to accumulate on the bonnet or roof of the vehicle as this could obstruct the camera.

## Automatic headlamp dipping

 For more information, refer to the **General recommendations for automatic lighting systems.**

With the ring of the lighting control stalk in the "AUTO" position and the function activated on the touch screen, this system automatically switches between dipped and main beam headlamps, according to lighting and traffic conditions, using a camera located at the top of the windscreen.

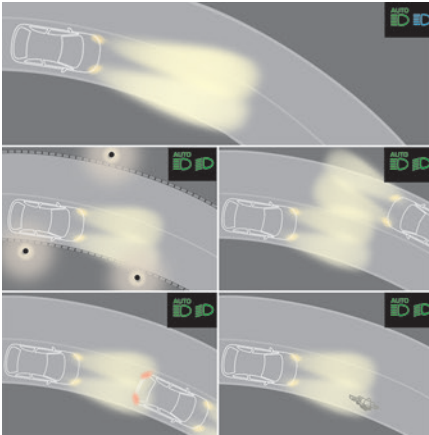



The state of the system is stored when the ignition is switched off.



**i** When the system detects thick fog, it temporarily deactivates the function.

## Operation

If the ambient light level is very low and traffic conditions permit:



  – The main beam headlamps come on automatically. These indicator lamps light up on the instrument panel.

If the ambient light level is sufficient and/or the traffic conditions do not allow the main beam headlamps to be lit:

  – The dipped beam headlamps remain lit. These indicator lamps light up on the instrument panel.

The function is deactivated if the foglamps are switched on or if the system detects poor visibility conditions (e.g. fog, heavy rain, snowfall).

When the foglamps are switched off or when the visibility conditions become favourable again, the function is automatically reactivated.

  This indicator lamp goes out when the function is deactivated.

## Pause



If the situation requires a change of headlamp beam, the driver can take over at any time.

► Switch the headlamps manually between dipped and main beam to pause the function. If the "AUTO" and "Dipped beam" indicator lamps were on, the system changes to main beam.

If the "AUTO" and "Main beam" indicator lamps were on, the system changes to dipped beam.

► To reactivate the function, once again switch the headlamps manually between dipped and main beam.

## Malfunction

  If a malfunction occurs with the system or the camera, this warning lamp lights up on the instrument panel, accompanied by an audible signal and a message. Have it checked by a PEUGEOT dealer or a qualified workshop.

## Peugeot Matrix LED Technology 2.0

**!** For more information, refer to the **General recommendations for automatic lighting systems.**

Available only on versions equipped with Full LED headlamps with Matrix Beam function. This system automatically adapts the main beam according to the driving conditions, so that optimum illumination is maintained for the driver, without causing a nuisance to other road users.

**!** This system is a driving aid. The driver remains responsible for the vehicle's lighting, its correct use in the prevailing light, visibility and traffic conditions, and for compliance with driving and vehicle regulations.

**i** The system becomes operational when the vehicle exceeds 16 mph (25 km/h). When the speed falls below 9 mph (15 km/h), the function is no longer operational.

## Activation/Deactivation



It is configured in the **Settings > Vehicle** touch screen application.

**!** The driver remains responsible for the vehicle's lighting, its correct use in the prevailing light, visibility and traffic conditions, and for compliance with driving and vehicle regulations.

**i** The system is active from 25 mph (40 km/h) and deactivates below 12 mph (20 km/h).

## Activation/Deactivation

► Place the ring of the lighting control stalk in the **"AUTO"** position.

**AUTO** This indicator lamp comes on in the instrument panel.

 It is configured in the **Settings > Vehicle** touch screen application.

The state of the system is stored when the ignition is switched off.

When deactivated, the lighting system changes to "Automatic illumination of lamps" mode.

**i** It is recommended that you deactivate the function in foggy or snowy conditions or in case of heavy mist.

The function temporarily is deactivated when the system detects thick fog or when the foglamps are switched on manually. This is signalled by the indicator lamp going off on the instrument panel.

## Operation

Using a camera, the system detects the driving conditions (brightness, lights from oncoming or followed vehicles, road turns) and adapts the beams of the main headlamps accordingly. The modules that make up the main beams switch on and off gradually, segment by segment, depending on the driving conditions detected.

Nominal main beam lighting is restored as soon as the vehicle is no longer detected by the system.

**AUTO**  If the system is selected but the display on the instrument panel and the alerts are not available, the indicator lamp comes on in grey.

### Followed vehicle

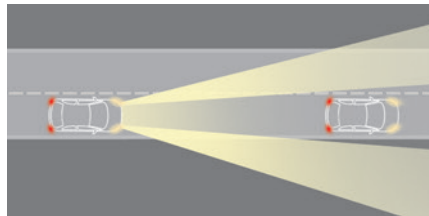

When approaching a vehicle from behind, only those lamp segments directed at the followed vehicle go off, thereby creating a "tunnel" so as not to dazzle its driver.

### Oncoming vehicle

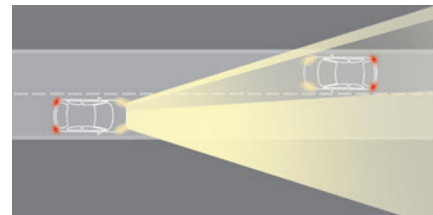

When an oncoming vehicle approaches, only those lamp segments directed at this vehicle go off, thereby creating a "tunnel" during the duration of the approach.

### Entering an illuminated area

At the entrance to an illuminated area (e.g. a town), the lamp segments are gradually switched off from the outside to the inside of the vehicle to switch to the dipped beams.

### Exiting an illuminated area

The lamp segments gradually light up from the inside to the outside of the vehicle to restore the main beams.

## Pause

If the situation requires a change of headlamp beam, the driver can take over at any time.

► Switch the dipped/main beam headlamps manually to pause the function.

The lighting system changes to "Automatic illumination of lamps" mode.

► To reactivate the function, manually switch the dipped/main beam headlamps again.

## Malfunction

**AUTO**  
**ED** In the first case, this warning lamp is displayed on the instrument panel, accompanied by a message if the sensor is masked.

This is a normal behavior, which does not request the support of a qualified workshop. Stop the vehicle and verify if the front camera is covered by dirt, mud, sand, snow, ice or anything preventing the sensing.

The system is operational again after the detection field has been cleaned.

**AUTO**  
**ED** In the second case, this warning lamp is displayed on the instrument panel, accompanied by an audible signal and a message if a malfunction occurs with the adaptive headlamp lighting or the camera. Have it checked by a PEUGEOT dealer or a qualified workshop.

**!** Do not cover the rain/sunshine sensor located at the top centre of the windscreen behind the interior rear view mirror; the associated functions would no longer be controlled.

## Wiper control stalk

**i** Before operating the wipers in wintry conditions, clear any snow, ice or frost from the windscreen and around the wiper arms and blades.

**!** Do not operate the wipers on a dry windscreen. In extremely hot or cold weather, check that the wiper blades are not stuck to the windscreen before operating the wipers.

**i** After using an automatic car wash, you may temporarily notice abnormal noises and poorer wiping performance. You do not need to replace the wiper blades.

## With intermittent wipers

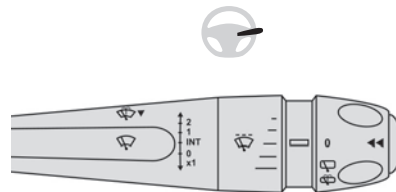

## With AUTO wiping

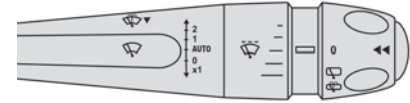

## Windscreen wipers

► To select the wiping speed: raise or lower the stalk to the desired position.

**2** Fast wiping (heavy rain)

**1** Normal wiping (moderate rain)

**Int** Intermittent wipers

or

**AUTO** Automatic wipers

**0** Switching off

**x1** Manual

**i** After the ignition has been switched off, the wipers may move slightly at the foot of the windscreen.

**I** In position **1** or **2**, the wiping frequency is automatically reduced when the speed of the vehicle drops below 3 mph (5 km/h). When the speed is above 6 mph (10 km/h) again, the wiping frequency returns to the original frequency (fast or normal).

### Single wipe

If the wiper control stalk is:

- ▶ In the **INT** or **AUTO** position, pull the stalk briefly towards you then release it.
- ▶ In the **0** position, press briefly on the stalk then release it.

Pressing and holding triggers continuous wiping at the normal wiping speed.

### Windscreen wash

- ▶ Pull the wiper control stalk towards you and hold.

A final wiping cycle is performed when screenwashing ends.

**I** The windscreen wash jets are incorporated into the tip of each wiper arm.

An additional jet is installed below the midpoint of the arm on the driver's side. Screenwash fluid is sprayed along the length of the wiper blade. This improves visibility and reduces screenwash fluid consumption.



**I** With automatic air conditioning, any action on the screenwash control results in temporary closure of the air intake to protect the passenger compartment from any odour.

**!** To avoid damaging the wiper blades, do not operate the screenwash if the screenwash reservoir is empty. Only operate the screenwash if there is no risk of the fluid freezing on the windscreen and hindering visibility. During the winter period, use "very cold climate" rated products. Never top up with water.

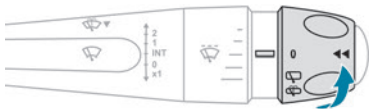
### Rear wiper



- ▶ Turn the ring to align the desired symbol with the marking.

-  Off
-  Intermittent wiping
-  Screenwash-wipe

**I** If the ignition has been switched off with the rear wiper active, operate the ring to

reactivate wiping when the ignition is switched on again (unless the ignition was off for less than 1 minute).

The first rotation of the ring to the screenwash position triggers a single wipe. If the ring is then left in the intermittent wiping position, the rear wiper adopts a wiping speed dependent on that of the windscreen wipers and the speed of the vehicle.

### Reverse

When reverse gear is engaged, the rear wiper will come into operation automatically if the front windscreen wipers are operating.



It is configured in the **Settings > Vehicle** touch screen application.

**!** In the event of accumulation of snow or hard frost or if a bicycle carrier is fitted to a towing system, deactivate the automatic rear wiper via the **Settings > Vehicle** touch screen application.

### Rear screenwash

- ▶ Turn the ring as far as it will go and hold it in position.

The screenwash and the wiper operate for as long as the ring remains turned. A final wiping cycle is performed when screen washing ends.

An additional jet is fitted above the number plate to clean the reversing camera (depending on version).



With reverse gear engaged, the washing of the reversing camera is triggered by clicking on this button in the right side menu of the touch screen.

## Front intermittent wiping

In Intermittent mode, the driver can adjust the wiping frequency by turning the ring to one of the 5 available positions.

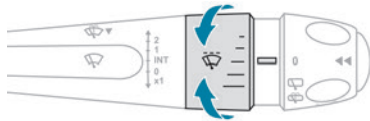

The first (upper) position corresponds to the longest time interval between 2 wipes for light rain.

The last (lower) position corresponds to the shortest time interval between 2 wipes for heavy rain.

A rotation of the ring from a higher position to a lower position triggers a confirmation wiping.

- i** After the ignition has been switched off for more than 1 minute with the wiper control stalk in the **INT**, **1** or **2** position, when the ignition is switched on again:
  - the system works as soon as the vehicle exceeds 6 mph (10 km/h), if the outside temperature is below +3°C.

- the system works immediately, if the outside temperature is above +3°C.

## Automatic windscreen wipers

In **AUTO** mode, the front wipers work automatically and adapt to the intensity of precipitation depending on the sensitivity of the sensor selected.

The rainfall detection function uses a rain/sunshine sensor located at the top centre of the windscreen, behind the rear view mirror.

- i** In certain weather conditions (e.g. fog, frost, snow, projections on salty roads), the driver may have to return to manual wiping.

## Switching on/off

To switch on:

- ▶ Put the wiper control stalk in the **AUTO** position.
- ▶ Turn the ring to adjust the sensitivity of the sensor.

A wiping cycle, accompanied by the display of a message, confirms that the request has been taken into account.

- ▶ To switch off, put the wiper control stalk in another position or in the **0** position.

## Adjusting the sensitivity

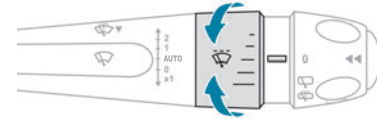

The first position (upper) corresponds to the lowest sensitivity of the sensor.

The last position (lower) corresponds to the highest sensitivity of the sensor.

The higher the sensitivity, the faster the system reacts and increases the wiping frequency.

A rotation of the ring from a higher position to a lower position triggers a confirmation wiping.

- i** After the ignition has been switched off for more than 1 minute with the wiper control stalk in the **AUTO** position, when the ignition is switched on again:

- the system works, depending on the volume of rain detected, as soon as the vehicle exceeds 6 mph (10 km/h), if the outside temperature is below +3°C.
- the system works immediately, depending on the volume of rain detected, if the outside temperature is above +3°C.

- !** Do not cover the rain/sunshine sensor. When using an automatic car wash, switch off the automatic wipers and the ignition.

In winter, wait until the windscreen is completely clear of ice before activating the automatic wipers.

## Malfunction

If a fault occurs with the automatic wipers, the wipers operate in intermittent mode. Have it checked by a PEUGEOT dealer or a qualified workshop.

## Special position of the windscreen wipers

This maintenance position is used while cleaning or replacing the wiper blades. It can also be useful, in wintry weather (ice, snow), to release the wiper blades from the windscreen.

**i** To maintain the effectiveness of the flat wiper blades, it is advisable to:

- handle them with care.
- clean them regularly using soapy water.
- avoid using them to hold cardboard on the windscreen.
- replace them at the first signs of wear.

## Before removing a windscreen wiper blade

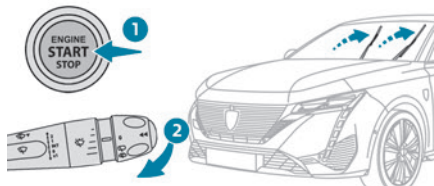

Operating the wiper control stalk immediately after switching off the ignition will place the wiper blades in a vertical position.

► Proceed with the desired operation or the replacement of the wiper blades.

## After refitting a windscreen wiper blade

► To return the wiper blades to their initial position after the operation, switch on the ignition and operate the wiper control stalk.

## Changing a wiper blade

### Removing/Refitting at the front

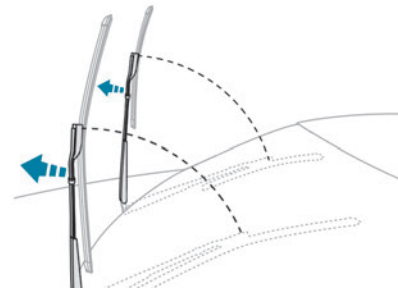

► Carry out these wiper blade replacement operations from the driver's side.

► Starting with the wiper blade farthest from you, hold each arm by the rigid section and raise it as far as possible.

**!** Take care not to hold the arms at the jet locations.

Do not touch the wiper blades - risk of irreparable deformation.

Do not release them while moving them. Risk of damaging the windscreen!

► Clean the windscreen using screenwash fluid.

**i** Do not apply "Rain X" type water-repellent products.



- ▶ Unclip the worn wiper blade closest to you and remove it.
- ▶ Install the new wiper blade and clip it to the arm.
- ▶ Repeat the procedure for the other wiper blade.
- ▶ Starting with the wiper blade closest to you, once again hold each arm by the rigid section, then guide it carefully onto the windscreen.

**!** Take care not to use an incorrect position during fitting - risk of damage!

### Removing/refitting at the rear

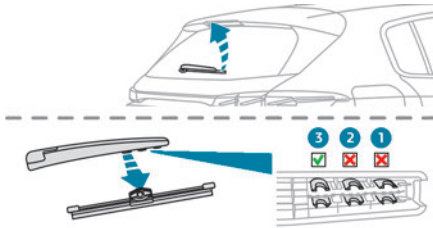

- ▶ Hold the arm by the rigid section and raise it as far as possible.
- ▶ Clean the rear screen using screenwash fluid.
- ▶ Identify the position of the arm on which the wiper blade is attached.
- ▶ Unclip the worn wiper blade by pulling it towards the rear screen and remove it.
- ▶ Install the new wiper blade in the same position of the arm and clip it into position.
- ▶ Once again hold the arm by the rigid section, then guide it carefully onto the rear screen.

## General safety recommendations

**!** Do not remove the labels attached in different places on your vehicle. They include safety warnings as well as identification information for the vehicle.

**!** Depending on country regulations, certain safety equipment may be mandatory: high visibility safety vests, warning triangles, breathalysers, spare bulbs, spare fuses, fire extinguisher, first aid kit, mud flaps at the rear of the vehicle, etc.

**!** **Installing electrical accessories**  
The fitting of electrical equipment or accessories not approved by PEUGEOT may cause excessive current consumption and faults and failures with the electrical system of your vehicle. Contact a PEUGEOT dealer

for information on the range of approved accessories.

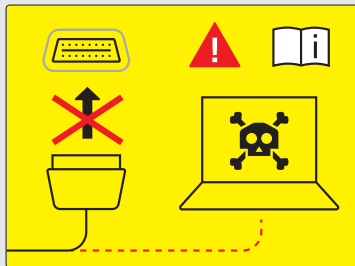

As a safety measure, access to the **diagnostic socket**, used for the vehicle's electronic systems, is reserved strictly for PEUGEOT dealers or qualified workshops, equipped with the special tools required (risk of malfunctions of the vehicle's electronic systems that could cause breakdowns or serious accidents). The Manufacturer cannot be held responsible if this advice is not followed.

Any modification or adaptation not intended or authorised by PEUGEOT or carried out without meeting the technical requirements defined by the Manufacturer will result in the suspension of the commercial warranty.

**!** **Installation of accessory radio communication transmitters**

Before installing a radio communication transmitter with an external aerial, you must

without fail contact a PEUGEOT dealer for the specification of transmitters which can be fitted (frequency, maximum power, aerial position, specific installation requirements), in line with the UN ECE Regulation 10.

**i** **Declarations of conformity for radio equipment**

The relevant certificates are available on the brand website:

<http://public.servicebox.peugeot.com/APddb/>

## Hazard warning lamps

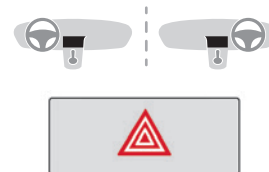

► Pressing this button causes all the direction indicators to flash.

They can work with the ignition switched off.

## Automatic operation of hazard warning lamps

When braking in an emergency, depending on the rate of deceleration, the hazard warning lamps come on automatically. They switch off automatically when you next accelerate.

They can be switched off by pressing the button.

## Horn

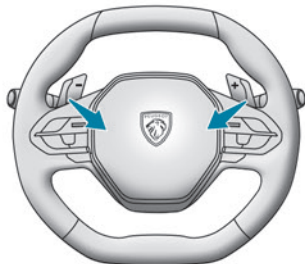

► Press the central part of the steering wheel.

## Pedestrian horn (Hybrid, Rechargeable hybrid or Electric)

This system alerts pedestrians that the vehicle is approaching (Electric), when driving in all-electric (Hybrid) or in **Electric** driving mode (Rechargeable hybrid).

The pedestrian horn operates once the vehicle is moving and at speeds of up to 19 mph (30 km/h), in forward or reverse gear.

This function cannot be deactivated.

## Emergency or assistance call

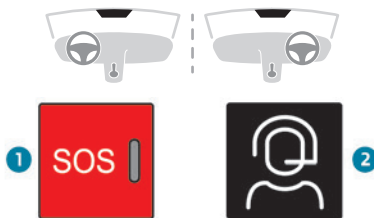

1. eCall (SOS)
2. ASSISTANCE

## eCall (SOS)

Your vehicle may be fitted with the eCall (SOS) system either as standard or as an option. The eCall (SOS) system provides direct contact to the emergency services and is fully built into the vehicle. This contact is made either automatically via the sensors built into the vehicle, or by pressing button **1**.

According to the country of sale, the eCall (SOS) system corresponds to the systems PE112, ERAGLONASS, 999, etc.

The eCall (SOS) system is activated by default.

► To make an emergency call manually, press button **1** for more than 2 seconds.

The lit indicator lamp and a voice message confirm that the call has been made to the emergency services\*.

The eCall (SOS) system immediately locates your vehicle and puts you in contact with the appropriate emergency services\*\*.

► Pressing again immediately cancels the request.

The indicator lamp flashes while the vehicle data is being sent, and then remains lit when communication is established.

**!** In the event that a serious accident is detected by the sensors built into the vehicle, such as the airbag control unit, an emergency call is made automatically.

**i** The eCall (SOS) system is a public service of general interest and is free-of-charge.

## Operation of the system

– Upon switching on the ignition, the indicator lamp lights up for a few seconds and then goes out: the system is operating correctly.

\* In accordance with the general conditions of use of the service, available from dealers and subject to technological and technical limitations.

\*\* Depending on the geographic coverage provided by the "eCall (SOS)" and "ASSISTANCE" systems.

The list of countries covered and the telematic services provided is available from dealers or on the website for your country.

- The indicator lamp flashes red: emergency battery is flat. This will be recharged after a few minutes' driving.
  - The indicator lamp is fixed red: system malfunction. The emergency and assistance call services may not work.
  - If the indicator lamp does not light up when the ignition is turned on, this is also a system malfunction.
- If the problem persists, contact a qualified workshop as soon as possible.

**i** The malfunction of the system does not prevent the vehicle from driving.

**i** When an onboard system update is being performed, the eCall (SOS) function is not available.

### **i** Data processing

All processing of personal data by the eCall (SOS) function complies with the framework for protection of personal information established by Regulation 2016/679 (General Data Protection Regulation - GDPR) or by UK GDPR (Data Protection, Privacy and Electronic Communications) Regulations 2019 and Directive 2002/58/EC of the European Parliament and the Council, and in particular, seeks to protect the vital interests of the data

subject, in accordance with Article 6 (1) d) GDPR.

The processing of personal data is strictly limited to the purpose of handling the eCall (SOS) function used with the "112" single European emergency call number. The eCall (SOS) function is only able to collect and process the following data relating to the vehicle: vehicle identification number, vehicle type (passenger vehicle or light commercial vehicle), fuel type or power source, three most recent locations and direction of travel, number of passengers and a timestamped log file of the automatic activation of the system and its timestamp. The recipients of the processed data are the emergency call handling centres designated by the relevant national authorities in the territory in which they are located, enabling priority routing and handling of calls to the "112" emergency number.

### **i** Data storage

Data contained in the system's memory is not accessible from outside the system until a call is made. The system is not traceable and is not continuously monitored in its normal operating mode. The data in the system's internal memory is automatically and continuously erased. Only the vehicle's three most recent locations,

necessary for the normal functioning of the system, are stored. When an emergency call is triggered, the data log is stored for no more than 13 hours.

### **i** Access to data

You have the right of access to data and as appropriate to request the rectification, erasure or restriction of processing of any personal data not processed in accordance with the provisions of GDPR. Third parties to which data has been disclosed shall be notified of any rectification, erasure or restriction carried out in compliance with the corresponding GDPR, unless it proves impossible or involves a disproportionate effort.

You also have the right to lodge a complaint with the respective data protection supervisory authority. If you want to claim your above-mentioned rights please contact us per email at: [privacyrights@stellantis.com](mailto:privacyrights@stellantis.com). For more information regarding our contact details please take a look at our Privacy & Cookies Policy on the brand's website.

## ASSISTANCE

- ▶ If the vehicle breaks down, press button **2** for more than 2 seconds to request assistance (confirmed by a voice message\*).
- ▶ Pressing again immediately cancels the request.

**i** Privacy mode allows you to manage the level of sharing (data and/or location) between your vehicle and PEUGEOT. It can be configured in the **Settings** touch screen application.

**i** If you purchased your vehicle outside the PEUGEOT dealer network, you are invited to have a dealer check the configuration of these services and, if desired, modify it as required. In a multilingual country, services can be configured to use the official national language of your choice.

**i** For technical reasons and in particular to improve the quality of telematics services provided to customers, the Manufacturer reserves the right to carry out updates to the vehicle's on-board telematics system at any time.

**!** During an update to the vehicle's on-board telematics system, the ASSISTANCE system will be unavailable.

**i** If you benefit from the Peugeot Connect Packs offer with the SOS and Assistance Pack included, there are additional services available to you in your personal space, via the website for your country. For information about the SOS and Assistance Pack, please refer to the general conditions for these services.

## Event Data Recording system

(Depending on country of sale)

This vehicle is fitted with an accident data recording system, also called Event Data Recorder (EDR).

This system gathers and records certain vehicle data over a short period (a few seconds) before, during and after an event such as an accident or collision.

In order to gain a better understanding of the circumstances surrounding the event, this system records how the vehicle's various

systems are operating at the time of the event, including:

- Any deployment of a restraint system (e.g. airbag, seat belt).
- The status of the seat belts of all the occupants (fastened/unfastened).
- The contact or intensity of pressure exerted on the pedal(s) engaged by the driver.
- The speed of the vehicle.
- The status of some driving and manoeuvring aids systems.

The following are not recorded by the system:

- Data on normal driving conditions, in other words data not directly related to the event.
- Personal data on the driver and any other occupants.
- The geographical location of the vehicle at the time of the event.

The reading of data recorded by the system requires the following:

- Access to the interior of the vehicle or to the system.

And

- Special equipment that can be purchased from the manufacturer BOSCH ([www.BoschCDRTool.com](http://www.BoschCDRTool.com)).

Aside from the vehicle Manufacturer, other parties such as law enforcement agencies may access this data in order to analyse the event.

\* Depending on the geographic coverage of the "eCall (SOS)" and "ASSISTANCE" systems and the official national language chosen by the owner of the vehicle.

The list of countries covered and the telematic services provided is available from dealers or on the website for your country.

## Electronic stability control (ESC)

The electronic stability control programme includes the following systems:

- Anti-lock braking system (ABS) and Electronic brake force distribution (EBFD).
- Emergency braking assistance (EBA).
- Post Collision Safety Brake (PCSB).
- Anti-slip regulation (ASR).
- Dynamic stability control (DSC).
- Trailer stability assist (TSA).

## Anti-lock braking system (ABS)/Electronic brake force distribution (EBFD)

These systems enhance the vehicle's stability and handling during braking, and enable greater control while cornering, particularly on poor or slippery road surfaces.

ABS prevents wheel locking in the event of emergency braking.

Electronic brake force distribution (EBFD) manages overall braking pressure on each individual wheel.

► **When braking in an emergency, depress the pedal very firmly and maintain this pressure.**

**i** Normal operation of the ABS may make itself felt by slight vibrations of the brake pedal.



The fixed illumination of this warning lamp signals that there is a fault with the ABS.

The vehicle retains conventional braking. Drive carefully at a moderate speed.

Have it checked by a PEUGEOT dealer or a qualified workshop.



This warning lamp, when lit together with the **STOP** and ABS warning lamps, accompanied by a message and an audible signal, indicates an EBFD malfunction.

**You must stop the vehicle.**

Stop as soon as it is safe to do so and switch off the ignition.

Contact a PEUGEOT dealer or a qualified workshop.



When changing wheels (tyres and rims), ensure that these are approved for your vehicle.



**After an impact**  
Have it checked by a PEUGEOT dealer or a qualified workshop.

## Emergency braking assistance (EBA)

This system reduces the emergency stopping distance, by optimising the braking pressure. It is triggered in relation to the speed at which the brake pedal is depressed. The effect of this is a reduction in the resistance of the pedal and an increase in braking efficiency.

## Post Collision Safety Brake (PCSB)

If an accident is detected, the vehicle initiates automatic post collision braking. The goal of this system is to reduce the risk of further collisions if the driver does not react.

The system is not operational if the capability of the vehicle to trigger and execute the automatic post collision braking is not available, as it can occur in destructive accidents or in other specific accident scenarios.

It is possible to override the automatic braking by pressing the brake pedal or accelerator pedal.

### Operating conditions

The system operates, if the following conditions are met:

- Airbags or pyrotechnic seat belt pretensioners have been deployed by the collision.
- Braking systems and electric functions remain continuously operational during and after collision.
- Driver has not depressed the brake or accelerator pedal.

### Malfunction



In the event of a malfunction, one of these warning lamps will come on fixed on the instrument panel, accompanied by the Service warning lamp, the display of a message and an audible signal.

Have it checked by a PEUGEOT dealer or a qualified workshop.

## Anti-slip regulation (ASR)/ Dynamic stability control (DSC)

Anti-slip regulation (or traction control) optimises traction by using engine braking and by applying the brakes on the driving wheels to avoid one or more wheels spinning. It also enhances the vehicle's directional stability.

If there is a difference between the vehicle's trajectory and the path desired by the driver, the dynamic stability control system automatically uses engine braking and the brakes on one or more wheels to return the vehicle to the desired path, within the limits of the laws of physics.

These systems are activated automatically every time the vehicle is started.



These systems are activated in the event of a problem with grip or trajectory (confirmed by this warning lamp flashing on the instrument panel).

### Deactivation/Reactivation

In exceptional conditions (e.g. moving a vehicle that is bogged down in mud, stuck in snow, on loose soil), it may prove useful to deactivate the DSC/ASR systems, so that the wheels can move freely and regain grip.

Reactivate the system as soon as the level of grip permits.



The ASR system is deactivated/reactivated in the **ADAS** touch screen application.



Deactivation/reactivation of the ASR system is indicated by this indicator lamp on the instrument panel coming on/going out and the display of a message.

The ASR system is automatically reactivated every time the ignition is switched off or at speeds over 31 mph (50 km/h)  
Reactivation is manual below 31 mph (50 km/h).

### Malfunction



In the event of a malfunction, this warning lamp lights up on the instrument panel, accompanied by the display of a message and an audible signal.

Have it checked by a PEUGEOT dealer or a qualified workshop.



### ASR/DSC

These systems enhance safety during normal driving, but should not encourage the driver to take extra risks or drive at high speed.

It is in conditions of reduced grip (rain, snow, ice) that the risk of loss of grip increases. It is therefore important for your safety to keep these systems activated in all conditions, and particularly in difficult conditions.

Correct operation of these systems depends on compliance with the manufacturer's recommendations relating to the wheels

(tyres and rims), braking and electronic components, as well as the assembly and repair procedures provided by PEUGEOT dealers.

In order to ensure that these systems remain effective in wintry conditions, the use of snow or all-season tyres is recommended. All four wheels must be fitted with tyres approved for your vehicle.

All tyre specifications are listed on the tyre/paint label. For more information on **Identification markings**, refer to the corresponding section.

## Trailer stability assist (TSA)

When towing, this system reduces the risk of the vehicle or trailer snaking.

### Operation

The system is activated automatically when the ignition is switched on.

The electronic stability control system (ESC) must not have any faults.

The vehicle speed must be between 37 and 99 mph (60 and 160 km/h).



If the system detects that the trailer is snaking, it applies the brakes to stabilise the trailer and reduces engine power, if necessary, to slow the vehicle (indicated by the flashing of this warning lamp on the instrument panel and the brake lamps coming on).

For more information on weights and towed loads, refer to the **Engine technical data** and **towed loads** section or your vehicle's registration certificate.

To ensure safe driving with a **Towing device**, refer to the corresponding section.

## Malfunction



If a fault occurs, this warning lamp lights up on the instrument panel, accompanied by a message and an audible signal.

To continue towing a trailer, reduce speed and drive carefully!

Have it checked by a PEUGEOT dealer or a qualified workshop.



The trailer stability control system provides an extra safety feature under normal driving conditions, when following the recommendations for use of trailers and current legislation in force in your country. It must not encourage the driver to take extra risks, such as using a trailer in unsuitable conditions of operation (e.g. excessive load, exceeded nose weight, worn or under-inflated tyres, faulty braking system) or driving at excessive speed.

In certain cases, the system may not detect trailer snaking, particularly with a light trailer. When driving on slippery or poor surfaces, the system may not be able to prevent sudden trailer snaking.

## Seat belts

### Inertia reel

The seat belts are equipped with an inertia reel which allows the strap length to adjust automatically to the shape of the user. The seat belt returns to its storage automatically when it is not used.

The inertia reels are fitted with a device which automatically locks the strap in the event of a collision, emergency braking or if the vehicle rolls over. It can be released by pulling the strap firmly and then releasing it so that it reels in slightly.

### Pyrotechnic pretensioning

This system improves safety in the event of a frontal or side impact.

Depending on the severity of the impact, the pyrotechnic pretensioning system instantly tightens the seat belts against the body of the occupants.

The pyrotechnic pretensioning seat belts are enabled when the ignition is on.

### Progressive force limiting system

This system reduces the pressure of the seat belt on the chest of the occupant, taking their stature into account, thus improving their protection.



### In the event of an impact

Depending on the nature and seriousness of the impacts, the pyrotechnic device may trigger before and independently of airbag deployment. Deployment of the pretensioners is accompanied by a slight

discharge of harmless smoke and a noise, due to the activation of the pyrotechnic cartridge incorporated in the system. In all cases, the airbag warning lamp comes on.

Following an impact, have the seat belt system checked, and if necessary replaced, by a PEUGEOT dealer or a qualified workshop.

## Front seat belts

The front seat belts are fitted with a pyrotechnic pretensioning system and a progressive force limiting system.

## Rear seat belts

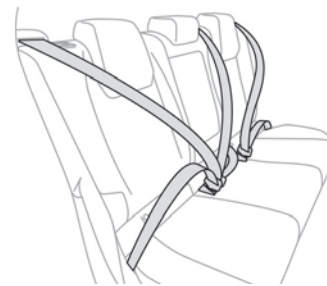

Each of the rear seats has a three-point seat belt with inertia reel.

The outer seats are fitted with a pyrotechnic pretensioning and force limiting system.



## Fastening

- ▶ Pull the strap, then insert the tongue into the buckle.
- ▶ Check that the seat belt is fastened correctly by pulling on the strap.

## Unfastening

- ▶ Press the red button on the buckle.
- ▶ Guide the seat belt as it is reeled in.

## Seat belt not fastened/unfastened alerts



1. Front left seat belt warning lamp
2. Front right seat belt warning lamp
3. Rear left seat belt warning lamp
4. Rear centre seat belt warning lamp
5. Rear right seat belt warning lamp

### Not fastened/unfastened warning lamp

It comes on in red on both the instrument panel and on the seat belts warning lamps display as soon as the system detects that a seat belt is not fastened or has been unfastened.



### Front seat belt not fastened alert

When the ignition is switched on, if the driver or front passenger has not fastened their seat belt, the corresponding warning lamp (1 or 2) comes on in red. At a speed greater than 12 mph (20 km/h), the warning lamp flashes red, accompanied by an audible signal for around 2 minutes. After this time has elapsed, the warning lamp remains on fixed in red until the seat belt is fastened.



### Rear seat belt not fastened alert

When the ignition is switched on, if one of the rear passengers has not fastened their seat belt, the corresponding warning lamp (3, 4 or 5) comes on in red for 1 minute.



### Seat belt unfastened alert

After the ignition is switched on, if the driver or a passenger unfastens their seat belt, the corresponding warning lamp (1, 2, 3, 4 or 5) comes on in red. At a speed greater than 12 mph (20 km/h), the warning lamp flashes, accompanied by an audible signal for around 2 minutes. After this time has elapsed, the warning lamp remains on until the seat belt has been fastened again.



With the ignition on, if the driver or a passenger fastens their seat belt, the corresponding warning lamp (1, 2, 3, 4 or 5) comes on in green on the display.



With the ignition on, if one of the front or rear passenger seats is detected as being unoccupied, the corresponding warning lamp (2, 3, 4 or 5) comes on in grey on the display.

When there are no longer any not fastened/unfastened alerts, the green or grey warning lamps remain on for around 30 seconds, then go off.

## Advice



The driver must ensure that passengers use the seat belts correctly and that they are all fastened before setting off.

Wherever seated in the vehicle, you must always fasten the seat belt, even for short journeys.

Do not invert the seat belt buckles, as they will not fulfil their role properly.

To ensure the proper functioning of the belt buckles, make sure that there are no foreign bodies present (e.g. a coin) before fastening. Before and after use, ensure that the seat belt is reeled in correctly.

After folding or moving a seat or rear bench seat, ensure that the seat belt is positioned and reeled in correctly.



### Installation

The lower part of the strap must be positioned as low as possible over the pelvis. The upper part must be positioned in the hollow of the shoulder.

At the front, adjusting the position of the seat belt may require the seat height to be adjusted.

In order to be effective, a seat belt must:

- be tightened as close to the body as possible.
- be pulled in front of you with a smooth movement, checking that it is not twisted.
- only be used to secure one person.
- not show signs of tearing or fraying.
- not be changed or modified, in order to avoid affecting its performance.

### **! Recommendations for children**

Use a suitable child seat if the passenger is less than 12 years old or shorter than 1.5 metres.

Never use the same seat belt to secure more than one child.

Never carry a child on your lap.

For more information on **Child seats**, refer to the corresponding section.

### **! Maintenance**

In accordance with current safety regulations, for all work on your vehicle's seat belts, contact a qualified workshop with the skills and equipment needed, which a PEUGEOT dealer is able to provide.

Have the seat belts checked regularly by a PEUGEOT dealer or a qualified workshop, particularly if the straps show signs of damage.

Clean the seat belt straps with soapy water or a textile cleaning product, sold by PEUGEOT dealers.

## Airbags

### General information

This system is designed to improve the safety of the occupants of the front seats and the rear outer seats in the event of a violent collision. The airbags supplement the action of the seat belts equipped with a force limiting system.

Electronic detectors record and analyse the front and side impacts sustained in the impact detection zones:

- In the event of violent impact, the airbags deploy instantly and help better protect the occupants of the vehicle; immediately after the impact, the airbags deflate rapidly in order not to hinder the visibility or the possible exit of the occupants.

- In the event of a slight impact, a rear impact and under certain rollover conditions, the airbags may not deploy; only the seat belt helps to protect you in these situations.

The seriousness of the impact depends on the nature of the obstacle and the speed of the vehicle at the moment of collision.

### **! The airbags do not operate when the ignition is switched off.**

This equipment will only deploy once. If a second impact occurs (during the same or a subsequent accident), the airbag will not be deployed again.

### Impact detection zones

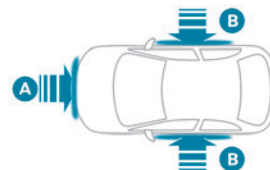

**A.** Front impact zone

**B.** Side impact zone

**i** When one or more airbags are deployed, the detonation of the pyrotechnic charge incorporated in the system makes a noise and releases a small quantity of smoke. This smoke is not harmful, but sensitive individuals may experience irritation. The detonation noise associated with the deployment of one or more airbags may result in a slight loss of hearing for a short time.

## Front airbags

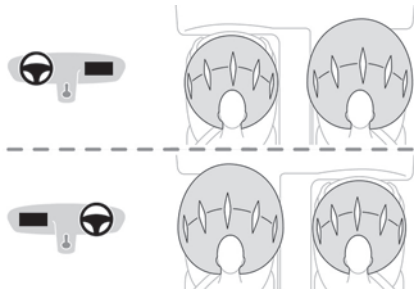

This system protects the driver and front passenger in the event of a serious front impact, limiting the risk of head and chest injury.

The driver's airbag is fitted in the centre of the steering wheel; the front passenger airbag is fitted in the dashboard above the glove box.

### Deployment

They are deployed, except for the front passenger airbag if it is deactivated\*, in the event of a violent front impact applied to all or part of front impact zone **A**.

The front airbag inflates between the chest and head of the front occupant of the vehicle and the steering wheel, on the driver's side, and the dashboard, on the passenger's side, to cushion their forward movement.

## Lateral airbags



This system protects the driver and front passenger in the event of a serious side impact, limiting the risk of injury to the chest, between the hip and the shoulder.

Each lateral airbag is fitted in the seat backrest frame, on the door side.

### Deployment

The lateral airbags are deployed on one side in the event of a serious side impact applied to all or part of the side impact zone **B**.

The lateral airbag inflates between the chest of the vehicle's occupant and the corresponding door panel.

## Curtain airbags

This system helps provide greater protection for the driver and passengers (with the exception of the rear centre passenger) in the event of a serious side impact, in order to limit the risk of injury to the side of the head.

Each curtain airbag is built into the pillars and the upper passenger compartment area.

### Deployment

It deploys simultaneously with the corresponding lateral airbag in the event of a serious side impact applied to all or part of the side impact zone **B**.

The curtain airbag inflates between the front and rear occupants of the vehicle and the corresponding windows.

### Malfunction



In the event of a malfunction, these warning lamps light up on the instrument panel. Contact a PEUGEOT dealer or a qualified workshop to have the system checked.

The airbags may not be deployed in the event of a serious impact.

\* For more information on Deactivating the front passenger airbag, refer to the corresponding section.

**!** In the event of a minor impact or bump at the side of the vehicle or if the vehicle rolls over, the airbags may not be deployed. In the event of a rear or front collision, none of the lateral airbags are deployed.

## Advice

**!** **For the airbags to be fully effective, observe the safety recommendations below.**

Adopt a normal and upright sitting position. Fasten your seat belt and position it correctly. Do not place anything between the occupants and the airbags (e.g. child, animal, object), do not fix or attach anything near or in the path of the airbags, as this could cause injuries when they are deployed.

Never modify the original definition of the vehicle, particularly in the area directly around the airbags.

Even if all of the precautions mentioned are observed, a risk of injury or of minor burns to the head, chest or arms cannot be ruled out when an airbag is deployed. The bag inflates almost instantly (within a few milliseconds) then deflates within the same time, discharging the hot gas via openings provided for this purpose.

After an accident or if the vehicle has been stolen, have the airbag systems checked. All work must be carried out only by a PEUGEOT dealer or a qualified workshop

**!** **Front airbags**  
Do not drive holding the steering wheel by its spokes or resting your hands on the centre part of the wheel. Passengers must not place their feet on the dashboard. Do not smoke as deployment of the airbags can cause burns or the risk of injury from a cigarette or pipe. Never remove or pierce the steering wheel or hit it violently. Do not fix or attach anything to the steering wheel or dashboard, as this could cause injuries when the airbags are deployed.

**!** **Lateral airbags**  
Use only approved seat covers compatible with the deployment of these airbags. For information on the range of seat covers suitable for your vehicle, contact a PEUGEOT dealer. Do not fix or attach anything to the seat backrests (e.g. clothing) as this could cause injuries to the chest or arm when the airbag is deployed. Do not sit with the upper part of the body any nearer to the door than necessary. The vehicle's front door panels include side impact sensors. A damaged door or any unauthorised or incorrectly executed work (modification or repair) on the front doors or their interior trim could compromise the operation of these

sensors - risk of malfunction of the lateral airbags!  
All work must be carried out only by a PEUGEOT dealer or a qualified workshop

**!** **Curtain airbags**  
Do not fix or attach anything to the roof, as this could cause head injuries when the curtain airbag is deployed. Do not remove the grab handles installed on the roof.

## Child seats

**i** The regulations on carrying children are specific to each country. Refer to the legislation in force in your country.

For maximum safety, please observe the following recommendations:

- In accordance with European regulations, **all children under the age of 12 or less than 1.5 metres tall must travel in approved child seats suited to their size or weight**, on seats fitted with a seat belt or ISOFIX mountings.
- **Statistically, the safest seats in your vehicle for carrying children are the rear seats.**
- **Children ageing less than 15 months must travel in the "rearward facing" position, whether in the front or rear of the vehicle.**

**i** It is **recommended** that children travel on the **rear seats** of the vehicle:

- "rearward facing" up to the age of 3.
- "forward facing" over the age of 3.

**!** Make sure that the seat belt is correctly positioned and tightened.

For child seats with a support leg, ensure that the support leg is in firm and steady contact with the floor.

**!** An incorrectly installed child seat in a vehicle compromises the child's safety in the event of an accident.

Ensure that there is no seat belt or seat belt buckle under the child seat, as this could destabilise it.

Remember to fasten the seat belts or the child seat harness keeping the slack relative to the child's body to a minimum, even for short journeys.

When installing a child seat using the seat belt, ensure that the seat belt is tightened correctly on the child seat and that it secures the child seat firmly on the vehicle seat. If the passenger seat is adjustable, move it forwards if necessary.

**Remove the head restraint before installing a child seat with a backrest on a passenger seat.**

Ensure that the head restraint is stored or attached securely to prevent it from being

thrown around the vehicle in the event of sharp braking. Refit the head restraint once the child seat has been removed.

### **!** Installing a booster seat

The chest part of the seat belt must be positioned on the child's shoulder without touching the neck.

Ensure that the lap part of the seat belt passes correctly over the child's thighs.

Use a booster seat with a backrest, equipped with a belt guide at shoulder level.

### **!** Additional protections

To prevent accidental opening of the doors and rear windows, use the "Child lock". Take care not to open the rear windows by more than one third.

To protect young children from the sun's rays, fit side blinds on the rear windows.

As a safety measure, do not leave:

- A child alone and unsupervised inside a vehicle.
- A child or an animal in a vehicle which is exposed to the sun, with the windows closed.
- The keys within reach of children inside the vehicle.

## Child seat at the rear

### Forward-facing or rearward-facing



► Move the vehicle's front seat forward and straighten the backrest so that the legs of the child in the forward-facing or rearward-facing child seat itself do not touch the vehicle's front seat.

► Check that the backrest of the forward-facing child seat is as close as possible to the backrest of the vehicle's rear seat, and ideally in contact with it.

### Centre rear seat

A child seat with a support leg must never be installed on the **centre rear passenger seat**.

## Child seat at the front



- Adjust the front passenger seat to the **highest and fully back longitudinal position, with the backrest straightened.**

### "Forward facing"



- ! You must leave the front passenger airbag active.

### "Rearward facing"



! The front passenger airbag must be deactivated before installing a rearward facing child seat. Otherwise, **the child risks being seriously injured or killed if the airbag is deployed.**



Warning label - Front passenger airbag

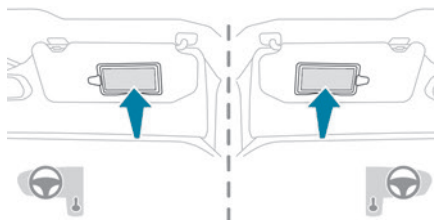

You must comply with the following instruction, as reminded by the warning label on both sides of the passenger sun visor:

NEVER use a rearward facing child restraint on a seat protected by an ACTIVE AIRBAG in front of it, DEATH or SERIOUS INJURY to the CHILD can occur.

## Deactivating the front passenger airbag



### Passenger airbag OFF

- ! To ensure the safety of the child, the front passenger airbag **MUST** be deactivated when a "rearward facing" child seat is installed on the front passenger seat. Otherwise, the child risks being seriously injured or killed in the event of deployment of the airbag.

- ! **Vehicles not equipped with a deactivation/reactivation control**  
Installing a "rearward facing" child seat on the front passenger seat is strictly prohibited - risk of death or serious injury in the event of airbag deployment!

## Deactivating/Reactivating the front passenger airbag

For vehicles on which it is fitted, the switch is located on the side of the dashboard.

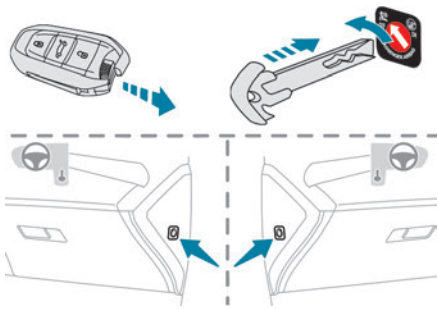

#### With the ignition off:

- ▶ To deactivate the airbag, turn the key in the switch to the "OFF" position.
- ▶ To reactivate it, turn the key to the "ON" position.

When the ignition is switched on:

 This warning lamp comes on and remains lit to signal deactivation.

Or

 This warning lamp comes on for about 1 minute to signal activation.

## "ISOFIX" mountings

The seats shown below are fitted with ISOFIX compliant mountings:

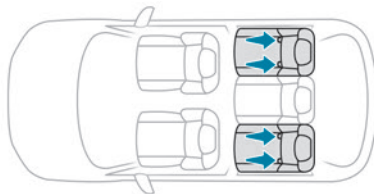

The mountings comprise three rings for each seat, indicated by a marking:

- Two rings **A**, located between the vehicle seat backrest and cushion.

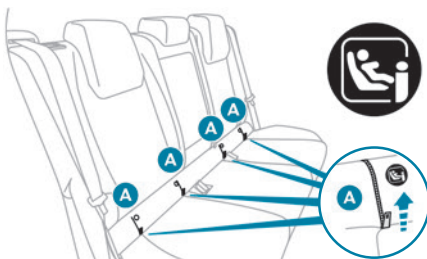

These rings are located behind zips.

The 2 latches on **ISOFIX child seats** are secured to them.

- One ring **B**, located behind the seat, called the **TOP TETHER**, for attaching seats fitted with an upper strap.

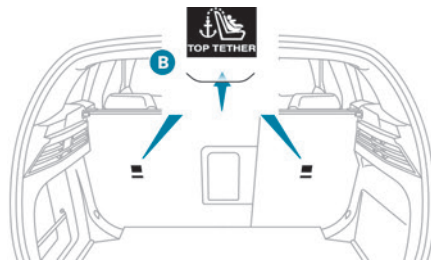

This system prevents the child seat from tipping forwards in the event of a front impact.

This ISOFIX mounting system provides fast, reliable and safe fitting of the child seat in the vehicle.

To secure the child seat to the **TOP TETHER**:

- ▶ Remove and stow the head restraint before installing the child seat on this seat (refit it once the child seat has been removed).
- ▶ Pass the strap of the child seat behind the seat backrest, centring it between the openings for the head restraint rods.
- ▶ Secure the upper strap hook to ring **B**.
- ▶ Tighten the upper strap.

**i** When fitting an ISOFIX child seat to the left-hand rear seat of the bench seat, before fitting the seat, first move the centre rear seat belt towards the middle of the vehicle, so as to avoid the seat interfering with the operation of the seat belt.

**!** An incorrectly installed child seat in a vehicle compromises the child's safety in the event of an accident. Strictly observe the fitting instructions provided in the user guide supplied with the child seat.

**i** For information about the options for fitting ISOFIX child seats in your vehicle, refer to the summary table.

## i-Size child seats

i-Size child seats have two latches that are anchored to the two rings **A**.

These i-Size child seats also have:

- either an upper strap that is attached to ring **B**.
- or a support leg that rests on the vehicle floor, compatible with the approved i-Size seat position.

Their role is to prevent the child seat from tipping forward in the event of a collision.

For more information on the **ISOFIX mountings**, refer to the corresponding section.

## Recommended child seats

### "RÖMER Baby-Safe 3 i-Size"

Size: 40 - 83 cm



#### From birth to 15 months

(up to 13 kg)

With or without its ISOFIX base.

Suitable for "rearward facing" installation only.

### "RÖMER TriFix 2 i-Size"

Size: 76 - 105 cm



#### From 15 months to 4 years

(from 9 to 22 kg)

Installed with ISOFIX and Top Tether mountings.

Suitable for "forward facing" installation only.

### "RÖMER KidFix i-Size"

Size: 100 - 150 cm



#### From 3.5 to 12 years

(from 15 to 36 kg)

Can be installed with or without ISOFIX mountings.

The child is restrained by the seat belt.

### "GRACO Booster"

Size: over 135 cm



(from 22 to 36 kg)

The child is restrained by the seat belt.

**i** Please follow the child restraint manufacturers' instructions for installing the appropriate child restraint in the vehicle.

**i** For the semi-universal or vehicle-specific child restraint (ISOFIX or belt-type child







restraint), refer to the list of vehicles provided in the child restraint user manual.

**i** Ensure that the installation location of the child restraint system inside the vehicle is correct.  
Refer to the summary table for the installation of child seats.

## Installing universal, ISOFIX and i-Size child seats

In compliance with European regulations, this table indicates the options for installing child seats secured using the seat belt and universally approved (a) as well as the largest **ISOFIX** and **i-Size** child seats for the seat positions fitted with **ISOFIX** anchorage points in the vehicle.

	Seat number					
	Front seats (d)		Rear seats (d)			
	1	3	4	5	6	
	3	1	4	5	6	
Front passenger airbag		Deactivated "OFF" (b)	Activated "ON" (c)			
Position compatible with a <b>universal (a)</b> child seat	no	yes (f) (i)	yes (f) (j)	yes	yes (e)	yes
Position compatible with an <b>i-Size</b> child seat	no	no		yes	no	yes
Position equipped with a <b>Top Tether</b> hook	no	no		yes	no	yes
<b>"Carycot"</b> type child seat	no	no		no	no	no

	Seat number					
	Front seats (d)			Rear seats (d)		
	1	3		4	5	6
	3	1		4	5	6
Front passenger airbag		Deactivated "OFF" (b)	Activated "ON" (c)			
"Rearward facing" ISOFIX child seat	no	no	no	R3 (g) (h)	no	R3 (g) (h)
"Forward facing" ISOFIX child seat	no	no		F3	no	F3
Child booster seat	no	B3		B3	no	B3

**Rules:**

- A position that is **i-Size** compatible is also compatible with **R1**, **R2** and **F2X**, **F2**, **B2**.
- A position that is **R3** compatible is also compatible with **R1** and **R2**.
- A position that is **F3** compatible is also compatible with **F2X** and **F2**.
- A position that is **B3** compatible is also compatible with **B2**.

- (a) Universal child seat: child seat that can be installed in all vehicles using the seat belt.
- (b) To install a "rearward facing" child seat at this seat position, the front passenger airbag must be deactivated ("OFF").

- (c) Only a "forward facing" child seat is authorised at this seat position with the front passenger airbag activated ("ON").
- (d) Depending on version, refer to the legislation in force in your country before installing a child in this seat position.
- (e) Never install a child seat with a support leg on the centre rear seat.
- (f) For a seat with height adjustment, adjust the seat to the highest position and move it fully back.
- (g) Adjust the driver's seat to the highest position.

- (h) Adjust the passenger seat to the intermediate forward longitudinal position.
- (i) For a universal "rearward facing" and/or "forward facing" (U) child seat in groups **0**, **0+**, **1**, **2** or **3**.
- (j) For a universal "forward facing" (UF) child seat in groups **1**, **2** or **3**.

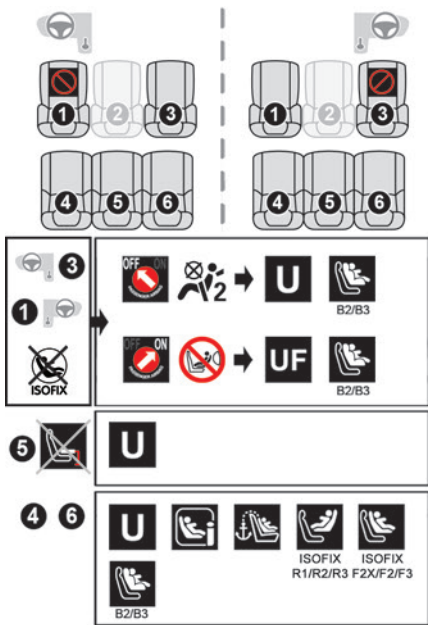

- Key**
- Seat position where the installation of a child seat is forbidden.
  - Front passenger airbag **deactivated**.
  - Front passenger airbag **activated**.
  - Seat position suitable for the installation of a child seat secured using the seat belt

and **universally approved "rearward facing" and/or "forward facing" (U)** for all sizes and weight groups.

**UF** Seat position suitable for the installation of a child seat secured using the seat belt and **universally approved "forward facing" (UF)** for groups **1, 2 and 3**, or dedicated to children between 76 and 150 cm in size only.

Seat position authorised for the installation of an **i-Size** child seat.  
 Seat position not suitable for the installation of a child seat with support leg.

Presence of a **Top Tether** anchorage point at the rear of the backrest, authorising the installation of an **universal ISOFIX child seat**.

"Rearward facing" **ISOFIX** child seat:

- **R1**: ISOFIX child seat for a **baby**.
- **R2**: ISOFIX **reduced size** child seat.
- **R3**: ISOFIX **large size** child seat.

"Forward facing" **ISOFIX** child seat:

- **F2X**: ISOFIX child seat **for toddlers**.
- **F2**: ISOFIX **reduced height** child seat.
- **F3**: ISOFIX **full height** child seat.

**Booster** child seat:

- **B2**: **reduced width booster** seat.
- **B3**: **full width booster** seat.

Seat position where the installation of an **ISOFIX** child seat is forbidden.

For seat adjustments, refer to the summary table **"Installing universal, ISOFIX and i-Size child seats"**.

## Manual child lock

The system prevents a rear door from being opened using its interior handle. The control is located on the edge of each rear door (indicated by a marking on the bodywork).

## Activation/Deactivation

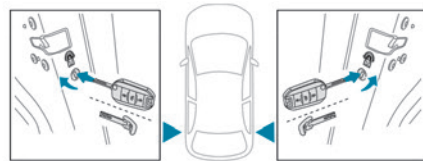

- ▶ To activate, turn the built-in key fully:
  - To the right on the left-hand rear door.
  - To the left on the right-hand rear door.
- ▶ To deactivate, turn it in the opposite direction.

## Driving recommendations

- ▶ Observe the driving regulations and remain vigilant whatever the traffic conditions.
- ▶ Monitor your environment and keep your hands on the wheel to be able to react to anything that may happen any time.
- ▶ Drive smoothly, anticipate the need for braking and maintain a longer safety distance, especially in bad weather.
- ▶ Stop the vehicle before performing operations that require sustained attention (e.g. settings).
- ▶ During long trips, take a break every 2 hours.

## Important!

**! Never leave the engine running in a closed space without sufficient ventilation.** Internal combustion engines emit toxic exhaust gases such as carbon monoxide. Danger of poisoning and death!

**! In very severe wintry conditions (temperature below -23°C), let the engine run for 4 minutes before moving off, to ensure the correct operation and durability of the mechanical components of your vehicle (engine and gearbox).**

**! Never drive with the parking brake applied.** Risk of overheating and damaging the braking system!

**! Never park the vehicle and never leave the engine running on a flammable surface (e.g. dry grass, dead leaves).** The vehicle exhaust system is very hot, even several minutes after the engine stops. Risk of fire!

**! Never drive on surfaces covered with vegetation (e.g. tall grass, accumulated dead leaves, crops, debris) such as a field, a country lane overgrown with bushes or a grassy verge.** This vegetation could come into contact with the vehicle's exhaust system or other systems which are very hot. Risk of fire!

**! Make sure you do not leave any item in the passenger compartment which could act like a magnifying glass under the effect of the sun's rays and cause a fire.** Risk of fire or damage to interior surfaces!

**! Never leave the vehicle unattended, with the engine running.** If you have to leave your vehicle with the engine running, apply the parking brake and put the gearbox into neutral or position **N** or **P** (depending on the type of gearbox).

**! Never leave children inside the vehicle unsupervised.**

## On flooded roads

We strongly advise against driving on flooded roads, as this could cause serious damage to the internal combustion engine or electric motor, the gearbox and the electrical systems of the vehicle.



If the vehicle absolutely must drive through a flooded section of road:

- ▶ Check that the depth of the water does not exceed 15 cm, taking account of waves that might be generated by other users.
  - ▶ Deactivate the Stop & Start function.
  - ▶ Drive as slowly as possible without stalling. In all cases, do not exceed 6 mph (10 km/h).
  - ▶ Do not stop and do not switch off the engine.
- On leaving the flooded road, as soon as safety conditions allow, make several light brake applications to dry the brake discs and pads. If in doubt about the state of your vehicle, contact a PEUGEOT dealer or a qualified workshop.

## Noise (Electric)

### On the outside

Due to the vehicle's quiet operation when driving, the driver must pay particular attention. When manoeuvring, the driver must always check the vehicle's immediate surroundings. At speeds of up to 19 mph (30 km/h), the pedestrian horn warns other road users of the vehicle's presence.

#### Cooling the traction battery

The cooling fan comes on during charging to cool the on-board charger and the traction battery.

### On the inside

During use, you may hear certain perfectly normal noises specific to electric vehicles, such as:

- Traction battery relay when starting.
- Vacuum pump when braking.
- Vehicle tyres or aerodynamics when driving.
- Jolting and knocking noise during hill starts.

## Towing

 Driving with a trailer places greater demands on the towing vehicle and particular care must be taken.

 Do not exceed the maximum towable weights.

**At altitude:** reduce the maximum load by 10% per 1,000 metres of altitude; the lower air density at high altitudes decreases engine performance.

 **New vehicle:** do not tow a trailer until the vehicle has driven at least 620 miles (1,000 kilometres).

 If the outside temperature is high, let the engine idle for 1 to 2 minutes after the vehicle comes to a stop, to help it to cool.

### Before setting off

#### Nose weight

► Distribute the load in the trailer so that the heaviest items are located as close as possible to the axle, and the nose weight (at the point where it joins your vehicle) approaches the maximum permitted, without exceeding it.

#### Tyres

► Check the tyre pressures of the towing vehicle and of the trailer, observing the recommended pressures.

#### Lighting

► Check the electrical signalling on the trailer and the headlamp beam height of your vehicle.

 If a genuine PEUGEOT towing device is used, the rear parking sensors will be deactivated automatically to avoid activating the audible signal.

### When driving

#### Cooling

Towing a trailer uphill causes the coolant temperature to increase. The maximum towable load depends on the gradient and the exterior temperature. The fan's cooling capacity does not increase with engine speed.

- Reduce speed and lower the engine speed to limit the amount of heating produced.
- Pay constant attention to the coolant temperature.



If this warning lamp and the **STOP** warning lamp come on, stop the vehicle and switch off the engine as soon as possible.

#### Brakes

Using the engine brake is recommended to limit the overheating of the brakes. Braking distances are increased when towing a trailer.

#### Side wind

Bear in mind that the vehicle will be more susceptible to wind when towing.

## Anti-theft protection

### Electronic immobiliser

The keys contain a code, which must be recognised by the vehicle before starting is possible.

If the system malfunctions, indicated by the display of a message, the engine will not start. Contact a PEUGEOT dealer.

## Starting/switching off the engine

- The electronic key must be present in the passenger compartment.

The electronic key is also detected in the boot.

If the electronic key is not detected, a message is displayed.

Move the electronic key so that the engine can be started or switched off.

If there is still a problem, refer to the "**Key not detected - Back-up starting or Back-up switch-off**" section.

## Starting



- ▶ With a **manual gearbox**, place the gear lever in neutral and fully depress the clutch pedal.
- ▶ With an **automatic gearbox**, select mode **P** or **N** and depress the brake pedal.
- ▶ Press the "**START/STOP**" button while maintaining pressure on the pedal until the engine starts.

### Diesel engines

With low temperatures and/or when the engine is cold, starting takes place only after the preheating warning lamp goes out.



If this warning lamp comes on after pressing the "**START/STOP**" button:

- ▶ Keep the pedal fully depressed and do not press the "**START/STOP**" button again until the engine is running at a stabilised engine speed. In all circumstances, if one of the starting conditions is not met, a message is displayed. In some circumstances, a message indicates that it is necessary to turn the steering wheel

while pressing the "**START/STOP**" button to assist unlocking of the steering column.

### Petrol engines

After a cold start, pre-heating the catalytic converter can cause noticeable engine vibrations, for anything up to 2 minutes (accelerated idle speed).

### Hybrid engines

The vehicle always starts with the petrol engine to ensure the efficiency of the catalytic converter and the availability of the brake assist.

After a few moments, the petrol engine may stop if the operating conditions allow (state of charge of the traction battery, external temperature, torque demand, selected driving mode).

- If the engine stalls, release the clutch pedal and fully depress it again, the engine will restart automatically.

## Starting rechargeable hybrid vehicles

- ▶ Fully depress the brake pedal and press the **START/STOP** button for approximately 2 seconds.
- ▶ Keep the foot on the pedal until the **READY** indicator lamp comes on, indicating the

activation of the rechargeable hybrid system (confirmed by an audible signal).

**!** To exit **Park** mode, wait for the **READY** indicator lamp to come on.

By default, the system starts in **Electric** mode. Depending on certain parameters (battery charge level or outside temperature), the system determines whether it is necessary to start the petrol engine.

It is possible to change the driving mode at any time using the mode selector.

**!** When the vehicle starts in electric mode, it makes no noise.

Pay particular attention to pedestrians and cyclists who may not hear the vehicle coming despite the pedestrian horn.

## Switching off

- ▶ Deactivate cruise control alone or Drive Assist Plus (depending on version).
- ▶ Immobilise the vehicle using the parking brake.
- ▶ With a **manual gearbox**, ideally put the gear lever into neutral.
- ▶ With an **automatic gearbox**, ideally select mode **P** or **N**.
- ▶ Press the **START/STOP** button.
- ▶ For rechargeable hybrid vehicles, before leaving the vehicle, check that the **READY** indicator lamp is switched off.

The automatic gearbox locks in mode **P**. In some circumstances, it is necessary to turn the steering wheel to lock the steering column.

**i** If the vehicle is not immobilised, the engine will not stop.

**!** With the engine off, the braking and steering assistance systems are also cut off - risk of loss of control of the vehicle!

**!** Never leave your vehicle with the electronic key still inside.

## Starting/Switching off electric vehicles

### Starting

The drive selector must be in mode **P**.

- ▶ Fully depress the brake pedal and briefly press the **START/STOP** button.
- ▶ Keep the foot on the brake pedal until the **READY** indicator lamp comes on and an audible signal is emitted, indicating that the vehicle is ready to drive.
- ▶ With the foot on the brake, select the mode **D/B** or **R**.
- ▶ Release the brake pedal, then accelerate.

On starting, the instrument panel lights up and the power indicator cursor moves to the "neutral" position. The steering column automatically

unlocks (you may hear a sound and feel the steering wheel move).

### Switching off

- ▶ Press the **START/STOP** button.
- Before exiting the vehicle, check that:
- The drive selector is in mode **P**.
  - The **READY** indicator lamp is off.

**i** If the driver's door is opened while the required conditions for stopping are not satisfied, an audible signal is emitted, accompanied by the display of a warning message.

## Switching on the ignition without starting the engine



With the electronic key in the passenger compartment, pressing the "**START/STOP**" button, **without depressing any of the pedals**, allows the ignition to be switched on without starting the engine.

- ▶ Press this button again to switch off the ignition and allow the vehicle to be locked.

## Key not detected

### Back-up starting

A back-up reader is fitted to the steering column, to enable the engine to be started if the system fails to detect the key in the recognition zone, or if the battery in the electronic key is flat.

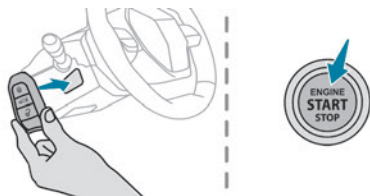

- ▶ Place and hold the remote control against the back-up reader.
- ▶ **With a manual gearbox**, place the gear lever in neutral, then fully depress the clutch pedal.
- ▶ **With an automatic gearbox or a drive selector**, select mode **P**, then depress the brake pedal.
- ▶ Press the **"START/STOP"** button. The engine starts.

### Back-up switch-off



If the electronic key is not detected or is no longer in the recognition zone, a message appears in the instrument panel when closing a door or trying to switch off the engine.

- ▶ To confirm the instruction to switch off the engine, press the **"START/STOP"** button for approximately 5 seconds.

In the event of a fault with the electronic key, contact a PEUGEOT dealer or a qualified workshop.

### Emergency switch-off

In case of emergency only, the engine can be switched off without conditions (even when driving).

- ▶ Press the **START/STOP** button for about 5 seconds.

## Electric parking brake

In automatic mode, this system applies the parking brake when the engine is switched off and releases it when the vehicle moves off.

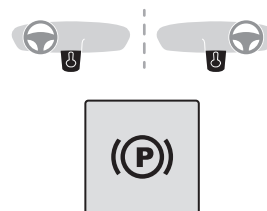

At any time, with the engine running:

- ▶ To apply the parking brake, briefly pull the control.
- ▶ To release it, briefly push the control while pressing the brake pedal.

Automatic mode is activated by default.

This automatic operation can be deactivated in certain situations.

### Indicator lamp

 This indicator lamp comes on both on the instrument panel and on the control to confirm that the parking brake has been applied, accompanied by display of the message **"Parking brake applied"**.

The indicator lamp goes out to confirm the release of the parking brake, accompanied by the display of the message **"Parking brake released"**.



The indicator lamp flashes in response to a manual request to apply or release the brake.

- ! In the event of a battery failure, the electric parking brake will not operate. As a safety measure, with a manual gearbox, if the parking brake is not applied, immobilise the vehicle by engaging a gear. As a safety measure, with an automatic gearbox or drive selector, if the parking brake is not applied, immobilise the vehicle by placing the supplied chock against one of the wheels. Contact a PEUGEOT dealer or a qualified workshop.

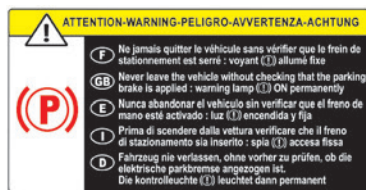

- ! Before leaving the vehicle, check that the parking brake is applied: the parking brake indicator lamps on the instrument panel and the control must be on fixed. If the parking brake is not applied, there is an audible signal and a message is displayed on opening the driver's door.

- ! Never leave a child alone inside the vehicle, as they could release the parking brake.

### ! When the vehicle is parked: on a steep slope, heavily loaded or during towing

With a manual gearbox, turn the wheels toward the pavement and engage a gear. With an automatic gearbox or a drive selector, turn the wheels toward the pavement and select mode **P**. When towing, the vehicle is approved for parking on slopes of up to 12%.

## Manual operation

### Manual release

With the ignition on or engine running:

- ▶ Press the brake pedal.
- ▶ While maintaining pressure on the brake pedal, briefly push the control.

- i If the brake pedal is not depressed, the parking brake is not released and a message is displayed.

### Manual application

With the vehicle stationary:

- ▶ Briefly pull the control.

The control indicator lamp flashes to confirm the application request.

## Automatic operation

### Automatic release

First ensure that the engine is running and that the driver's door is closed.

**The electric parking brake gradually releases automatically as the vehicle moves off.**

#### With a manual gearbox

- ▶ Fully depress the clutch pedal and engage first gear or reverse.
- ▶ Depress the accelerator pedal and release the clutch pedal.

#### With an automatic gearbox

- ▶ Depress the brake pedal.
- ▶ Select mode **D**, **M** or **R**.
- ▶ Release the brake pedal and depress the accelerator pedal.

#### With a drive selector

- ▶ Depress the brake pedal.
- ▶ Select mode **D**, **B** or **R**.
- ▶ Release the brake pedal and depress the accelerator pedal.

- i With an automatic gearbox or drive selector, if the brake does not release automatically, check that the front doors are properly closed.

- ! When stationary with the engine running, do not depress the accelerator pedal unnecessarily. Risk of parking brake release.

## Automatic application

With the vehicle stationary, the parking brake is applied automatically when the engine is switched off.

**!** It is not applied automatically if the engine stalls or enters STOP mode with Stop & Start.

**i** In automatic mode, the parking brake can be manually applied or released at any time using the control.

## Special cases

### Immobilising the vehicle with the engine running

To immobilise the vehicle with the engine running, briefly pull the control.

### Parking the vehicle with the brake released

**!** In very cold conditions (ice), applying the parking brake is not recommended.

To immobilise the vehicle, engage a gear or place the chocks against one of the wheels.

**i** With an automatic gearbox or drive selector, mode **P** is automatically

selected when the ignition is switched off. The wheels are blocked.

For more information on **Free-wheeling**, refer to the corresponding section.

**i** With an automatic gearbox or a drive selector, if you open the driver's door while mode **N** is engaged, an audible signal will sound and mode **P** will be engaged. The audible signal stops when the driver's door is closed.

## Deactivating automatic operation

In some situations, for example when it is extremely cold or when towing (e.g. caravan, breakdown), it may be necessary to deactivate automatic operation of the system.

- ▶ Start the engine.
- ▶ Use the control to apply the parking brake, if it is released.
- ▶ Take your foot fully off the brake pedal.
- ▶ Push the control for 10 to a maximum of 15 seconds.
- ▶ Release the control.
- ▶ Depress and hold the brake pedal.
- ▶ Pull the control for 2 seconds.

 This indicator lamp on the instrument panel comes on to confirm deactivation of the automatic functions.

- ▶ Release the control and the brake pedal.

From this point onwards, only the manual functions, using the control, allow the parking brake to be applied and released.



- ▶ Follow this procedure again to reactivate automatic operation (confirmed by the indicator lamp on the instrument panel going out).

## Emergency braking

If depressing the brake pedal fails to provide effective braking or in exceptional circumstances (e.g. driver unwell, assisted driving), the vehicle can be braked by sustained pulling on the electric parking brake control. Braking continues for as long as the control is kept pulled, and ceases when the control is released.

The ABS and DSC systems stabilise the vehicle during emergency braking.

If emergency braking malfunctions, the message "**Parking brake fault**" will be displayed on the instrument panel.

  If the ABS and DSC systems malfunction, indicated by lighting one or both warning lamps on the instrument panel, the vehicle's stability is no longer ensured.

- ▶ In this case, ensure the vehicle's stability by successive and repeated "pull-release" actions on the electric parking brake control until the vehicle comes to a complete stop.

## Manual gearbox

### Engaging 5<sup>th</sup> or 6<sup>th</sup> gear

- ▶ Move the gear selector fully to the right to engage 5<sup>th</sup> or 6<sup>th</sup> gear.

**!** Failure to follow this instruction could cause permanent damage to the gearbox (inadvertent engagement of 3<sup>rd</sup> or 4<sup>th</sup> gear).

### Engaging reverse gear



- ▶ Raise the ring under the knob and move the gear selector to the left, then forwards.

**!** Only engage reverse gear when the vehicle is stationary with the engine at idle.

- i** As a safety precaution and to facilitate engine starting:
  - ▶ Always select neutral.
  - ▶ Press the clutch pedal.

## Automatic gearbox (EAT8/e-EAT8)

### For petrol/Diesel versions

Automatic 8-speed gearbox with push selector. It also offers a manual mode with gear changes via control paddles located behind the steering wheel.

### For rechargeable hybrid versions

Automatic 8-speed gearbox with push selector and regenerative braking function. With the exception of the manual mode and regenerative braking function, its operation is identical to that of other EAT8 gearboxes.

### Push selector

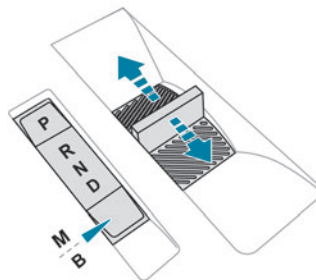

- P.** Auto Park  
Press this button to switch to Parking mode. For parking the vehicle: the front wheels are blocked.
  - R.** Reverse
  - N.** Neutral  
To free-wheel and move the vehicle, with the ignition off.  
For more information on **Free-wheeling**, refer to the corresponding section.
  - D.** Driving in automatic mode  
The gearbox manages gear changes according to the style of driving, the road profile and the vehicle load.
  - M.** Driving in manual mode (Petrol / Diesel)  
Press this button to switch to manual mode. The driver changes gear using the steering-mounted controls.
  - B.** Driving in automatic mode with regenerative braking function (Rechargeable hybrid)  
Press this button to activate the regenerative braking function.  
The gearbox also manages braking when the accelerator pedal is released.
- ▶ In mode **N**, with your foot on the brake pedal, push without passing the point of resistance:
    - Forwards, mode **R** is selected.
    - Backwards, mode **D** is selected.
- Release the selector fully after each push; it will then return to its initial position.**

## Special cases

To avoid mode **N** (quick change from **D** to **R** and back again):

- ▶ In mode **R**, push backwards past the point of resistance, mode **D** is selected.
- ▶ In mode **D**, push forwards past the point of resistance, mode **R** is selected.
- ▶ To return to mode **N**, push without passing the point of resistance.

## Steering-mounted controls

(Depending on equipment)

In mode **M** or **D**, the steering-mounted control paddles can be used to change gear manually. They cannot be used to select neutral or to engage or disengage reverse gear.

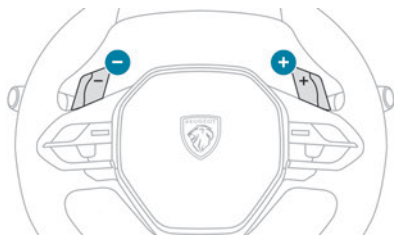

- ▶ Pull the "+" or "-" paddle towards you and release to shift up or down a gear, respectively.

## Information displayed on the instrument panel

When the ignition is switched on, the gearbox status is displayed on the instrument panel:

- P** Parking
- R** Reverse
- N** Neutral
- D1...8** Automatic forward gear
- B1...8** Automatic forward gear with regenerative braking function activated
- M1...8** Manual forward gear

In all-electric driving, the gear engaged is not indicated.

The state of the gearbox remains displayed on the instrument panel for a few seconds after switching off the ignition.

## Operation

Only appropriate mode change instructions are validated.

With the engine running, if it is necessary to depress the brake pedal to change modes, an alert message will be displayed on the instrument panel.

**!** With the engine running and the brakes released, if **R**, **D** or **M** is selected, the vehicle moves off, even without pressing the accelerator pedal.

Never depress the accelerator and brake pedals at the same time - risk of damage to the gearbox!

**i** If you open the driver's door while mode **N** is engaged, an audible signal will sound and mode **P** will be engaged. The

audible signal stops when the driver's door is closed.

**!** At speeds below 3 mph (5 km/h), opening the driver's door will engage mode **P** - risk of sudden braking!

**!** In the event of battery failure, it is essential to place the chock(s) supplied with the tool kit against one of the wheels to immobilise the vehicle.

## Special aspects of automatic mode

The gearbox selects the gear that provides optimal performance based on ambient temperature, road profile, vehicle loading and driving style.

For maximum acceleration, press the accelerator fully down (kick-down). The gearbox changes down automatically or holds the selected gear until the maximum engine speed is reached. Steering mounted controls allow the driver to temporarily select a gear, if the vehicle speed and engine speed conditions permit.

## Special aspects of manual mode

The gearbox only changes from one gear to another if the vehicle speed and engine speed conditions permit.

## Regenerative braking (Brake function)

The regenerative braking function emulates engine braking, slowing the vehicle with no need to depress the brake pedal. When the driver releases the accelerator pedal, the vehicle slows down more quickly.

The energy recovered when the accelerator pedal is released is used to partially recharge the traction battery.

 This partial recharging has no effect on the charge level indicator.

 The resulting deceleration of the vehicle does not cause the brake lamps to come on.

► From mode **D**, press button **B** to activate/deactivate the function.

**D** on the instrument panel is replaced with **B**. The state of the function is not saved when the ignition is switched off.

 In some situations (e.g. battery full, extreme temperatures), the amount of regenerative braking may be temporarily limited, resulting in less deceleration. The driver must remain alert to traffic conditions and must always be ready to use the brake pedal.

### Regenerative braking using the brake pedal

Energy recovery can also be produced by depressing the brake pedal in order to partially recharge the traction battery, without affecting the charge level indicator.

## Starting the vehicle

- Fully depress the brake pedal.
  - Start the engine.
  - With your foot on the brake pedal, push once or twice backwards to select automatic mode **D**, or forwards to shift into reverse gear **R**.
  - Release the brake pedal.
  - Accelerate gradually to automatically release the electric parking brake.
- The vehicle moves off immediately.

### Automatic gearbox

Never try to start the engine by pushing the vehicle.

## Switching the vehicle off

Regardless of the current gearbox mode, mode **P** is immediately engaged automatically when the ignition is switched off. However, in mode **N**, mode **P** will be engaged after a delay of 5 seconds (time to enable free-wheeling mode).

Check that mode **P** has been engaged and that the electric parking brake was applied automatically; if not, apply it manually.

 The corresponding indicator lamps on the gear selector and the electric parking brake control must be on, as well as the indicator lamps on the instrument panel.

## Gearbox malfunction

 This warning lamp comes on, accompanied by an audible signal and the display of a message.

Go to a PEUGEOT dealer or a qualified workshop.

Do not drive faster than 62 mph (100 km/h), keeping to the speed limit.

### Switching of the gearbox to back-up mode

Mode **D** locks in third gear.

The paddles on the steering wheel do not work and mode **M** is no longer accessible.

You may feel a significant jolt on engaging reverse gear. This will not damage the gearbox.

## Selector malfunction

### Minor malfunction

 This warning lamp comes on, accompanied by the display of a message and an audible signal.

Drive carefully.

Go to a PEUGEOT dealer or a qualified workshop.

In some cases, the selector indicator lamps may no longer come on, but the gearbox state is still displayed on the instrument panel.

### Major malfunction



This warning lamp comes on, accompanied by the display of a message.

#### ! You must stop the vehicle.

Stop as soon as it is safe to do so and switch off the ignition.

Contact a PEUGEOT dealer or a qualified workshop.

## Electric dual-clutch automatic gearbox (e-DCS6/7)

6-speed or 7-speed electrified dual-clutch automatic gearbox with push selector for respectively hybrid vehicles or rechargeable hybrid vehicles.

It also offers a manual mode with gear changes via control paddles located behind the steering wheel.

It includes the 48 V electric motor, which improves the performance of the petrol engine, reduces fuel consumption and drives in all-electric.

## Push selector

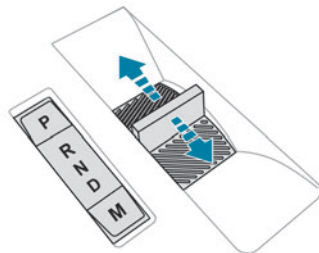

### For hybrid vehicles

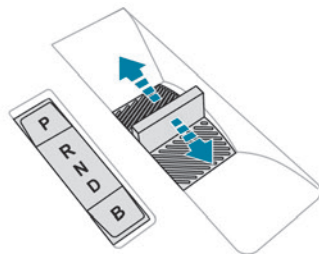

### For rechargeable hybrid vehicles

#### P. Auto Park

Press this button to switch to Parking mode.

For parking the vehicle: the front wheels are blocked.

#### R. Reverse

#### N. Neutral

To free-wheel and move the vehicle, with the ignition off.

For more information on **Free-wheeling**, refer to the corresponding section.

#### D. Driving in automatic mode

The gearbox manages gear changes according to the style of driving, the road profile and the vehicle load.

#### M. Driving in manual mode (Hybrid)

Press this button to switch to manual mode.

The driver changes gear using the steering-mounted controls.

#### B. Driving in automatic mode with regenerative braking function (Rechargeable hybrid)

Press this button to activate the regenerative braking function.

The gearbox also manages braking when the accelerator pedal is released.

► In mode **N**, with your foot on the brake pedal, push without passing the point of resistance:

- Forwards, mode **R** is selected.
- Backwards, mode **D** is selected.

**Release the selector fully after each push; it will then return to its initial position.**

### Special cases

To avoid mode **N** (quick change from **D** to **R** and back again):

- In mode **R**, push backwards past the point of resistance, mode **D** is selected.
- In mode **D**, push forwards past the point of resistance, mode **R** is selected.

► To return to mode **N**, push without passing the point of resistance.

## Steering-mounted controls

(Depending on equipment)

In mode **M** or **D**, the steering-mounted control paddles can be used to change gear manually. They cannot be used to select neutral or to engage or disengage reverse gear.

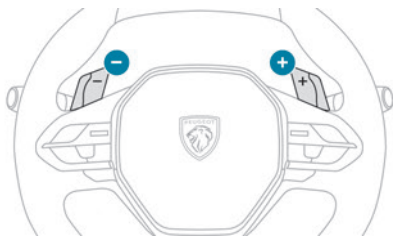

► Pull the "+" or "-" paddle towards you and release to shift up or down a gear, respectively.

## Electric motor

The electric motor included in the automatic gearbox, which is used for the first start, provides 12 V power supply via the DC/DC converter and provides electric assistance to the petrol engine. The electric motor has the following features:

- Provide an additional torque to the gearbox, optimising the performance of the petrol engine.
- Recover the kinetic energy of the deceleration phases, converting it into electrical energy, which can be used for traction or for the power supply of electrical accessories installed on the vehicle.

– Recharge the 48 V traction battery when the state of charge is too low.

– Provide all-electric driving only.

These features are achieved through the following functions set of automatic operating mode:

- e-Boost.
- e-Creeping.
- e-Launch.
- e-Queueing.
- e-Parking.

A manual operating mode is also available to activate/deactivate the restart of the petrol engine while driving: the e-Auto mode.

**i** When mode **P** or **N** is selected on the automatic gearbox, the noise level in the engine compartment may increase due to the start of the charging phase of the traction battery: this is normal and does not represent a malfunction.

## Information displayed on the instrument panel

When the ignition is switched on, the gearbox status is displayed on the instrument panel:

<b>P</b>	Parking
<b>R</b>	Reverse
<b>N</b>	Neutral
<b>D</b>	Automatic forward gear (Hybrid)
<b>M1...6</b>	Manual forward gear (Hybrid)

**D1...7** Automatic forward gear (Rechargeable hybrid)

**B1...7** Automatic forward gear with regenerative braking function (Rechargeable hybrid)

The gear engaged is also displayed in Sport mode.

However, in all-electric driving, the gear engaged is not indicated.

The state of the gearbox remains displayed on the instrument panel for a few seconds after switching off the ignition.

## Operation

Only appropriate mode change instructions are validated.

With the engine running, if it is necessary to depress the brake pedal to change modes, an alert message will be displayed on the instrument panel.

**!** With the engine running and the brakes released, if **R**, **D** or **M** is selected, the vehicle moves off, even without pressing the accelerator pedal.

Never depress the accelerator and brake pedals at the same time - risk of damage to the gearbox!

**i** If you open the driver's door while mode **N** is engaged, an audible signal will sound and mode **P** will be engaged. The

audible signal stops when the driver's door is closed.

**!** At speeds below 3 mph (5 km/h), opening the driver's door will engage mode **P** - risk of sudden braking!

**!** In the event of battery failure, it is essential to place the chock(s) supplied with the tool kit against one of the wheels to immobilise the vehicle.

## Special aspects of automatic mode

These functions respond to common driving situations where the electric motor is available to provide additional power or zero-emission driving.

**i** These functions are only available if the traction battery is sufficiently charged. These five functions cannot be deactivated.

### e-Launch

With the petrol engine off, this function allows the vehicle to run in electric mode without affecting performance.

By depressing the accelerator pedal, the vehicle starts to drive as soon as the mode **D** or **R** of the automatic gearbox is selected.

### e-Creeping

With the petrol engine off, by releasing the brake pedal, this function allows the vehicle to be moved forward or backward in electric mode without having to depress the accelerator pedal, as soon as the mode **D** or **R** of the automatic gearbox is selected.

### e-Queueing

This function makes it possible to follow a queue of vehicles with several stops followed by restarts of the vehicle, using the e-Creeping, e-Launch and electric driving modes.

### e-Parking

This function allows parking manoeuvres to be carried out at reduced speed with the help of the electric motor when the mode **D** or **R** of the automatic gearbox is selected.

### e-Boost

This function allows simultaneous operation of the petrol engine and the electric motor, combined with the automatic gearbox.

By fully depressing the accelerator pedal ("kick-down" function), when the traction battery is fully charged, it is possible to exceed the torque of the petrol engine alone, thanks to the additional torque provided by the electric motor.

**i** Repeated use of the brake pedal causes the restart of petrol engine to provide braking assistance.

## Special aspects of manual mode

The gearbox only changes from one gear to another if the vehicle speed and engine speed conditions permit.

The petrol engine can also be switched off in manual mode when stopped in traffic or when the accelerator pedal is released.

For hybrid vehicles, the all-electric potential of the driving mode used (**Normal** or **Eco**) is also retained.

For rechargeable hybrid vehicles, the all-electric potential of the driving mode used (**Hybrid** or **Electric**) is also retained.

**i** Using the steering wheel paddles also causes the restarting of petrol engine. If high traction is required, the driver can deactivate the e-Auto mode using the touch screen application.

## Regenerative braking (Brake function)

The regenerative braking function emulates engine braking, slowing the vehicle with no need to depress the brake pedal. When the driver releases the accelerator pedal, the vehicle slows down more quickly.

The energy recovered when the accelerator pedal is released is used to partially recharge the traction battery.





 This partial recharging has no effect on the charge level indicator.

 The resulting deceleration of the vehicle does not cause the brake lamps to come on.

► From mode **D**, press button **B** to activate/deactivate the function.

**D** on the instrument panel is replaced with **B**. The state of the function is not saved when the ignition is switched off.

 In some situations (e.g. battery full, extreme temperatures), the amount of regenerative braking may be temporarily limited, resulting in less deceleration. The driver must remain alert to traffic conditions and must always be ready to use the brake pedal.

 **Regenerative braking using the brake pedal**

Energy recovery can also be produced by depressing the brake pedal in order to partially recharge the traction battery, without affecting the charge level indicator.

## Starting the vehicle

► Fully depress the brake pedal.

- Start the petrol engine by depressing the brake pedal until the engine is running at a stabilised engine speed.
- With your foot on the brake pedal, push once or twice backwards to select automatic mode **D**, or forwards to shift into reverse gear **R**.
- Release the brake pedal.
- Accelerate gradually to automatically release the electric parking brake.

The petrol engine may stop after the first start if operating conditions allow (e.g. state of charge of the traction battery, external temperature, efficiency of the catalytic converter, torque demand, selected driving mode, thermal comfort of the passenger compartment). Then, the vehicle moves off immediately in all-electric (e-Launch function).

## Switching the vehicle off

Regardless of the current gearbox mode, mode **P** is immediately engaged automatically when the ignition is switched off.

However, in mode **N**, mode **P** will be engaged after a delay of 5 seconds (time to enable free-wheeling mode).

Check that mode **P** has been engaged and that the electric parking brake was applied automatically; if not, apply it manually.

 The corresponding indicator lamps on the gear selector and the electric parking brake control must be on, as well as the indicator lamps on the instrument panel.

## Gearbox malfunction



This warning lamp comes on, accompanied by an audible signal and the display of a message.

Go to a PEUGEOT dealer or a qualified workshop.

Do not drive faster than 62 mph (100 km/h), keeping to the speed limit.

### Switching of the gearbox to back-up mode

Depending on the malfunction, the gearbox only shifts in odd or even gears, locks in one gear or loses some gears.

For hybrid vehicles, the paddles on the steering wheel do not work and mode **M** is no longer accessible.

You may feel a significant jolt on engaging reverse gear. This will not damage the gearbox.

## Selector malfunction

### Minor malfunction



This warning lamp comes on, accompanied by the display of a message and an audible signal.

Drive carefully.

Go to a PEUGEOT dealer or a qualified workshop.

In some cases, the selector indicator lamps may no longer come on, but the gearbox state is still displayed on the instrument panel.

## Major malfunction



This warning lamp comes on, accompanied by the display of a message.

### **!** You must stop the vehicle.

Stop as soon as it is safe to do so and switch off the ignition.

Contact a PEUGEOT dealer or a qualified workshop.

## Drive selector (Electric)

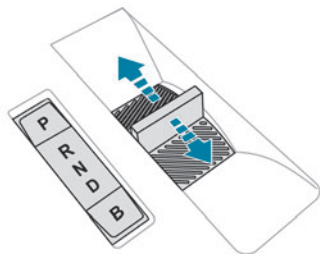

The drive selector is a pulse selector with a regenerative braking function.

The drive selector provides traction control based on the driving style, the road profile and the vehicle load.

With regenerative braking activated, it also manages engine braking when the accelerator pedal is released.

### P. Park

Button for parking the vehicle: the front wheels are locked (the button lights up to indicate that it is activated).

### R. Reverse

To engage reverse gear, with your foot on the brake pedal.

### N. Neutral

To move the vehicle with the ignition off and so allow it to free-wheel.

For more information on **Free-wheeling**, refer to the corresponding section.

### D. Drive (automatic forward gear)

### B. Brake (regenerative braking)

Regenerative braking (the button lights up to indicate its activation).

## Information displayed on the instrument panel

When the ignition is switched on, the drive selector status is displayed on the instrument panel:

**P** : Park.

**R** : Reverse.

**N** : Neutral.

**D** : Drive (automatic forward gear).

**B** : Brake (regenerative braking activated).

## Operation

► In mode **N**, with your foot on the brake pedal, push without passing the point of resistance:

- Forwards, mode **R** is selected.
- Backwards, mode **D** is selected.

**Release the selector fully after each push; it will then return to its initial position.**

### Special cases

To avoid mode **N** (quick change from **D** to **R** and back again):

- In mode **R**, push backwards past the point of resistance, mode **D** is selected.
- In mode **D**, push forwards past the point of resistance, mode **R** is selected.
- To return to mode **N**, push without passing the point of resistance.

## Regenerative braking

### With the Brake function and when decelerating

The Brake function emulates engine braking, slowing the vehicle with no need to depress the brake pedal. The vehicle slows more quickly when the driver releases the accelerator pedal. The energy recovered when the accelerator pedal is released is then used to partially recharge the traction battery, thereby increasing the vehicle's driving range.

**!** The resulting deceleration of the vehicle does not cause the brake lamps to come on.

► From mode **D**, press button **B** to activate/deactivate the function (the button lights up when the function is activated).  
**D** on the instrument panel is replaced with **B**.  
 The system status is not saved when the ignition is switched off.

! In some situations (e.g. battery full, extreme temperatures), the amount of regenerative braking may be temporarily limited, resulting in less deceleration.  
 The driver must remain alert to traffic conditions and must always be ready to use the brake pedal.

### With the brake pedal

When the brake pedal is depressed, the intelligent braking system automatically recovers some of the energy and uses it to recharge the traction battery.

This energy recovery also reduces use of the brake pads, thereby limiting their wear.

i The driver may experience a different sensation when depressing the brake pedal compared to a vehicle without regenerative braking.

## Driving modes

The driving modes available depend on the engine and equipment of the vehicle.

Driving modes are selected using the following control:

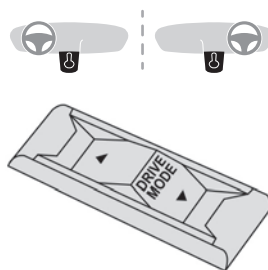

► Press the control to display the modes on the instrument panel.

► Press the control again to change mode.

With an electric vehicle, when starting the vehicle, no mode can be selected until the

**READY** indicator lamp is displayed.

When the message disappears, the selected mode is activated and remains indicated on the

instrument panel (except **Normal** mode).  
 The selected mode is activated immediately.

## For petrol, Diesel or hybrid versions

Whenever the ignition is switched on, **Normal** driving mode is selected by default.

### Normal

To restore the default settings.

### Eco

To reduce energy consumption by reducing the performance of the heating and air conditioning, without deactivating them.

### Sport

With a manual gearbox: to obtain more dynamic driving with action on the power steering, accelerator and the possibility of displaying the vehicle's dynamic settings on the instrument panel.

With an automatic gearbox: to obtain more dynamic driving with action on the power steering, accelerator, gear changes, displaying the vehicle's dynamic settings on the instrument panel (depending on version) and activation/deactivation of the display colour (depending on version).

The selection of the **Sport** mode deactivates the Stop & Start function / e-Auto mode.

### i Coasting mode (Petrol or Diesel)

Depending on version and engine, with the gear selector in mode **D**, in **Eco** and **Normal** modes, gradually and fully releasing the accelerator pedal allows free-wheeling which can save fuel.

A drop in engine speed is normal (rev counter at idle, drop in engine noise).

## For rechargeable hybrid versions

Whenever the ignition is switched on, **Electric** driving mode is selected by default.

### Electric

Allows driving using 100% electrical energy. The maximum speed is approximately 84 mph (135 km/h).

When starting the vehicle, if the conditions do not allow the activation or retention of **Electric** mode, the message "**Electric mode currently unavailable**" is displayed on the instrument panel. The vehicle automatically changes to **Hybrid** mode.

### Conditions of activation

- Adequate battery charge level. Charging the vehicle after each drive is therefore recommended. **Electric** mode is available as long as there is power left in the battery.
- Outside temperature between approximately -5°C and 45°C.

### Manually exiting the mode

- ▶ Fully depress the accelerator pedal, or
- ▶ Select another mode.

**i** In case of non-use of the vehicle for a long period (several months), a restart of the petrol engine may occur even if the battery is charged.

**!** In the event of multiple starts of the internal combustion engine without a

sufficient rise in temperature, **Electric** mode may be temporarily unavailable (natural phenomenon of dilution of fuel in oil). The message "**Electric mode unavailable: automatic operation in progress**" then appears on the instrument panel. To regain normal electrical operation, drive approximately 50 miles (80 km) in "motorway" conditions or approximately 125 miles (200 km) in urban conditions. This phenomenon does not cause any mechanical or electrical damage. It can occur several times in the life of the vehicle.

### Hybrid

To optimise the vehicle's fuel consumption by managing the **alternating or simultaneous operation of the two types of engine**, depending on driving conditions and driving style.

In **Hybrid** mode, it is possible to drive in 100% electric mode if the battery charge level is sufficient and acceleration requirements are moderate.

### Sport

To obtain more dynamic driving in order to benefit from the maximum performance of the vehicle.

Electric power is used to supplement the petrol engine as long as there is energy left in the battery.

## For electric versions

Each time the ignition is switched on, **Normal** mode is selected by default.

### Normal

This optimises the driving range and dynamic performance.

To obtain maximum torque and power, depress the accelerator pedal fully.

### Eco

Optimises energy consumption, by reducing the output of the heating and air conditioning (without actually deactivating them) and limiting both motor torque and power.

### Sport

Enables more dynamic driving, acting on the power steering, accelerator and gear changes with a drive selector and the possibility of displaying the vehicle's dynamic settings on the instrument panel.

## Hill start assist

This system keeps the vehicle briefly stationary (for approximately 2 seconds) when making a hill start, while you transfer your foot from the brake pedal to the accelerator pedal.

The system is only active when:

- The vehicle is completely stationary, with your foot on the brake pedal.
- Certain slope conditions are met.
- The driver's door is closed.

**!** Do not leave the vehicle while it is being held temporarily by hill start assist. If someone needs to get out of the vehicle with the engine running, apply the parking brake manually. Then check that the parking brake indicator lamp and the **P** indicator lamp in the electric parking brake control are on fixed.

**!** The hill start assist function cannot be deactivated. However, using the parking brake to immobilise the vehicle interrupts its operation.

## Operation

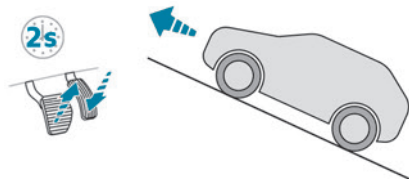

**Facing uphill, with the vehicle stationary, the vehicle is held for a short time when the driver releases the brake pedal:**

- If first gear or neutral is engaged on a manual gearbox.
- If mode **D**, **M** or **B** is selected on an automatic gearbox.
- If mode **D** or **B** is selected on the drive selector.



**Facing downhill, with the vehicle stationary and reverse gear engaged, the vehicle is held for a short time when the driver releases the brake pedal.**

## Malfunction



If the event of a malfunction, these warning lamps light up on the instrument panel, accompanied by the display of a message.

Have it checked by a PEUGEOT dealer or a qualified workshop.

## Gear shift indicator

(Depending on engine)

This system is designed to reduce fuel consumption by recommending the most suitable gear.

## Operation

Depending on the driving situation and the vehicle's equipment, the system may recommend skipping one or more gears. Gear engagement recommendations are not to be considered mandatory. Indeed, the

configuration of the road, the traffic density and safety remain determining factors when choosing the best gear. Therefore, the driver remains responsible for deciding whether or not to follow the system's advice.

The system cannot be deactivated.

**i** With an automatic gearbox, the system is only active in manual operation.



The information appears on the instrument panel, in the form of an arrow and the recommended gear.

**i** The system adapts the gear change instructions according to the driving conditions (e.g. slope, load) and driving style (e.g. power demand, acceleration, braking). The system never suggests:

- engaging first gear.
- engaging reverse gear.

## Stop & Start (Petrol or Diesel)

The Stop & Start function puts the engine temporarily into standby - STOP mode - during phases when the vehicle is stationary (e.g. red lights, traffic jams). The engine automatically restarts - START mode - as soon as the driver indicates the intention of moving off again. Primarily designed for urban use, the function is intended to reduce fuel consumption and

exhaust emissions as well as the noise level when stationary.

The function does not affect the functionalities of the vehicle, in particular the braking.

## Deactivation/Reactivation

By default, the function is activated when the ignition is switched on.



It is configured in the **ADAS** touch screen application.

or

Direct access to the **Shortcuts for driving aids**.

The display of a message on the instrument panel confirms the change of state.

If the function is deactivated while the engine is in STOP mode, it will restart immediately.

## Associated indicator lamps



Function activated: engine on standby (STOP mode)



Function deactivated or malfunction



### Opening the bonnet

Before doing anything under the bonnet, deactivate the Stop & Start system to avoid

any risk of injury caused by the engine restarting automatically.



### ! Driving on flooded roads

Before entering into a flooded area, it is strongly recommended that you deactivate the Stop & Start system.

For more information on **Driving recommendations**, particularly on flooded roads, refer to the corresponding section.

## Operation

### Main conditions for operation

- The driver's door must be closed.
- The driver's seat belt must be fastened.
- The level of charge in the battery must be sufficient.
- The temperature of the engine must be within its nominal operating range.
- The outside temperature must be between 0°C and 35°C.

## Putting the engine into standby (STOP mode)

The engine automatically enters standby mode as soon as the driver indicates their intention to stop:

- **With a manual gearbox:** when you place the gear lever in neutral and release the clutch pedal.

- **With an automatic gearbox:** with the gear selector in mode **D** or **M**, when the brake pedal is depressed until the vehicle stops or when the mode **N** is selected, with the vehicle stationary.

### Time counter

A time counter adds up the time spent in standby during the journey. It is reset to zero every time the ignition is switched on.

### Special cases

The engine will not go into standby if the conditions for operation are not met and in the following cases:

- Steep slope (ascending or descending).
- Sport mode selected (depending on equipment).
- Needed to maintain a comfortable temperature in the passenger compartment.
- Demisting active.



In these cases, this indicator lamp flashes for a few seconds, then goes off.

**i** After the engine has restarted, STOP mode is not available until the vehicle has reached a speed of 5 mph (8 km/h).

**i** During parking manoeuvres, STOP mode is not available for a few seconds after coming out of reverse gear or turning the steering wheel.

### Restarting the engine (START mode)

The engine automatically restarts as soon as the driver indicates the intention of moving off again:

**With a manual gearbox:** when the clutch pedal is fully depressed.

**With an automatic gearbox:**

- With the selector in mode **D** or **M**: when the brake pedal is released.
- With the selector in mode **N** and the brake pedal released: when the mode **D** or **M** is selected.
- With the selector in mode **P** and the brake pedal depressed: when the mode **R**, **N**, **D** or **M** is selected.
- When the reverse gear is engaged.

### Special cases

The engine will restart automatically if the conditions for operation are met again and in the following cases:

- Deselecting the Sport mode (depending on equipment).

- With a manual gearbox: vehicle speed exceeds 2.5 mph (4 km/h).
- With an automatic gearbox, in mode **N**, vehicle speed exceeds 0.6 mph (1 km/h).



In these cases, this indicator lamp flashes for a few seconds, then goes off.

## Malfunctions



In the event of a fault with the system, this warning lamp flashes for a few moments on the instrument panel, then remains on, accompanied by the display of a message. Have it checked by a PEUGEOT dealer or a qualified workshop.

### The vehicle stalls in STOP mode

All of the instrument panel warning lamps come on if there is a fault.

► Switch off the ignition then start the engine again with the key or the **START/STOP** button.

### ! 12 V battery

The Stop & Start system requires a 12 V battery of specific technology and specification.

All work must be carried out only by a PEUGEOT dealer or a qualified workshop

## e-Auto mode (Hybrid)

The petrol engine stops when low power or torque is required and in stabilised conditions. The petrol engine is restarted by the belt starter.

**The e-Auto mode can switch off the petrol engine in the following cases:**

- When the operating strategies permit.
- Vehicle speed up to 90 mph (145 km/h).
- When the driver releases the accelerator pedal in stabilised conditions or in deceleration.
- During the stop phases.

Restarting is only achieved by the belt starter until the torque demand is available, if the traction battery is sufficiently charged. When the torque demand is insufficient, the petrol engine restarts.

**i** Using the steering wheel paddles also causes the restarting of petrol engine.

**The e-Auto mode cannot switch off the petrol engine in the following cases:**

- The state of charge is less than 30% of the traction battery energy.
- There is a need for vacuum brake assist depending on the altitude.
- The Sport mode is selected.
- Maintaining thermal comfort in the passenger compartment (heating, air conditioning, demisting/defrosting).

## Deactivation/Reactivation

By default, the function is activated when the ignition is switched on.



It is configured in the **ADAS** touch screen application.

or

Direct access to the **Shortcuts for driving aids**.

The display of a message on the instrument panel confirms the change of state.



Function deactivated, this indicator lights up in the instrument panel.

**i** If high traction is required, the driver can deactivate the e-Auto mode using the touch screen application.

## Tyre under-inflation detection

This system alerts the driver if one or more tyres suffer a drop in pressure.

The alert is raised when the vehicle is moving, not when stationary.

It compares the information given by the wheel speed sensors with **reference values, which must be reinitialised every time the tyre pressures are adjusted or a wheel changed.** It takes into account the last values stored during the reinitialisation request. It is therefore essential that the tyre pressure is correct during the operation. This operation is the driver's responsibility.

**!** The tyre under-inflation detection cannot, in any circumstances, replace the need for vigilance on the part of the driver. This system does not avoid the need to regularly check the tyre pressures (including the spare wheel), especially before a long journey.

Driving with under-inflated tyres, particularly in adverse conditions (heavy load, high speed, long journey):

- worsens road-holding.
- lengthens braking distances.
- causes premature wear of the tyres.
- increases energy consumption.

**i** The inflation pressures defined for the vehicle can be found on the tyre pressure label.

For more information on the **Identification markings**, refer to the corresponding section.

### **!** Checking tyre pressures

This check should be done monthly when the tyres are "cold" (vehicle stopped for 1 hour or after a journey of less than 6 miles (10 km) at moderate speeds). Otherwise, add 0.3 bar to the pressures shown on the label.

### **i** Snow chains

The system does not have to be reinitialised after fitting or removing snow chains.

## Under-inflation alert



This is signalled by the fixed illumination of this warning lamp, accompanied by an

audible signal and, depending on equipment, the display of a message.

- ▶ Reduce speed immediately, avoid excessive steering movements and avoid sudden braking.
- ▶ Stop the vehicle as soon as it is safe to do so.

**!** The loss of pressure detected may not always cause visible deformation of the tyre. Do not rely on just a visual check.

- ▶ Using a compressor, such as the one in the temporary puncture repair kit, check the pressures of all four tyres when cold.
- ▶ If it is not possible to carry out this check immediately, drive carefully at reduced speed.
- ▶ In the event of a puncture, use the temporary puncture repair kit or the spare wheel (depending on equipment).

**!** Driving too slowly may not ensure optimum monitoring.

The alert is not immediately triggered in the event of a sudden loss of pressure or tyre blow-out. This is because analysis of the values read by the wheel's speed sensors can take several minutes.

The alert may be delayed at speeds below 25 mph (40 km/h), or when adopting a sporty driving mode.

**i** The alert is kept active until the system is reinitialised.



## Reinitialisation

The system must be reinitialised after any adjustment to the pressure of one or more tyres, and after changing one or more wheels.

**!** Before reinitialising the system, make sure that the pressures of the four tyres are correct for the conditions of use of the vehicle and conform to the values written on the tyre pressure label.

Check the pressures of the four tyres before performing the reinitialisation.

The system does not advise if a pressure is incorrect at the time of reinitialisation.



With the vehicle stationary, the system can be reinitialised in the

**Settings>Vehicle** touch screen application.

▶ Then select **Safety > Tire Pressure Setup**.

▶ Press **YES** to confirm.

The reinitialisation is confirmed by the display of a message and an audible signal.

## Malfunction



In the event of a malfunction, these warning lamps light up on the instrument panel.

A message appears, accompanied by an audible signal.

In this case, the tyre under-inflation monitoring function is no longer performed.

Have it checked by a PEUGEOT dealer or a qualified workshop.

### **i** Non-standard or 'space-saver' spare wheel

The use of this type of spare wheel may suspend tyre pressure monitoring. In this case, the malfunction warning lamp comes on and disappears once the wheel has been replaced by one of uniform size (the same as the others), the pressure readjusted and the reinitialisation carried out.

## Driving and manoeuvring aids - General recommendations

**i** Driving and manoeuvring aids cannot, in any circumstances, replace the need for vigilance on the part of the driver.

The driver must comply with the Highway Code, must remain in control of the vehicle in all circumstances and must be able to retake control of it at all times. The driver must adapt the speed to climatic conditions, traffic and the state of the road.

It is the driver's responsibility to constantly monitor traffic conditions, assess the distance and relative speed of other vehicles, and anticipate their manoeuvres before using the direction indicator and changing lanes.

These systems do not make it possible to exceed the laws of physics.

### **i** Driving aids

You should hold the steering wheel with both hands, always use the door and interior mirrors, always leave your feet close to the pedals and take a break every 2 hours.

### **i** Manoeuvring aids

The driver must always check the surroundings of the vehicle before and during the whole manoeuvre, in particular using the mirrors.

### **!** Radar(s)

The operation of the radar(s), along with any associated functions, may be affected by the accumulation of dirt (e.g. mud, ice), in poor weather conditions (e.g. heavy rain, snow), by the masking of the detection zone with adhesive labels or other objects, or if the bumpers are damaged.

If the front or rear bumper is to be repainted, contact a PEUGEOT dealer or a qualified workshop; certain types of paint could interfere with the operation of the radar(s). Take care not to cover the detection zones on the front and rear bumpers with adhesive labels or other objects; they may hamper correct operation of the associated system.



### **!** Driving aids camera

This camera and its associated functions may be impaired or not work if the windscreen area in front of the camera is dirty, misty, frosty, covered with snow, damaged or masked by a sticker.

In humid and cold weather, demist the windscreen regularly.

Poor visibility (e.g. inadequate street lighting, heavy rain, thick fog, snowfall), dazzle (e.g. headlamps of an oncoming vehicle, low sun, reflections on a damp road, leaving a tunnel, alternating shade and light) can also impair detection performance.

In the event of a windscreen replacement, contact a PEUGEOT dealer or a qualified workshop to recalibrate the camera; otherwise, the operation of the associated driving aids may be disrupted.

### **i** Other cameras

The images from the camera(s) displayed on the touch screen or on the instrument panel may be distorted by the terrain.

In the presence of areas in shade, or in conditions of bright sunlight or inadequate

lighting, the image may be darkened and with lower contrast.

Obstacles may appear further away than they actually are.

### **!** Sensors

The operation of the sensors, as well as any associated functions, may be disrupted by noise pollution such as that emitted by noisy vehicles and machinery (e.g. lorries, pneumatic drills), by the accumulation of snow or dead leaves on the road or in the event of damaged bumpers and mirrors.

When reverse gear is engaged, an audible signal (long beep) indicates that the sensors may be dirty.

A front or rear impact to the vehicle can upset the sensors' settings, which is not always detected by the system: distance measurements may be distorted.

The sensors do not systematically detect obstacles that are too low (pavements, studs) or too thin (trees, posts, wire fences). Certain obstacles located in the sensors' blind spots may not be detected or may no longer be detected during the manoeuvre.

Certain materials (fabrics) absorb sound waves: pedestrians may not be detected.

### **i** Maintenance

Clean the bumpers and door mirrors and the field of vision of the cameras regularly.

When washing your vehicle at high pressure, direct the spray from at least 30 cm away from the radar, sensors and cameras.

### **!** Mats/Pedal trims

The use of mats or pedal trims not approved by PEUGEOT may interfere with the operation of the speed limiter or cruise control.

To avoid any risk of jamming the pedals:

- Ensure that the mat is secured correctly.
- Never fit one mat on top of another.

### **i** Units of speed

Ensure that the units of speed displayed on the instrument panel (mph or km/h) are those for the country you are driving in. If this is not the case, when the vehicle is stationary, set the display to the required units of speed so that it complies with what is authorised locally.

In case of doubt, contact a PEUGEOT dealer or a qualified workshop.

## Steering wheel with hands-on detection

(with Drive Assist 2.0)

**!** For more information, refer to the **General recommendations on the use of driving and manoeuvring aids.**

The steering wheel is equipped with a hands-on detection system to avoid distraction on the part of the driver.

It is prohibited to cover or attach anything to the steering wheel.

**!** The driver must always check the surroundings of the vehicle and supervise the whole manoeuvre. Any use of a system built into Drive Assist 2.0 must remain under the driver's vigilance. The system also detects the presence of hands when using the Lane Positioning assist system with Drive Assist Plus.

**i** The system may suffer interference or not work correctly if:

- the steering wheel is covered by some protection.
- the driver wears thick gloves (e.g. ski gloves).

In the event of improper detection of hands on the steering wheel, Drive Assist 2.0 is

not activated or is deactivated after a few seconds.

**!** Installation of mechanical anti-theft devices on the steering wheel is prohibited - risk of damage!

## Shortcuts for driving aids

The full list of available driving aids can be found in the **Functions** tab.

Driving aids can be accessed directly to quickly activate/deactivate them.

By default, driving aids are already stored in the **Shortcuts** tab (e.g. Stop & Start, Lane Keeping assist).

Other driving aids can be added or deleted from this tab.



It is configured in the **ADAS>Functions** touch screen application.

▶ Press the button corresponding to the driving assistance concerned:

- Full symbol: the function is added to the **Shortcuts** tab.
  - Empty symbol: the function is deleted from the **Shortcuts** tab.
- ▶ Check the modification in the **Shortcuts** tab.

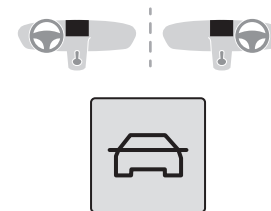

▶ Press this button to access directly to the **Shortcuts** tab.

## Multiple deactivation

It is possible to deactivate several driver assistance functions simultaneously.

This is done in two steps:

- First of all, the selection of all the functions that you want to deactivate.
- Secondly, the simultaneous deactivation of all these functions.

### Selection of functions



▶ Press this button on the dashboard to display the **ADAS** tabs.

▶ Select the **Functions** tab.





▶ Press this button to display the list of available functions.

▶ Select the functions that will be deactivated by a long press on the **ADAS** button at each start (e.g. Stop-Start, Lane Keeping Assist, Automatic Braking System (Active Safety Brake)).

 ▶ Press this button to return to the previous page.

The functions to deactivate are saved in the system.

### Deactivation of these functions

  ▶ Press and hold this button on the dashboard.

All previously selected functions are deactivated until the vehicle is next restarted (confirmed by an audible signal).

## Road signs recognition

 For more information, refer to the **General recommendations on the use of driving and manoeuvring aids.**

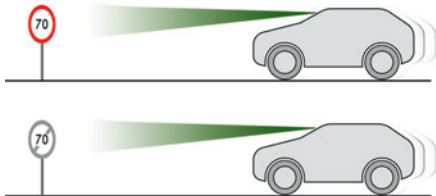



This system displays the maximum speed authorised locally on the instrument panel, using:



- Speed limit signs detected by the camera.
- Speed limit information from the on-board navigation system's mapping.

- Speed limit information from the connected services.
- Signs indicating a shared traffic zone detected by the camera.

Sign detected	Suggested speed (calculated)
<b>Entry into a shared traffic zone</b> Example: 	<b>Without PEUGEOT i-Connect Advanced</b> 10 mph or 20 km/h (depending on the units on the instrument panel) <b>With PEUGEOT i-Connect Advanced</b> Display of the speed in force in the country you are driving in.

- Some supplementary traffic signs detected by the camera.

Supplementary traffic sign detected	Display of the speed associated with the supplementary traffic sign
<b>Speed limit when raining</b> Examples: 	If the wiper control stalk is in the "intermittent wipe" or "automatic wipe" position (in order to activate the rain sensor): 68 mph (110 km/h) (for example)
<b>Speed limit when towing</b> 	If an approved towing device is fixed to the vehicle: 56 mph (90 km/h) (for example)
<b>Speed limit applicable over a certain distance</b> Example: 	43 mph (70 km/h) (for example)

Supplementary traffic sign detected	Display of the speed associated with the supplementary traffic sign
<p><b>Speed limit for vehicles with a gross vehicle weight or gross train weight less than 3.5 tonnes</b></p> 	56 mph (90 km/h) (for example)
<p><b>Speed limit in case of snow</b> Example:</p> 	<p>If the outside temperature is below 3°C: 19 mph (30 km/h) (for example) with a "snowflake" symbol</p>
<p><b>Speed limit at certain times of the day</b> Example:</p> 	19 mph (30 km/h) (for example) with a "clock" symbol

**i** To get valid speed limit information, the vehicle's current position is sent via the

telematics unit and is immediately deleted after processing.  
Tracking of the vehicle position is not possible at any time.  
This is not impacted by the privacy settings of the connected services.

**!** On-board navigation mapping should be regularly updated in order to receive accurate speed limit information from the system.

**!** The units for the speed limit (mph or km/h) depend on the country you are driving in.  
This should be taken into account to ensure you observe the speed limit.  
For the system to work properly when changing countries, the speed unit of the instrument panel must match that of the country you are driving in.  
Country selection is only available for audio systems without on-board navigation.

**!** Automatic sign reading is a driving aid system and does not always display the correct speed limits.  
The speed limit signs present on the road always take priority over those displayed by the system.

The system is designed to detect signs that conform to the Vienna Convention on road signs.

**i** Specific speed limits, such as those for heavy goods vehicles, are not displayed.  
The display of the speed limit on the instrument panel is updated when passing a speed limit sign intended for cars (light vehicles).

## Information displayed on the instrument panel



1. Detected speed limit indication  
or
2. End of speed limit indication



The system is active but is not detecting speed limit information.



On detecting speed limit information, the system displays the value, accompanied by an audible signal.



For a suggested maximum speed, when the vehicle exceeds it, the speed is displayed and flashes for 3 seconds.



If the vehicle continues to exceed it, the speed is displayed and flashes for 8 seconds, accompanied by an audible signal.

## Operating limits

The system does not take account of reduced speed limits, especially those imposed in the following cases:

- Atmospheric pollution.
- Towing.
- Driving with a space-saver type spare wheel or snow chains fitted.
- Tyre repaired using the temporary puncture repair kit.
- Young drivers.

The system may not display the speed limit if it does not detect a speed limit sign within a preset period and in the following situations:

- Non-standard road signs.
- Road signs that are obstructed, damaged or bent.

## Settings

### Deactivation/Activation

By default, the overspeed alert sound is automatically activated at every engine start.



You can activate/deactivate the overspeed alert and the speed limit change sound.

or

Direct access to the **Shortcuts for driving aids**.



The system cannot be deactivated. The speed limit change sound is saved when the ignition is switched off.



In the event of the overspeed alert sound deactivation, this warning lamp lights up a few seconds on the instrument panel.

### Country selection

The list of detected road signs can be updated by selecting a specific country.



► In the **ADAS** touch screen application, select **Functions>Road Signs>Country setting**.

► In the **Select Country** list, select the desired country.



The current country is displayed under the function name in the settings screen. The country selection is saved when the ignition is switched off.

## Malfunction



In the event of a malfunction, this warning lamp lights up on the instrument panel, accompanied by the display of a message and an audible signal.

Have it checked by a PEUGEOT dealer or a qualified workshop.



This warning lamp lights up on the instrument panel with the message **"Driving Assistance Sensor blind: Clean sensor, see User Manual"** if the sensor is masked.

This is a normal behavior, which does not request the support of a qualified workshop. In this case, stop the vehicle and verify if the front camera is covered by dirt, mud, sand, snow, ice or anything preventing the sensing. The system is operational again after the detection field has been cleaned.

## Speed setting recommendations

The driver can select the speed displayed by the **Road signs recognition** system as the speed setting for the speed limiter, cruise control or adaptive cruise control using the **OK** button.

If rain is detected, the system proposes a speed setting to the driver which is lower than the speed read/sent from the mapping system in order to adapt to the weather conditions (e.g. on motorways, the proposed speed is 68 mph (110 km/h) instead of 81 mph (130 km/h)).

**i** For more information on the **Speed limiter**, **Cruise control** or **Adaptive cruise control**, refer to the corresponding sections.

### Speed setting advance recommendations

With Drive Assist 2.0 activated, the system detects the next speed limit sign, displays it in the background and proposes this new speed as the speed setting.

Once memorised:

- If the speed setting is lower than the previous one, the vehicle slows down to reach this new speed when it gets to the sign.
- If the speed setting is higher than the previous one, the vehicle speeds up to reach this new speed when it passes the sign.

### Steering-mounted controls

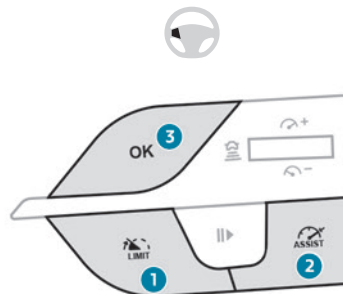

1. Select speed limiter mode
2. Select cruise control mode
3. Memorise the speed setting

### Information displayed on the instrument panel

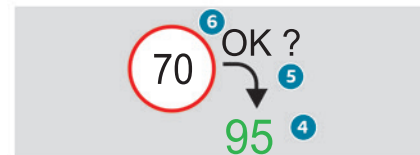
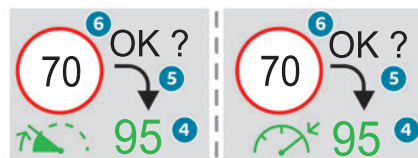

Without speed setting advance recommendation

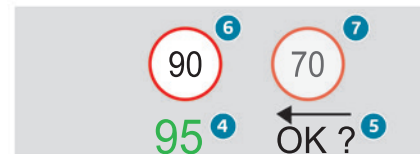

With speed setting advance recommendation

4. Current speed setting
5. Speed memorisation prompt
6. Current speed limit indication
7. Next speed limit indication

### Operating conditions

- Eligible roads: roads with separate carriageways with prohibited access for pedestrians and cyclists.
- Drive Assist 2.0 activated.
- Vehicle speed between 0 and 112 mph (0 and 180 km/h).
- Steering wheel properly held by the driver.

## Memorising the speed setting

- Switch on the speed limiter **1-LIMIT** or cruise control **2**.

Information related to the speed limiter or cruise control is displayed.

When a new speed setting is detected, the system displays the value and **"OK?"** to suggest saving it as a new speed setting.

**i** If there is a difference of less than 3 mph (5 km/h) between the speed setting and the speed displayed by the Road signs recognition, the **"OK?"** symbol is not displayed.

Depending on the road conditions, several speeds may be displayed.

- Press **3-OK** to confirm the new speed setting. The display then reverts to its previous state.

## Extended Traffic Sign Recognition

**!** For more information, refer to the **General recommendations on the use of driving and manoeuvring aids.**



This additional system recognises these road signs and displays them on the instrument panel.

As you approach it, the symbol of the corresponding sign is displayed on the instrument panel.

The selected display mode must be **"Driving"**.

**!** The actual road signs always take priority over those displayed by the system. The signs must comply with the Vienna Convention on road signs.

## Activation/Deactivation



It is configured in the **ADAS** touch screen application.

## Speed limiter

**!** For more information, refer to the **General recommendations on the use of driving and manoeuvring aids.**



This system prevents the vehicle from exceeding the speed programmed by the driver (speed setting).

The speed limiter is switched on manually. The minimum speed setting is 19 mph (30 km/h). The speed setting remains in the system memory when the ignition is switched off.

## Steering-mounted controls

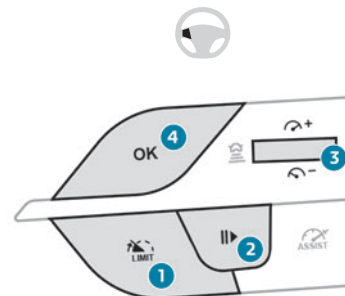

1. Speed limiter selection
2. Switch on/pause the speed limiter at the previously saved speed setting
3. Increase/Decrease the speed setting
4. Activate the speed limiter at the previously saved speed setting  
Use the speed suggested by the Road signs recognition function

For more information on the **Road signs recognition** function, refer to the corresponding section.



## Information displayed on the instrument panel

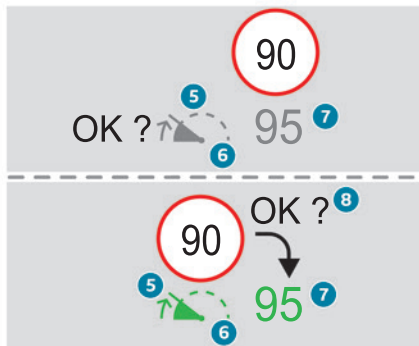

5. Speed limiter mode selection indication
6. Speed limiter on (green)/pause (grey) indication
7. Speed setting value
8. Speed suggested by the Road signs recognition function (depending on version)

## Switching on/Pausing

- ▶ Press **1-LIMIT** to select the speed limiter mode; the function is paused (grey).
- ▶ If the limit speed setting is suitable (most recent speed setting programmed in the system), press **2-I** ▶ or **4-OK** to switch the speed limiter on (green).
- ▶ Pressing **2-I** ▶ again temporarily pauses the function.

**i** When the speed setting remains below the vehicle's speed for a prolonged period of time, an audible warning is emitted.

## Adjusting the speed setting

You do not have to switch the speed limiter on in order to set the speed.

To change the speed setting using the vehicle's current speed:

- ▶ For steps of +/- 1 mph (1 km/h), make successive short presses upwards/downwards on **3** to increase/decrease.
- ▶ For steps of +/- 5 mph (5 km/h), press and hold upwards/downwards on **3** to increase/decrease.

When the function is activated, the limit speed value can be changed using the speed suggested by the Road signs recognition function displayed on the instrument panel:

- **When passing the sign:**
  - ▶ Press **4-OK** to save the suggested speed. This value is then immediately shown as the new speed setting on the instrument panel.
- **After passing the sign:**
  - ▶ Press **4-OK**. The message "OK?" is displayed to confirm the request to save.
  - ▶ Press **4-OK** again to save the suggested speed. The new speed setting value is displayed on the instrument panel.

## Temporarily exceeding the speed setting

- ▶ Fully depress the accelerator pedal. The speed limiter is temporarily deactivated and the displayed speed setting flashes.

- ▶ Release the accelerator pedal to return to below the speed setting.

When exceeding the speed is not due to the driver's action (e.g. in case of a steep slope), an audible signal is triggered immediately.

**!** On a steep descent or in the event of sharp acceleration, the speed limiter will not be able to prevent the vehicle from exceeding the speed setting. If necessary, apply the brakes to control your vehicle's speed.

When the vehicle speed returns to the speed setting level, the speed limiter operates again: the speed setting display becomes fixed again.

## Off

- ▶ Press **1-LIMIT**: the speed limiter information display disappears.

## Malfunction

In the event of a malfunction, dashes are displayed flashing and then fixed instead of the speed setting.

Have it checked by a PEUGEOT dealer or a qualified workshop.

## Cruise control - Specific recommendations

**!** The cruise control function does not guarantee compliance with the maximum authorised speed and the safety distance between vehicles, the driver remains responsible for their driving.

In the interest of public safety, only use cruise control if the traffic conditions enable vehicles to drive at a steady speed and maintain an adequate safety distance.

**Remain vigilant while cruise control is activated.** If you press and hold one of the speed setting modification buttons, your vehicle may change speed very abruptly. When **descending a steep hill**, the cruise control system cannot prevent the vehicle from exceeding the set speed. Brake if necessary to control the vehicle speed. On **steep climbs** or when towing, the set speed may not be reached or maintained.

### **i** Exceeding the programmed speed setting

You can **temporarily** exceed the speed setting by pressing the accelerator pedal (the programmed speed flashes).

To return to the speed setting, release the accelerator pedal (when the set speed is reached again, the displayed speed stops flashing).

### **!** Operating limits

Never use the system in the following situations:

- In an urban area with the risk of pedestrians crossing the road.
- In heavy traffic (except versions with the Stop & Go function).
- On winding or steep roads.
- On slippery or flooded roads.
- In poor weather conditions.
- In the event of restricted visibility for the driver.
- Driving on a speed circuit.
- Driving on a rolling road.
- When using a 'space-saver' type spare wheel.
- When using snow chains or non-slip covers.

## Cruise control

**!** For more information, refer to the **General recommendations on the use of driving and manoeuvring aids** and the **Specific recommendations on cruise control**.



This system automatically maintains the vehicle's speed at the value programmed by the driver (speed setting), without the use of the accelerator pedal.

Cruise control is switched on manually.

It requires a minimum vehicle speed of 25 mph (40 km/h).

With a manual gearbox, whichever gear is engaged.

With an automatic gearbox, mode **D** or second gear or higher in mode **M** must be engaged.

With a drive selector, mode **D** or **B** must be engaged.

**i** Cruise control remains active after changing gear, regardless of the gearbox type, on engines fitted with the Stop & Start function.

**i** Switching off the ignition cancels any speed setting.

## Steering-mounted controls

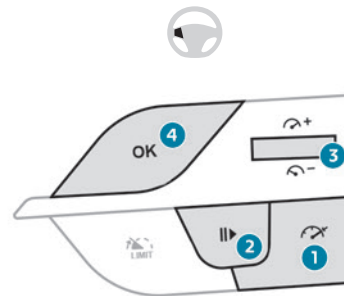

1. Cruise control selection

2. Switch on/pause cruise control at the previously saved speed setting
3. Increase/Decrease the speed setting (if cruise control activated)  
Activation of cruise control in progress (if cruise control deactivated)
4. Activation of cruise control in progress  
Use the speed suggested by the Road signs recognition

For more information on the **Road signs recognition** function, refer to the corresponding section.

## Information displayed on the instrument panel

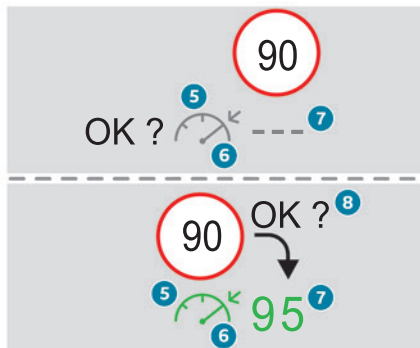

5. Cruise control mode selection indication

6. Cruise control on (green)/pause (grey) indication
7. Speed setting value
8. Speed suggested by the Road signs recognition function (depending on version)

## Switching on/pausing

- ▶ Press button **1** to select the cruise control mode; the function is paused (grey).
- ▶ Press **3** upwards/downwards, or press **4-OK** to activate the cruise control and save a speed setting as soon as the vehicle speed reaches the desired level (green).
- ▶ Pressing button **2-I I>** temporarily pauses the function.
- ▶ Pressing **2-I I>**, **3** or **4-OK** again will reactivate cruise control (green).

- i** Cruise control operation is also temporarily interrupted (pause):
  - by pressing the brake pedal.
  - automatically, if the electronic stability control (ESC) system is triggered.
  - by shifting to neutral or engaging reverse gear.
  - by depressing the clutch pedal for more than 5 seconds.
  - by using the electric parking brake.

## Modifying the speed setting

The cruise control must be active.

To change the speed setting using the vehicle's current speed:

- ▶ For steps of +/- 1 mph (1 km/h), make successive short presses upwards/downwards on **3** to increase/decrease.
- ▶ For steps of +/- 5 mph (5 km/h), press and hold upwards/downwards on **3** to increase/decrease.

**!** Prolonged pressing and holding upwards/downwards on **3** causes a very rapid change in vehicle speed.

**!** As a precaution, we recommend setting a cruise speed fairly close to the current speed of your vehicle, to avoid any sudden acceleration or deceleration of the vehicle.

When the function is activated, the speed setting value can be changed using the speed suggested by the Road signs recognition function displayed on the instrument panel:

– **When passing the sign:**

- ▶ Press **4-OK** to save the suggested speed. This value is then immediately shown as the new speed setting on the instrument panel.

– **After passing the sign:**

- ▶ Press **4-OK**. The message "OK?" is displayed to confirm the request to save.
- ▶ Press **4-OK** again to save the suggested speed. The new speed setting value is displayed on the instrument panel.

## Off

► Press 1: the cruise control information display disappears.

## Malfunction

In the event of a malfunction, dashes are displayed flashing and then fixed instead of the speed setting.

Have it checked by a PEUGEOT dealer or a qualified workshop.

## Drive Assist Plus

Only available on versions with automatic gearbox and drive selector.

This system automatically adjusts the speed and corrects the trajectory of the vehicle, using Adaptive cruise control with Stop&Go function in conjunction with Lane positioning assist.

These two functions must be activated and in operation.

For more information on **Adaptive cruise control** and **Lane positioning assist**, refer to the corresponding sections.

**!** The system assists the driver by acting on the steering, acceleration and braking within the physical limits and capacities of the vehicle. Certain road infrastructure elements or vehicles in the surroundings may not be properly seen or may be poorly interpreted by the camera and radar, resulting in an unexpected change in direction, a lack of

steering correction and/or inappropriate management of acceleration or braking.

**!** Primarily designed for driving on main roads and motorways, this system only works with moving vehicles driving in the same direction as your vehicle.

## Selecting/Deselecting the system



► Press this button successively until the Drive Assist Plus mode is displayed on the instrument panel.

► After a few seconds, the Drive Assist Plus mode is selected. The Driving aids mini-view is displayed on the instrument panel.



The colour of the symbols, representing the steering wheel and the side lines, depends on the operating state of the system:



(grey)

One or more operating conditions is not met; the system is paused.



(green)

All operating conditions are met; the system is active.



(orange)

System malfunction.

► Press this button successively again until the OFF mode is displayed on the instrument panel.

► After a few seconds, the Drive Assist Plus mode is deselected. The Driving aids mini-view disappears.

## Drive Assist 2.0

This system automatically regulates the speed and corrects the trajectory of the vehicle by combining the following functions:

- Drive Assist Plus with Adaptive cruise control with Stop&Go function and Lane positioning assist.
- Semi-automatic lane changing.
- Speed setting advance recommendation.

For more information on these functions, refer to the corresponding sections.

The availability of the system depends on the country you are driving in.

This system is only to be used on eligible motorways and main roads.

## Selecting/Deselecting the system



It is configured in the **ADAS** touch screen application.

► Select the **Functions** tab, then select/deselect **Drive Assist**.

The system's status is saved when the ignition is switched off.

## Adaptive cruise control

! For more information, refer to the **General recommendations on the use of driving and manoeuvring aids** and the **Specific recommendations on cruise control**.

This system automatically maintains the vehicle speed at a value set by the driver (speed setting), while respecting a safety distance from the vehicle in front (target vehicle) previously set by the driver. The system automatically manages the acceleration and deceleration of the vehicle. With a manual gearbox, the system slows the vehicle down as far as a speed of 19 mph (30 km/h).

With the **Stop & Go function**, the system manages braking until the vehicle comes to a complete stop and restarts the vehicle.

! The brake lamps come on if the vehicle is slowed down by the system. The system is not operational in the event of a brake lamp failure.



To do this, the system uses a camera fitted at the top of the windscreen and, depending on version, a radar fitted in the front bumper.

! Primarily designed for driving on main roads and motorways, this system only works with moving vehicles driving in the same direction as your vehicle.

i If the driver activates the direction indicator to overtake a slower vehicle, cruise control may temporarily reduce the distance to the target vehicle to facilitate overtaking, without exceeding the speed setting.

## Steering-mounted controls

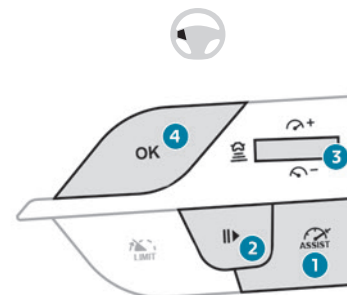

1. Selection/deselection of cruise control only or Drive Assist Plus (depending on version)
2. Switch on/pause cruise control at the previously saved speed setting  
Confirmation of vehicle restart after automatic stop (version with Stop & Go function)
3. Increase/Decrease the speed setting (if cruise control activated)  
Activation of cruise control in progress (if cruise control deactivated)  
Display and configuration of the inter-vehicle distance setting
4. Activation of cruise control in progress  
Use the speed suggested by the Road signs recognition function

For more information on the **Road signs recognition** function, refer to the corresponding section.

## Information displayed on the instrument panel

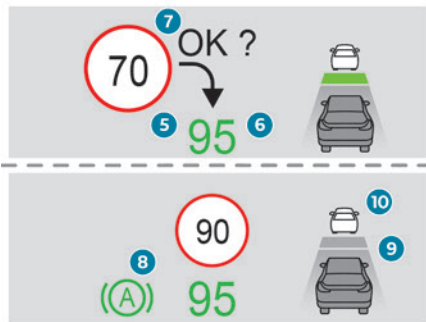

5. Cruise control activated (green)/paused (grey)
6. Speed setting value
7. Speed suggested by the Road signs recognition function
8. Vehicle held stationary (version with Stop&Go function)
9. Inter-vehicle distance setting
10. Position of the vehicle detected by the system

## Use

### Selecting the system

- ▶ With the engine running, press successively on **1-ASSIST** until cruise control mode is displayed on the instrument panel.

- ▶ After a few seconds, cruise control mode is selected. The Driving aids mini-view is displayed (grey) and cruise control is ready to be activated.

### Switching on cruise control

With a manual gearbox, your speed must be between 19 and 112 mph (30 and 180 km/h). With an automatic gearbox or a drive selector, your speed must be between 0 and 112 mph (0 and 180 km/h).

System activation is also subject to the following conditions:

- Driver's door closed.
- Driver's seat belt fastened.
- Second gear or higher engaged on the manual gearbox.
- Mode **D** selected on the automatic gearbox.
- Parking brake released.
- If the vehicle is stationary, brake pedal depressed.

A message **OK?** is displayed if all activation conditions are met.

- ▶ Press **4-OK**: the current speed becomes the speed setting (minimum 19 mph (30 km/h)) and cruise control is immediately activated (green display).

### Modifying the speed setting

To change the speed setting using the vehicle's current speed:

- ▶ For steps of +/- 1 mph (1 km/h), make successive short presses upwards/downwards on **3** to increase/decrease.

- ▶ For steps of +/- 5 mph (5 km/h), press and hold upwards/downwards on **3** to increase/decrease.

**!** Prolonged pressing and holding upwards/downwards on **3** causes a rapid change in vehicle speed.

When the function is activated, the speed setting value can be changed using the speed suggested by the Road signs recognition function displayed on the instrument panel:

#### – When passing the sign:

- ▶ Press **4-OK** to save the suggested speed. This value is then immediately shown as the new speed setting on the instrument panel.

#### – After passing the sign:

- ▶ Press **4-OK**. The message "OK?" is displayed to confirm the request to save.
- ▶ Press **4-OK** again to save the suggested speed. The new speed setting value is displayed on the instrument panel.

### Pausing/Resumption of cruise control

- ▶ Press **2-II>** or depress the **brake pedal**.

The symbol "II>" is displayed if all activation conditions are met.

Cruise control may also have been paused:

- automatically, if the electronic stability control (ESC) system is triggered.
- by shifting to neutral or engaging reverse gear.
- when the speed of the vehicle goes below 19 mph (30 km/h) with a manual gearbox.

- when a risk of engine stalling is detected with a manual gearbox.
  - by depressing the clutch pedal for more than 10 seconds.
  - by using the electric parking brake.
  - by unfastening the seat belt.
  - by opening the driver's door.
- ▶ Press **2-||>** or **4-OK** to reactivate cruise control.

With a manual gearbox, the driver should depress the accelerator pedal to move off, then, when above 19 mph (30 km/h), reactivate the system by pressing **2-||>** or **4-OK**.

With an automatic gearbox or a drive selector, following braking that has brought the vehicle to a complete stop, if the traffic conditions do not allow the vehicle to begin moving again within 3 seconds of stopping, press **2-||>** or the accelerator pedal to move off.

**i** Cruise control remains active after changing gear, regardless of the gearbox type.

**!** When cruise control is paused and the driver tries to reactivate it, the message "**Activation not possible, conditions not met**" is temporarily displayed if reactivation is impossible (required conditions not met).

### Changing the programmed speed setting with the Road signs recognition function

▶ Press **4-OK** to accept the speed suggested by the function on the instrument panel, then press again to confirm.

**!** If the selected speed is far from the current vehicle speed, a strong acceleration or deceleration is felt.

### Changing the inter-vehicle distance

▶ Press **3** to display the distance setting thresholds ("**Distant**", "**Normal**" or "**Close**"), then make successive short presses upwards/downwards to select a threshold.

After a few seconds, the option is accepted and will be memorised when the ignition is switched off.

The driver must keep a sufficient safety distance from the vehicle in front.

### Temporarily exceeding the speed setting

▶ Depress the accelerator pedal. The system is suspended as long as the acceleration is maintained. When the accelerator pedal is released, the speed setting flashes while the current vehicle speed is above the speed setting.

### Deselecting the system

▶ Press successively on **1-ASSIST** until **OFF** mode is displayed on the instrument panel.

▶ After a few seconds, cruise control mode is deselected. The Driving aids mini-view disappears.

## Messages and alerts

**i** The actual order of display of the messages or alerts may be different.

**90**  Cruise control selected, but cannot be activated. All the operating conditions have not been met.

(grey) **90**  Cruise control selected, awaiting confirmation for activation. All the operating conditions are met.

(grey) **90**  Cruise control paused, but cannot be reactivated. All the operating conditions have not been met.

(grey)/(grey) **90**  Cruise control paused, awaiting confirmation for reactivation. All the operating conditions are met.

(grey)/(grey) **90**  Cruise control active, vehicle detected.

(green)/(green)



Cruise control suspended, following brief acceleration by the driver.

(green)/(grey)



(orange)  
"Take back control"

► Brake or accelerate, depending on the context.



(red)  
"Take back control"

► **Take back control of the vehicle immediately:** the system cannot manage the current driving situation.



"Activation refused, conditions unsuitable"

The system refuses to activate cruise control, as the necessary conditions are not fulfilled.

### Stop & Go function



The system has brought the vehicle to a complete stop.

(green)/(green)

Within 3 seconds of stopping, the vehicle gradually and automatically begins moving again.

Beyond 3 seconds of stopping, the driver must accelerate or press **2-II>** to move off.

**i** If the driver takes no action after the vehicle has been stopped, the electric parking brake is applied automatically after about 5 minutes.

**!** While the vehicle is immobilised, the following recommendations apply:

- The driver should not leave the vehicle.
- Do not open the boot.
- Do not drop off or pick up passengers.
- Do not engage reverse gear.

**!** When restarting the vehicle, beware of cyclists, pedestrians or animals who are not taken into account by the system. The driver must monitor their surroundings.

## Operating limits

Cruise control operates by day and night, in dry weather or moderate rainfall.

Certain situations cannot be managed by the system and require driver intervention.

**Cases not taken into account by the system:**

- Pedestrians, cyclists, animals.
- Stationary vehicles (e.g. traffic jams, breakdown).

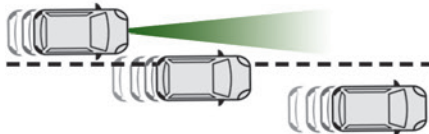

- Vehicles crossing your lane.
- Vehicles driving in the opposite direction.

**Situations where the driver must suspend the system:**

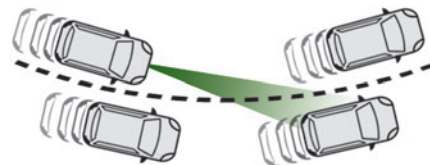

- Vehicles in a tight bend.
- When approaching a roundabout.

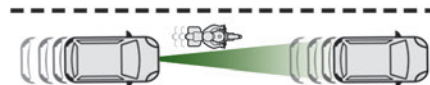

- When following a narrow vehicle.  
Reactivate the system when conditions allow.  
**Situations in which the driver is prompted to immediately resume control:**

- Excessively sharp deceleration by the vehicle in front of you.

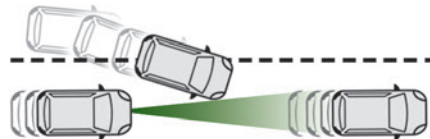

- When a vehicle cuts in sharply between your vehicle and the one in front.

**!** Some vehicles on the road may be poorly perceived or interpreted by the camera and/or the radar (e.g. truck), which



can lead to an incorrect evaluation of distances and result in inappropriate acceleration or braking of the vehicle.

- !** Pay particular attention:
- When motorcycles are present and when there are vehicles staggered across the traffic lane.
  - When entering a tunnel or crossing a bridge.

- !** If any of the following malfunctions occurs, do not use the system:
- Following an impact on the windscreen close to the camera or on the front bumper.
  - If a brake lamp is not working.

- !** If the vehicle has undergone any of the following modifications, do not use the system:
- Carrying long objects on roof bars.
  - Towing.
  - Front end of the vehicle modified (for example by adding long-range headlamps or painting the front bumper).
  - Obstructed radar and/or camera.

## Malfunction

In the event of a malfunction, dashes are displayed (orange) instead of the speed setting.



This warning lamp comes on, accompanied by a message and an audible signal, to confirm the malfunction. Have it checked by a PEUGEOT dealer or a qualified workshop.

## Lane positioning assist

- !** For more information, refer to the **General recommendations on the use of driving and manoeuvring aids.**

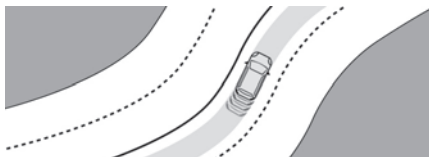

The system identifies the edges of the traffic lane and steers the vehicle to keep it inside this lane and maintain the lateral position chosen by the driver.

To do this, the system uses a camera placed on the upper part of the windscreen. This system is particularly suited to driving on motorways and main roads.

## Activation/Deactivation

The Lane positioning assist system is automatically activated, after selecting Drive Assist Plus mode.

For more information on the **Drive Assist Plus** system, refer to the corresponding section. The selection is confirmed by the display of the symbols on the instrument panel, representing the steering wheel and the side lines. The colour of the symbols depends on the operating state of the system:



(grey)

One or more operating conditions is not met; the system is paused.



(green)

All operating conditions are met; the system is active.



(orange)

System malfunction.

If the driver no longer wishes to use the system for some time, they can deactivate it by pressing the **ASSIST** button again (confirmed by the Driving aids mini-view disappearing from the instrument panel).



The system status is saved when the ignition is switched off.

## Operating conditions

- Adaptive cruise control active.
- ESC system operational.
- ASR system activated.
- No trailer detected.
- No 'space-saver' spare wheel in use.
- Vehicle not subject to strong lateral acceleration.

- Direction indicators off upon activation of the system.

## Regulation

### The driver must hold the steering wheel properly.

When regulation is activated, the symbols are displayed in green: with small steering inputs, the system steers the vehicle and keeps it in the position chosen by the driver in the traffic lane. This position is not necessarily the centre of the lane.

The driver can feel movements in the steering wheel.

At any time, the driver can change the position of the vehicle by intervening on the steering wheel and maintaining the position until the system has taken it into account. If the chosen position is too off-centre, an automatic re-centering manoeuvre can occur. The system adjusts to the newly defined position.

## Pausing/Suspending the system

**!** The driver must act promptly if they believe that the traffic conditions or the state of the road surface require their intervention, by moving the steering wheel to temporarily suspend system operation. Any action on the brake pedal that causes the Adaptive cruise control system to be paused will also cause the system to be paused.

**!** If the system detects that the driver is not holding the wheel firmly enough, it triggers a series of gradual alerts and then deactivates itself if there is no response from the driver.

**i** If the function is suspended due to the prolonged release of the force holding the steering wheel, the system must be

reactivated by pressing the **ASSIST** button again.

### Automatic suspension

Suspension of the system is accompanied by a specific audible signal.

- Triggering of the ESC system.
- Insufficient lane detection. In this case, the Lane keeping assist function can take over, and the system will reactivate itself once the operating conditions are met again.





### Paused by the driver

- Travelling outside the lane limits.
- Too tight a grip on the steering wheel or dynamic action on the steering wheel.
- Action on the brake pedal (resulting in a pause until cruise control is reactivated) or accelerator pedal (suspension for as long as the pedal is depressed).
- Pausing of the Adaptive cruise control system.
- Deactivation of the ASR system.

## Driving situations and related alerts

The tables below describe the displays associated with the main driving situations. The actual order of display of these alerts may be different.

Steering wheel-mounted controls	Symbols	Comments
<b>ASSIST or II&gt;</b>	 (grey)/(grey)	Cruise control paused. Drive Assist Plus switched off.

Steering wheel-mounted controls	Symbols	Comments
ASSIST or OK	 (green) /(green)	Cruise control on. Drive Assist Plus switched off.
ASSIST	 (green)/(green)	Drive Assist Plus activated. Lane positioning assist operates normally (presence of steering wheel correction).
II>	 (grey) /(grey)	Drive Assist Plus paused by the driver.
ASSIST or OK	 (green)/(grey)	Drive Assist Plus on standby. All the operating conditions for lane positioning assist have not been met.
ASSIST or II>	 (grey)/(grey)	Drive Assist Plus suspended. Cruise control and lane positioning assist are suspended.

Messages	Driving situations
"Keep your hands on the steering wheel" (framed in blue)	Prolonged driving without holding the steering wheel, holding it improperly or without applying any force.
"Hold steering wheel" (framed in orange)	Actual or imminent loss of lane positioning assist.

Messages	Driving situations
"Hold steering wheel" (framed in red)	Simultaneous loss of cruise control and lane positioning assist.

## Operating limits

**I** The system may issue an alert when the vehicle is travelling on a long, straight road with smooth road surface even if the driver thinks they are holding the steering wheel correctly.

The system may not operate or may produce unsuitable corrections to the steering in the following situations:

- Wearing thick gloves (with Drive Assist 2.0).
- Poor visibility (insufficient road lighting, snowfall, rain, fog).
- Dazzle (headlamps of an oncoming vehicle, low sun, reflections on a wet road surface, leaving a tunnel, alternating light and shade).
- Windscreen area in front of the camera dirty, misted up, frost-covered, snow-covered, damaged or covered by a sticker.
- Lane markings eroded, partially hidden (snow, mud) or multiple (roadworks, surface joints).
- Travelling in a tight bend.
- Winding roads.
- Road surface repairs.

## Risk of undesirable operation

- !** The system should be deactivated in the following situations:
- When changing a wheel or working near a wheel.
  - Towing or with a bicycle carrier on a towing device, especially with trailer not plugged in or not approved.
  - Adverse weather conditions.
  - Road with low grip (risk of aquaplaning, snow, ice).
  - Road works and toll areas.
  - Driving on racing circuits.
  - Driving on a rolling road.

## Malfunction



In the event of a malfunction, the Service warning lamp comes on and this (orange) symbol appears on the instrument panel, accompanied by the display of a message and an audible signal. Have it checked by a PEUGEOT dealer or a qualified workshop.

## Semi-automatic lane changing

(with Drive Assist 2.0)

**!** For more information, refer to the **General recommendations on the use of driving and manoeuvring aids.**

This system assists the driver in changing lanes. To do this, it uses the camera located at the top of the windscreen, the radar located at the front and the four angle radars fitted in the bumpers.

**!** The steering wheel is equipped with a hands-on detection system to avoid distraction on the part of the driver. For more information on the **Hands-on detection**, refer to the corresponding section.

**!** The system cannot in any circumstances replace the need for vigilance on the part of the driver. The driver remains responsible for their driving by monitoring their surroundings and keeping their hands on the steering wheel. The driver must act promptly if they believe that the traffic conditions or the state of the

road surface require their intervention, by moving the steering wheel to temporarily suspend system operation. Any intervention on the brake pedal or the accelerator pedal that causes the adaptive cruise control to be paused or suspended will also cause the system to deactivate.

## Selecting the system

Two options:

- Either when the vehicle is already driving on an eligible road, the driver selects the system by activating the Drive Assist 2.0 system.
- Or when the driver is already using Drive Assist Plus, the vehicle suggests selecting the system upon arriving at an eligible road by pressing the **OK** button.

## Activation/Deactivation

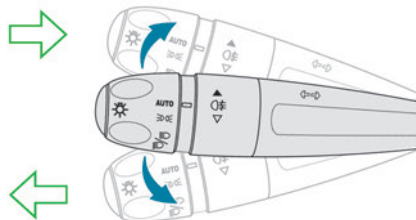

- Activate the direction indicator on the side corresponding to the lane change, whether or not passing the resistance point of the lighting control stalk.

The driver can regain control of the vehicle at any time:

- by deactivating the direction indicator if the vehicle has not yet crossed the line.
- by firmly holding the steering wheel.
- by acting on the pedals.

For more information on the **Direction indicators**, refer to the corresponding section.

## Operating conditions

- Eligible roads: roads with separate carriageways with prohibited access for pedestrians and cyclists.
- The line separating the lanes must be clear enough to be identified by the system.
- The position and speed of other vehicles must enable the system to safely change lanes.
- Drive Assist 2.0 activated.
- Lane positioning assist activated.
- Vehicle speed between 43 and 112 mph (70 and 180 km/h).

## Authorised lane change request

When operating the direction indicator, if the necessary conditions are met, the message "OK?" is displayed on the instrument panel.

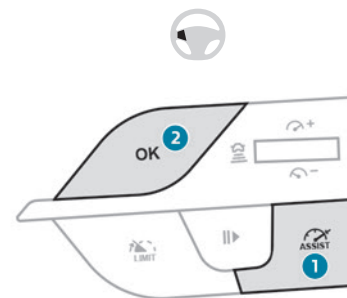

- After checking the surroundings, press **2-OK** to confirm the start of the lane change manoeuvre.

The message "**Stay attentive**" is displayed as a reminder that the driver is still responsible for the manoeuvre.

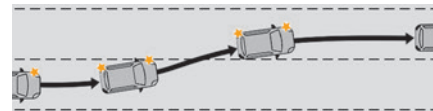

The system then proceeds with the vehicle's lane change.

Once the manoeuvre has been carried out, the system is automatically deactivated and the lane positioning assist takes over.

If the direction indicator has been set beyond the point of resistance, the driver must pull it back.

**I** The driver must hold the steering wheel correctly.

As soon as the semi-automatic lane change begins, the system directs the vehicle to the target lane by small actions on the steering to position it in the destination lane. You can feel the steering wheel moving.

### Interrupting the lane change

It is possible that while changing lane, the necessary conditions for the operation of the system may no longer be met.

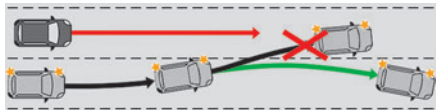

If this occurs before one of the wheels has crossed the line separating the two lanes, the system automatically returns the vehicle to its original lane (confirmed by the display of a manoeuvre cancellation message on the instrument panel and an audible signal). The system is then automatically deactivated.

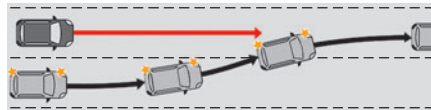

If this occurs when the lane change has started, the system prompts the driver to immediately retake control of the vehicle (confirmed by the display of a message on the

instrument panel and an audible signal), and the system is automatically deactivated.

### Refused lane change request

When operating the direction indicator or pressing **2-OK**, if the necessary conditions are not met, the lines appear in orange on the instrument panel.

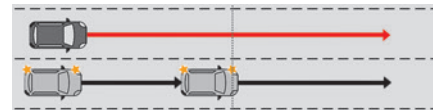





The system keeps the vehicle in the original lane. The system is deactivated and the semi-automatic lane change is not carried out.

## Messages and alerts

The actual order of display of the messages or alerts may be different.

Display	Comments
 <p>(grey)/(continuous grey)/(grey)</p>	<p>System awaiting selection.</p>

Display	Comments
 <p>(grey)/(continuous green)/(green)</p>	System selection request.
 <p>(green)/(continuous green)/(green)</p>	System selected.
 <p>(green)/(broken green)/(green)</p>	Confirmation request for a lane change manoeuvre.
 <p>(green)/(broken green)/(green)</p>	Lane change manoeuvre in progress.
 <p>(green)/(continuous orange)/(green)</p>	Refused lane change manoeuvre when operating the direction indicator or pressing 2-OK.



(orange)

**"Lane change interrupted: Stay in the lane"**

The system cannot manage the current driving situation.

Brake, accelerate or use the steering wheel, depending on the context.



(blue)

**"Lane change canceled"**

Continuation of the systems: Lane positioning assist and Adaptive cruise control.

or

Interruption at the initiative of the driver.



(red)

**"Take back control"**

The system cannot manage the current driving situation.

Brake, accelerate or use the steering wheel, depending on the context.

## Operating limits

The system should only be used on driving lane.

The system may not work in the following situations:

- Wearing thick gloves.
- Poor visibility (insufficient road lighting, snowfall, rain, fog).
- Dazzle (headlamps of an oncoming vehicle, low sun, reflections on a wet road surface, leaving a tunnel, alternating light and shade).
- Windscreen area in front of the camera dirty, misted up, frost-covered, snow-covered, damaged or covered by a sticker.

- Lane markings eroded, partially hidden (snow, mud) or multiple (roadworks, surface joints).
- Travelling in a tight bend.
- Winding roads.
- Road surface repairs.

**!** The system must not be activated in the following situations:

- When changing a wheel or working near a wheel.
- Towing or with a bicycle carrier on a towing device, especially with trailer not plugged in or not approved.
- Adverse weather conditions.
- Road with low grip (risk of aquaplaning, snow, ice).
- Unusual configuration such as road works areas, toll areas and emergency lanes.
- Driving on racing circuits.
- Driving on a rolling road.

**!** If the system detects that the driver is not holding the steering wheel firmly enough, it triggers a series of gradual alerts and then deactivates itself if there is no response from the driver.

## Malfunction



In the event of a malfunction, this warning lamp lights up on the instrument panel, accompanied by the display of a message and an audible signal.

Have it checked by a PEUGEOT dealer or a qualified workshop.

## Active Safety Brake with Collision Risk Alert and Intelligent emergency braking assistance

**!** For more information, refer to the **General recommendations on the use of driving and manoeuvring aids.**



This system:

- warns the driver that their vehicle is at risk of collision with the preceding vehicle, a pedestrian or a cyclist.
- reduces the vehicle's speed to avoid a collision or to limit its severity.

**i** Below a speed of 19 mph (30 km/h), automatic emergency braking may slow down the vehicle to a complete stop.

Otherwise, for versions with camera only, the speed may be reduced by a maximum of 16 mph (25 km/h).

For versions with camera and radar, the speed reduction may be extended to 31 mph



(50 km/h), if both sensors are able to detect the thread.

**i** The system also takes motorcyclists into account.

It may also react on animals. Animals (especially animals smaller than 0.5 m) and objects on the road are not necessarily detected.

This system includes three functions:

- Collision Risk Alert.
- Intelligent emergency braking assistance (iEBA).
- Active Safety Brake (automatic emergency braking).

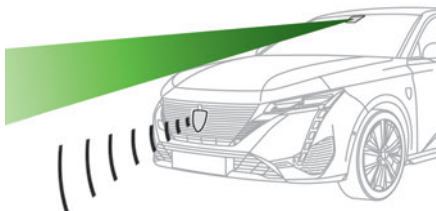

The vehicle has a multifunction camera located at the top of the windscreen and, depending on version, a radar located in the front bumper.

**!** This system does not replace the need for driver vigilance.

This system is designed to assist the driver and improve road safety.

It is the driver's responsibility to continuously monitor traffic conditions in accordance with applicable driving regulations.

**i** As soon as the system detects a potential collision, it prepares the braking circuit. This may cause a slight noise and a slight sensation of deceleration.

## Operating conditions and limits

Vehicle moving forward without trailer.

Brake system operational.

ASR system activated.

Seat belts fastened for all passengers.

Stabilised speed on roads with no or low curvature.

**i** This warning lamp lights up on the instrument panel without any additional message, to indicate that the automatic braking system is not available.

This is a normal behavior indicating that a condition is not fulfilled and which does not request the support of a workshop.

In any situations with ignition on where automatic braking presents a risk, deactivating the system via the driving aids touch screen application is recommended, for instance:

- Carrying long objects on roof bars.
- Using an automatic car wash.

- Performing any maintenance (e.g. changing a wheel, working inside the engine compartment).
- Placing the vehicle on a rolling bench in a workshop.
- Towing the vehicle.
- Following a damage of the windscreen close to the detection camera.

**i** The system is automatically deactivated if:

- A spare wheel with a too small diameter is detected.
- A fault with the brake pedal switch or with the right or left brake lamp is detected.
- A fault in the sensors, in the electronic or in the brake system is detected.
- A trailer is detected by the equipped vehicle hitch (with an electrical connection plug).
- A severe crash (e.g. with airbag deployment) is detected.

**i** In case the detection is degraded or temporarily unavailable by environment conditions, then a driver indication is not displayed (because a driver action is not requested).

**!** It can be dangerous to drive if the brake lamps are not in perfect working order.

**!** The driver must not overload the vehicle (keep within the GVW and GTW limits and load height limits for roof bars).

## Collision Risk Alert

This function warns the driver if there is a risk of collision with the preceding vehicle, or with a pedestrian or cyclist.

### Modifying the alert trigger threshold

The trigger threshold determines the sensitivity with which the function warns of the risk of collision.



► In the **ADAS** touch screen application, select **Functions>Automatic Braking System**.

► Select one of the 3 preset thresholds: "**Far**", "**Medium**" or "**Near**".

The selected threshold is memorised when the ignition is switched off.

### Operation

Depending on the collision risk detected by the system and the alert trigger threshold chosen by the driver, different levels of alert may be triggered and displayed on the instrument panel. The system takes into account the vehicle dynamics, the difference speed of the own vehicle and the object identified for the collision risk, and the operation of the vehicle (e.g. actions on the pedals, steering wheel) to trigger the alert at the most relevant moment.



(orange)

**Level 1:** visual alert only, warning that the preceding vehicle is very close.

The message "**Vehicle close**" is displayed.



(red)

**Level 2:** visual and audible alert, warning that a collision is imminent.

The message "**Brake!**" is displayed.

**Level 3:** a micro-braking may be given, confirming the risk of collision (optional).



While approaching a vehicle too quickly, the level 2 alert may be displayed directly.

**Important:** the level 1 alert depends on the trigger threshold selected. It reacts only on moving vehicles. It is disabled automatically at lower speed.



It is possible that collision warnings are not given, are given too late or seem unjustified.

The driver must always stay in control of the vehicle and be prepared to react at any time to avoid an accident.



If you select "**Far**" in the touch screen, then the system warns sooner. This increases the safety but increases also the amount of alerts, if the legal safety distance is not kept.

To reduce the alert occurrence, you can change the setting to either of the other two.

## Intelligent emergency braking assistance (iEBA)

This function increases vehicle deceleration if the driver does not brake enough to avoid a collision.

This assistance is only provided if the driver presses the brake pedal.

## Active Safety Brake



This function, also called "automatic emergency braking", intervenes after the acoustic alert if the driver does not operate the brake pedal quickly enough.

The system aims at reducing the speed of impact or avoiding a collision if the driver fails to react.

**i** Below a speed of 19 mph (30 km/h), automatic emergency braking may slow down the vehicle to a complete stop. Otherwise, for versions with camera only, the speed may be reduced by a maximum of 16 mph (25 km/h). For versions with camera and radar, the speed reduction may be extended to 31 mph (50 km/h), if both sensors are able to detect the threat.

## Operation

The system operates subject to the following conditions:

- The vehicle's speed does not exceed 50 mph (80 km/h), when a pedestrian or a cyclist is detected.
- The vehicle's speed does not exceed 50 mph (80 km/h), when a stationary vehicle is detected.
- The vehicle's speed is between 6 mph and 53 mph (10 km/h and 85 km/h) (versions with camera only) or 87 mph (140 km/h) (versions with camera and radar) when a moving vehicle is detected.

 This warning lamp flashes (for approximately 10 seconds) as soon as the function applies the vehicle's brakes. During the flashing time, the function is not available.

With an automatic gearbox or drive selector, in the event of automatic emergency braking, keep the brake pedal depressed, also after a complete

stop is reached, to prevent the vehicle from rolling away.

With a manual gearbox, in the event of automatic emergency braking bringing the vehicle to a complete stop, the engine may stall.

**i** The driver can override the automatic emergency braking at any time by strongly turning the steering wheel (evasive manoeuvre) and/or by firmly pressing the accelerator pedal.

**i** The brake pedal may feel hard and vibrate slightly while the function is operating. If the vehicle comes to a complete stop, automatic braking is maintained for 1 to 2 seconds.

## Turning scenarios

### Crossing road with another vehicle

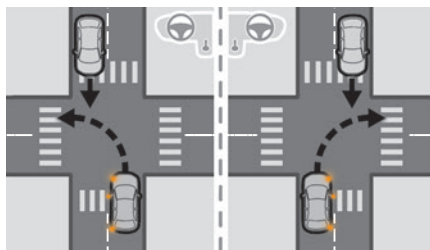

The system may operate when the vehicle is turning and detects another vehicle, on the adjacent lane, approaching from the opposite direction if:

- The corresponding direction indicator is activated.
- Then the vehicle is about to cross the path of another vehicle.
- The vehicle speed is between 3 and 12 mph (5 and 20 km/h).
- A collision on the side of the other vehicle is probable.

### Crossing road with a pedestrian

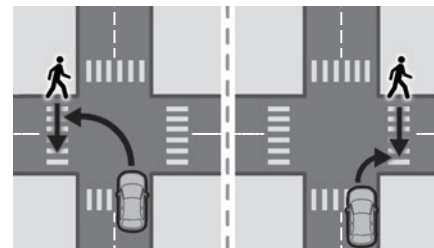

The system may operate when the vehicle is turning left or right and detects a crossing pedestrian if:

- The pedestrian is crossing in front of the vehicle.
- The pedestrian can clearly be detected by the sensors.
- The scenery is detectable by the sensors (e.g. brightness, contrast vs background).

- The vehicle speed is between 3 and 15 mph (5 and 25 km/h).

## Deactivation/Activation

By default, the system is automatically activated at every engine start.



It is configured in the **ADAS** touch screen application.



Deactivation of the system is signalled by the illumination of this warning lamp, accompanied by the display of a message.



The system cannot be deactivated above 10 km/h.

## Malfunction



This warning lamp lights up on the instrument panel with the message "**Driving Assistance Sensor blind: Clean sensor, see User Manual**" if the sensor is masked.

This is a normal behavior, which does not request the support of a qualified workshop. In this case, stop the vehicle and verify if the front camera or the front radar is covered by dirt, mud, sand, snow, ice or anything preventing the sensing.

The system is operational again after the detection field has been cleaned.



In the event of a malfunction, this warning lamp lights up on the instrument panel,

accompanied by the display of a message and an audible signal.

Have it checked by a PEUGEOT dealer or a qualified workshop.



If these warning lamps come on after the engine has been switched off and then restarted, contact a PEUGEOT dealer or a qualified workshop to have the system checked.



These warning lamps light up on the instrument panel and/or in the warning lamp display for seat belts and front passenger airbag to indicate that the driver's and/or front passenger's seat belt is not fastened (depending on version). The automatic braking system is deactivated until the seat belts are fastened.

## Distraction detection



For more information, refer to the **General recommendations on the use of driving and manoeuvring aids.**

The function comprises the "Driver Attention Warning" system combined with the "Driver Attention Warning by Camera" system.



These systems are in no way designed to keep the driver awake or to prevent the driver from falling asleep at the wheel. It is the driver's responsibility to stop if feeling tired.

Take a break if you are feeling tired or at least every 2 hours.

## Driver Attention Warning



The system triggers an alert when it detects that the driver has not taken a break after two hours of driving at a speed above 43 mph (70 km/h).

This alert is issued via the display of a message encouraging the driver to take a break, accompanied by an audible signal.

If the driver does not follow this advice, the alert is repeated hourly until the vehicle is stopped. The system resets itself if one of the following conditions is met:

- With the engine running, the vehicle has been stationary for more than 15 minutes.
- The ignition has been switched off for a few minutes.
- The driver's seat belt is unfastened and their door is opened.



As soon as the speed of the vehicle drops below 43 mph (70 km/h), the system goes into standby. Driving time starts being counted again once the speed reaches above 43 mph (70 km/h).

## Driver Attention Warning by Camera

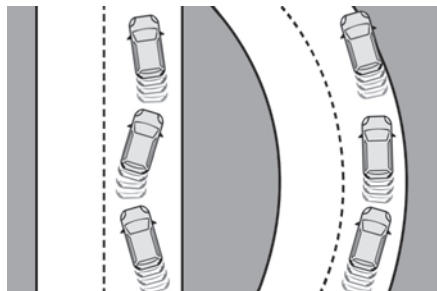

 The system assesses the driver's level of alertness, fatigue and distraction by identifying trajectory changes in relation to the lane markings.

To do this, the system uses a camera, placed on the upper part of the windscreen.

This system is particularly suited to fast roads (speed higher than 43 mph (70 km/h)).

-  The system may perform a learning procedure for up to 30 minutes after the start of the monitoring.
- During this period, the driver's individual driving behaviour is analysed and no alert is given.

At a first alert level, the driver is warned by the message "**Caution!**", accompanied by an audible signal.

After three first-level alerts, the system triggers a further alert with the message "**Driving at risk: Take a break!**", accompanied by a more pronounced audible signal.

-  In certain driving conditions (poor road surface or strong winds), the system may give alerts independent of the driver's level of vigilance.

 The following situations may interfere with the operation of the system or prevent it from working:

- Lane positioning assist is active.
- poor visibility (e.g. inadequate street lighting, heavy rain, thick fog, snowfall).
- dazzle (e.g. headlamps of an oncoming vehicle, low sun, reflections on a damp road, leaving a tunnel, alternating shade and light).
- windscreen area located in front of the camera (e.g. dirty, misted, frost-covered, snow-covered, damaged or masked by a sticker).
- lane markings absent, worn, hidden (e.g. snow, mud, dead leaves) or multiple (roadworks).
- close to the vehicle ahead (lane markings not detected).
- roads that are narrow, winding.

## Deactivation/Activation

By default, the function is automatically activated at every engine start.



The settings are changed via the **ADAS** touch screen application.

or

Direct access to the **Shortcuts for driving aids**.



Deactivation is confirmed by the illumination of this indicator lamp on the instrument panel.

## Malfunction



In the event of a malfunction, this warning lamp lights up on the instrument panel, accompanied by the display of a message and an audible signal.

Have it checked by a PEUGEOT dealer or a qualified workshop.



This warning lamp lights up on the instrument panel with the message

**"Driving Assistance Sensor blind: Clean sensor, see User Manual"** if the sensor is masked.

This is a normal behavior, which does not request the support of a qualified workshop.

In this case, stop the vehicle and verify if the front camera is covered by dirt, mud, sand, snow, ice or anything preventing the sensing. The system is operational again after the detection field has been cleaned.

## Lane keeping assist

**!** For more information, refer to the **General recommendations on the use of driving and manoeuvring aids.**

The system corrects the vehicle's trajectory by alerting the driver as soon as it detects a risk of involuntary lane departure or crossing of a verge or hard shoulder (depending on version).

To do this, the system uses a camera, placed on the upper part of the windscreen, identifying the lane markings on the ground and the side of the road (depending on version).

**This system is particularly useful on motorways and main roads.**

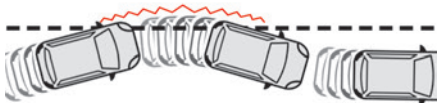

## Operating conditions

- Vehicle speed between 43 and 112 mph (70 and 180 km/h).
- Road marked with a central dividing line.
- Steering wheel held with both hands.
- Direction indicators off upon activation of the system.
- ESC system activated and operational.

**!** The system helps the driver only if there is a risk of the vehicle unintentionally wandering from the lane it is being driven in. It does not manage the safe driving distance, vehicle speed or braking. The driver must hold the steering wheel with both hands so that they can maintain control when the conditions no longer allow the system to intervene (e.g. in the event that the central dividing line marking on the road surface disappears).

## Operation

As soon as the system identifies a risk of involuntarily crossing one of the lane markings detected on the ground or a lane boundary (e.g. grass verge), it performs the trajectory correction necessary to restore the vehicle to its original lane.

The driver will notice a turning movement of the steering wheel.



This warning lamp flashes during trajectory correction.





**i** The driver can prevent the correction by firmly holding the steering wheel (e.g. during an emergency manoeuvre). The correction is interrupted immediately if the direction indicators are operated.

While the direction indicators are activated and for a few seconds after switching them off, the system considers that a change of trajectory is intentional and no correction is triggered during this period.

## Driving situations and related alerts

The table below describes the alerts and messages displayed in different driving situations. The actual order of display of these alerts may be different.

Function status	Display	Comments
OFF		Function deactivated.

Function status	Display	Comments
ON	None.	System active, conditions not met: <ul style="list-style-type: none"> <li>– Speed below 40 mph (65 km/h).</li> <li>– No lane marking recognised.</li> <li>– ESC operation triggered.</li> <li>– "Sporty" driving.</li> </ul>
ON		Automatic deactivation/standby of the function (e.g. detection of a trailer, use of the "space-saver" type spare wheel supplied with the vehicle, failure).
ON	None.	Lane marking detected. Speed above 40 mph (65 km/h).
ON		The system corrects the trajectory on the side where the risk of line crossing is detected. The driver's hands are on the steering wheel.
ON	    <b>"Hold the steering wheel" or "Stay in lane"</b> (depending on version)	<p>If, while correcting the trajectory, the system determines that the correction will not be enough and that a solid line will be crossed: the driver is warned that they must provide additional trajectory adjustment.</p> <p>If the steering wheel is not held properly, an audible warning sounds, accompanied by a message, until the trajectory correction is completed or the driver has grasped the steering wheel correctly.</p> <p>The duration of audible warnings will increase if multiple corrections are performed in quick succession. The warning will become continuous, persisting until the driver responds.</p>

## Operating limits

The system goes into standby automatically in the following cases:

- ESC deactivated or operation triggered.
- Speed below 40 mph (65 km/h) or greater than 112 mph (180 km/h).
- Electrical connection to a trailer.

- Use of a "space-saver" spare wheel detected (as detection is not immediate, deactivation of the system is recommended).
- Dynamic driving style detected, pressure on the brake or accelerator pedal.
- Driving over lane markings.
- Activation of the direction indicators.

- Crossing the inside line on a bend.
- Driving on a tight bend.
- Inactivity by the driver detected during correction.
- Narrow lane detected.

**!** The following situations may interfere with the operation of the system or prevent it from working:

- Insufficient contrast between the road surface and the verge or hard shoulder (e.g. shade).
- Lane markings worn, hidden (e.g. snow, mud) or multiple (e.g. roadworks).
- Close proximity to the vehicle in front (lane markings may not be detected).
- Roads that are narrow, winding.

### Risk of undesirable operation

The system should be deactivated in the following situations:

- When changing a wheel or working near a wheel.
- Towing or with a bicycle carrier on a towing device, especially with trailer not plugged in or not approved.
- Road in poor condition, unstable or with very poor grip (risk of aquaplaning, snow, ice).
- Adverse weather conditions.
- Driving on racing circuits.
- Driving on a rolling road.

### Deactivation/Activation

By default, the system is automatically activated at every engine start.



It is configured in the **ADAS** touch screen application.

or

Direct access to the **Shortcuts for driving aids**.



Deactivation is confirmed by the illumination of this indicator lamp on the instrument panel.

### Malfunction



In the event of a malfunction, these warning lamps light up on the instrument panel, accompanied by the display of a message and an audible signal. Have it checked by a PEUGEOT dealer or a qualified workshop.



This warning lamp lights up on the instrument panel with the message **"Driving Assistance Sensor blind: Clean sensor, see User Manual"** if the sensor is masked.

This is a normal behavior, which does not request the support of a qualified workshop. In this case, stop the vehicle and verify if the front camera is covered by dirt, mud, sand, snow, ice or anything preventing the sensing. The system is operational again after the detection field has been cleaned.

### Long-distance blind spot monitoring

**!** For more information, refer to the **General recommendations on the use of driving and manoeuvring aids**.

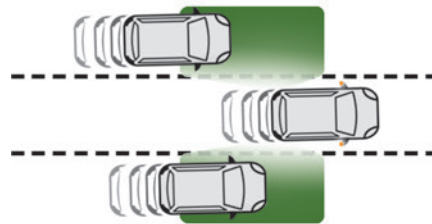

This system warns the driver of vehicles approaching rapidly from the rear in adjacent lanes (up to around 75 m) and of the presence of a vehicle in the blind spots of their vehicle, using corner radars located in the rear bumper.

**i** This system takes into account vehicles such as cars, lorries and motorcycles by monitoring the blind spots or areas hidden from the driver's field of vision.

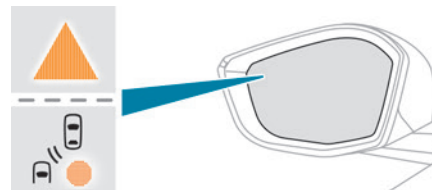

A warning lamp appears in the door mirror on the side in question:

– **Fixed**, immediately when another vehicle is in the blind spot or is approaching in an adjacent lane.



- **Flashing**, after about 1 second when the direction indicator is used.

## Activation/Deactivation



It is configured in the **ADAS** touch screen application.

When starting the vehicle, the warning lamp comes on in each mirror to indicate that the system is activated.

The status of the system is memorised when the ignition is switched off.

- i** The system is automatically deactivated when towing with a towing device approved by PEUGEOT.

## Operating conditions

- All vehicles are moving in the same direction and in adjacent lanes.
- When overtaking a vehicle, the speed difference is less than 9 mph (15 km/h).
- Traffic is flowing normally.
- Overtaking a vehicle over a certain period of time and the vehicle being overtaken remains in the blind spot.

## Operating limits

No alert is triggered in the following conditions:

- presence of stationary objects (e.g. parked vehicles, safety rails, lampposts, signs).
- vehicles travelling in the opposite direction.
- if the rear bumper is damaged.

- !** It is possible that warnings are not given, are given too late or seem unjustified.

This system does not replace the need for vigilance on the part of the driver. Always check in the mirrors and look over your shoulders before changing lanes to avoid an accident.

If the rear bumper is to be repainted, contact a PEUGEOT dealer or a qualified workshop; certain types of paint could interfere with the operation of the radars.

## Malfunction



If the event of a malfunction, this warning lamp lights up on the instrument panel, accompanied by the display of a message.

Have it checked by a PEUGEOT dealer or a qualified workshop.

- i** The system may be temporarily disturbed by certain weather conditions (e.g. heavy rain, hail or extreme temperature changes). In particular, driving on a wet road or going from a dry to a wet area can cause false alerts (e.g. presence of a cloud of water droplets in the blind spot interpreted as a vehicle).

In bad or wintry weather, ensure that the radars are not covered by mud, ice or snow.

Take care not to cover the warning zone in the door mirrors, or the detection zones on the rear bumper, with adhesive labels or

other objects; they may hamper the correct operation of the system.

## Parking sensors

- !** For more information, refer to the **General recommendations on the use of driving and manoeuvring aids**.

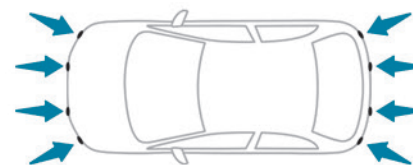

This system detects and signals the proximity of obstacles (e.g. pedestrian, vehicle, tree, barrier) using sensors located in the bumper.

## Rear parking sensors

System startup is available under the following conditions:

- when reverse gear is engaged.
- when the vehicle is moving backwards (e.g. downhill, in neutral).

It is indicated by an audible confirmation signal and a display indication.

- i** If an obstacle is detected as soon as the reverse gear is engaged, an audible

detection signal is given directly instead of the audible confirmation signal.

If no audible signal is given, the display indication is not shown or a warning message appears, the system has a failure.

## Audible assistance

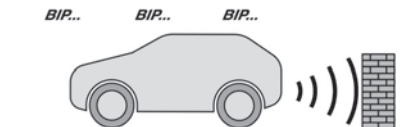

The system signals the presence of obstacles which are both within the sensors' detection zone and in the vehicle path defined by the direction of the steering wheel.

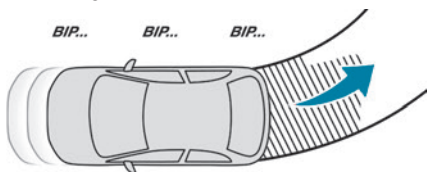

Depending on version, in the example shown, only the obstacles present in the shaded area will be signalled by the audible assistance. The proximity information is given by an intermittent audible signal, the frequency of which increases as the vehicle approaches the obstacle.

When the distance between the vehicle and the obstacle becomes less than about thirty centimetres, the audible signal becomes continuous.

The sound emitted by the speaker (right or left) indicates the side on which the obstacle is located.

The audible signal is automatically suspended when the vehicle is stationary for a few seconds. The audible signal is automatically restored when the vehicle is moving again or if the obstacle approaches the vehicle.

### Adjusting the audible detection signal



Pressing this button opens the window for adjusting the volume

of the audible signal.



Pressing this button mutes/unmutes the audible signal.

## Visual assistance



This supplements the audible signal, without taking account of the vehicle's trajectory, by displaying bars on the screen whose location represents the distance between the obstacle

and the vehicle (white: more distant, orange: close, red: very close).

When the obstacle is very close, the "Danger" symbol is displayed on the screen.

### Closing the system display window



Pressing this button closes the system display window.



This warning lamp flashes during obstacle detection on the instrument panel.

### Muting the audible assistance / Closing the visual assistance

If the audible detection signal is muted or the system display window is closed by the driver during the obstacle detection, only the warning lamp continues to flash on the instrument panel.

## Front parking sensors

Supplementing the rear parking sensors, the front parking sensors are triggered when an obstacle is detected in front and the speed of the vehicle is below 6 mph (10 km/h).

Front parking sensor operation is suspended if the vehicle stops for more than three seconds in forward gear, if an obstacle is no longer detected or the vehicle speed exceeds 6 mph (10 km/h).

The sound emitted by the speaker (front or rear) locates the obstacle relative to the vehicle, whether in front of or behind it on its path.

## Deactivation/Activation

(Depending on country of sale)

By default, the audible signal is automatically activated at each time the reverse gear is engaged.

**i** The system cannot be deactivated.

Depending on version, using the centre console button and/or in the **ADAS** application on the touch screen.



► Press this button to activate or deactivate the audible signal.

The indicator lamp is lit when the audible signal is deactivated.



You can start the system manually and activate/deactivate the audible signal in the **ADAS** touch screen application.



**i** The rear parking sensors are deactivated automatically if a trailer or bicycle carrier is connected to a towing device installed in accordance with the Manufacturer's recommendations.

In this case, the outline of a trailer is displayed at the rear of the image of the vehicle.

**i** When starting the vehicle, the graphic and audible aids are only available after the touch screen has started up.

## Operating limits

If the boot is heavily loaded, the vehicle may tilt, affecting distance measurements.

In case of a gearbox failure, the system is not active, when the reverse gear is engaged.

## Malfunction

**P) Δ** In the event of a malfunction, this warning lamp lights up on the instrument panel, accompanied by the display of a message and an audible signal (short beep).

**P) Δ OFF** In the event of a malfunction, this indicator lamp flashes for approximately 10 seconds when reverse gear is engaged. Have it checked by a PEUGEOT dealer or a qualified workshop.

**P) Δ** This warning lamp lights up on the instrument panel with the message **"Parking Assistance Sensor blind: Clean sensor, see User Manual"** if the sensor is masked.

This is a normal behavior, which does not request the support of a qualified workshop. In this case, stop the vehicle and verify if the front and/or rear sensors are covered by dirt, mud, sand, snow, ice or anything preventing the sensing.

The system is operational again after the detection field has been cleaned.

## Visiopark 1

**!** For more information, refer to the **General recommendations on the use of driving and manoeuvring aids.**

When reverse gear is engaged, with the engine running, this system displays views of the vehicle's close surroundings on the touch screen using a camera located at the rear of the vehicle.

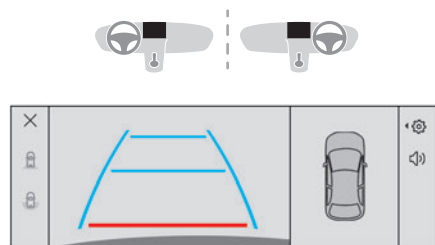

The screen is divided into 3 parts with a side menu, a contextual view and a view from above the vehicle in its close surroundings.

The parking sensors supplement the information in the view from above the vehicle.

Different contextual views are available:

- Automatic zoom view.
- Standard view.
- Panoramic view.

Depending on the context, the system chooses the best view to display (standard or automatic zoom).

The view type can be changed at any time during the manoeuvre.

The system status is not saved when the ignition is switched off.

## Operating principle

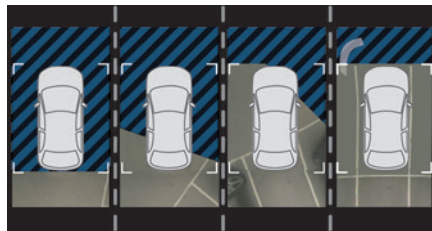

Using the camera, the vehicle's close surroundings are recorded during low speed manoeuvres.



An image from above the vehicle in its close surroundings is created in real time (on the side of the screen), as the vehicle progresses.

This view makes it easier to align the vehicle when parking and to perceive nearby obstacles. It is automatically deleted if the vehicle remains stationary for too long.

**i** An additional jet is fitted above the number plate to clean the reversing camera (depending on version).

## Settings

In the side menu:

-  This window allows to adjust the volume of the audible signal.
-  This button allows to mute/unmute the audible signal.

 This button allows to trig the camera washing (depending on equipment).

## Activation/Deactivation

To activate the camera, engage reverse gear.

The system is deactivated:

- when changing out of reverse gear.
- by pressing the cross in the top left-hand corner of the touch screen.

## Automatic zoom view

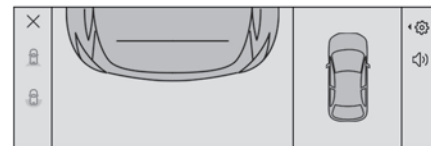

The rear camera records the vehicle's surroundings during the manoeuvre in order to create a view from above the rear of the vehicle in its close surroundings, allowing the vehicle to be manoeuvred around nearby obstacles.

Using the sensors located on the rear bumper, the automatic zoom view is displayed when approaching an obstacle at the red line (less than 30 cm) during the manoeuvre.

This view is only available automatically.

**i** Obstacles may appear further away than they actually are.

It is important to monitor the sides of the vehicle during the manoeuvre, using the mirrors.

Parking sensors also provide additional information about the area around the vehicle.

## Standard view

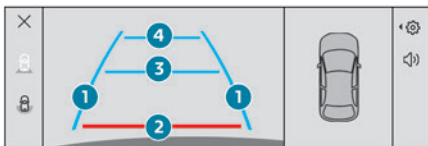

The area behind the vehicle is displayed on the screen.

The blue lines **1** represent the width of your vehicle, with the mirrors unfolded; their direction changes according to the position of the steering wheel.

The red line **2** represents a distance of 30 cm from the rear bumper; the two blue lines **3** and **4** represent 1 m and 2 m, respectively.

This view is available automatically or by selection in the side menu.

## Panoramic view



The panoramic view allows you to leave, in reverse, a parking space by anticipating the arrival of vehicles, pedestrians or cyclists. This view is not recommended for carrying out a complete manoeuvre.

This view is only available by selection in the side menu.

## Visiopark 3

**!** For more information, refer to the **General recommendations on the use of driving and manoeuvring aids.**

This system allows you to view your vehicle's close surroundings on the touch screen using the cameras, located at the front and rear of the vehicle, as well as under the door mirrors.

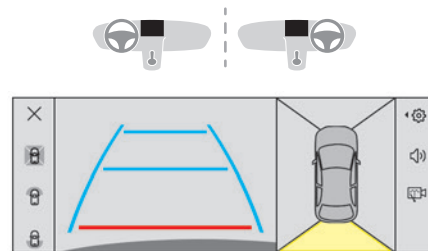

The screen is divided into 4 parts with two side menus, a contextual view and a view from above the vehicle in its close surroundings.

The parking sensors supplement the information in the view from above the vehicle.

Depending on the view angle chosen in the left-hand side menu, the system provides specific visual assistance in particular driving conditions, such as entering a blind intersection or manoeuvring in areas with reduced visibility. Different contextual views are available for the rear or for the front:

- Automatic zoom view.
- Standard view.
- Panoramic view.

Depending on the context, the system chooses the best view to display (standard or automatic zoom).

The view type can be changed at any time during the manoeuvre.

The system status is not saved when the ignition is switched off.

## Operating principle

### Reconstructed view

The cameras are activated and a reconstruction of a view from above your vehicle in its close surroundings is displayed on the touch screen.

### Live view



The front, rear and side views automatically appear in the view from above the vehicle.

It is also possible to display any live view by selecting the corresponding zone.

The front view can be selected in forward gear up to 10 mph (16 km/h).

**i** Installing the very cold climate screen can alter the image transmitted by the front camera.

**i** An additional jet is fitted above the number plate to clean the reversing camera (depending on version).

## Settings

In the side menu:



This window allows to adjust the volume of the audible signal.



This button allows to mute/unmute the audible signal.



This button allows to trig the camera washing (depending on equipment).

## Activation/Deactivation

### Automatic

With the rear camera, engine running and vehicle stationary, rear vision is displayed automatically if reverse gear is engaged.

With the front camera, engine running and speed below 10 mph (16 km/h), rear vision is displayed automatically if a gear is engaged.

### Manual



► In the **ADAS** touch screen application, select **Functions>Panoramic Camera**

The system is deactivated:

- automatically for the rear, when changing out of reverse gear.
- automatically for the front, above approximately 10 mph (16 km/h).
- by pressing the cross in the top left-hand corner of the touch screen.

## Automatic zoom view

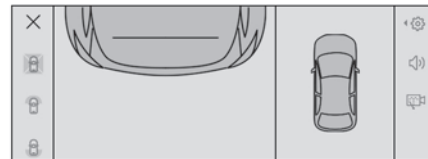

The front or rear camera records the surroundings during the manoeuvre to create a front or rear view from above the vehicle in its close surroundings, making it possible to manoeuvre the vehicle around the surrounding obstacles.

Using the sensors located on the front or rear bumper, the automatic zoom view is displayed when approaching an obstacle at the red line (less than 30 cm) during the manoeuvre.

This view is only available automatically.

Depending on version, it can be activated/deactivated in the **ADAS** application of the touch screen.

**i** Obstacles may appear further away than they actually are.

It is important to monitor the sides of the vehicle during the manoeuvre, using the mirrors.

Parking sensors also provide additional information about the area around the vehicle.

## Standard view

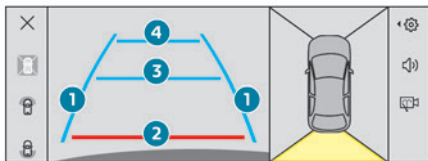

Depending on the context, the area behind or in front of your vehicle is displayed on the screen. The blue lines (at the rear)/orange lines (at the front) **1** represent the width of your vehicle, with the mirrors unfolded; their direction changes according to the position of the steering wheel. The red line **2** represents a distance of 30 cm from the rear or front bumper; the two blue lines (at the rear)/orange lines (at the front) **3** and **4** represent 1 m and 2 m respectively. This view is available automatically or by selection in the left-hand side menu.

## Panoramic view



The rear or front panoramic view allows you to leave a parking space by anticipating the arrival of vehicles, pedestrians or cyclists.

This view is not recommended for carrying out a complete manoeuvre. This view is only available by selection in the left-hand side menu.

## Side views

The left-hand/right-hand side view allows you to view the surroundings of each side of the vehicle (e.g. pavement, low wall, other vehicle parked next to it).

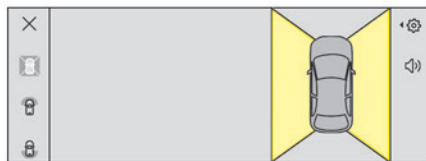

► Select the relevant view in the view from above the vehicle. The selected area turns yellow and the side view appears in the middle of the screen. This view is not recommended for carrying out a complete manoeuvre.

## Rear cross traffic alert

! For more information, refer to the **General recommendations on the use of driving and manoeuvring aids.**

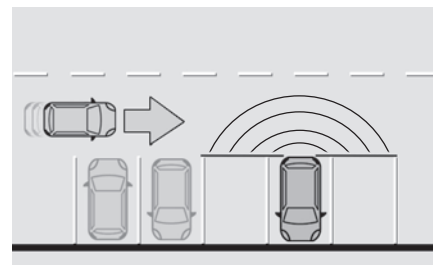

When engaging reverse gear with the engine running, or when reversing at up to 6 mph (10 km/h), this system warns of approaching obstacles (e.g. pedestrian, cyclist, vehicle, truck, motorcycle) in the rear blind spots of the vehicle, using the radars installed in the bumper. The system detects obstacles moving more than 2 mph (3 km/h) at a maximum distance of 40 m. The system operates in addition to the Parking sensors, Visiopark 1 or Visiopark 3 functions (depending on version). For more information about the **Parking sensors, Visiopark 1 or Visiopark 3** functions, refer to the corresponding sections.

! The driver must monitor their surroundings before and during the whole manoeuvre. Drive slowly and carefully in reverse gear in case of reduced or no visibility.

## Operating principle

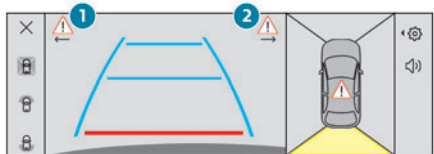

When an approaching obstacle is detected, the symbol **1** or **2** flashes on the touch screen, in the Parking sensors view or in the various contextual views of the Visiopark 1 or Visiopark 3 functions (depending on version).

The symbol is complemented by an audible signal when the vehicle is reversing.



An obstacle is approaching in the blind spot on the rear right-hand/left-hand side or on both sides of the vehicle.

In the event of a malfunction of these visual display functions, the touch screen, or if the driver deactivates the views of these functions on the touch screen, detection of an approaching obstacle is still indicated by the audible signal when the vehicle is reversing.

## Activation/Deactivation



It is configured in the **ADAS** touch screen application.

The system's status is saved when the ignition is switched off.

## Operating limits

The system may not work in the following cases:

- Towing a trailer.
- Using a bicycle carrier on a towing device.
- Extreme temperature changes.
- Damaged rear bumper.
- Accumulation or projection of external elements (e.g. mud, frost, snow), stickers application.

**!** It is possible that warnings are not given, are given too late or seem unjustified.

Consequently, always stay in control of your vehicle and be prepared to react at any time to avoid an accident.

**!** In the event of repainting the rear bumper, consult the PEUGEOT dealer or a qualified workshop; certain types of paint could interfere with the operation of the radars.

## Malfunction

In the event of a malfunction when engaging reverse gear, during reversing or when the driver attempts to activate the system, a message

appears on the instrument panel, accompanied by an audible signal.

Have it checked by a PEUGEOT dealer or a qualified workshop.

This message appears on the instrument panel

**"Parking Assistance Sensor blind: Clean sensor, see User Manual"** if the sensor is masked.

This is a normal behavior, which does not request the support of a qualified workshop. In this case, stop the vehicle and verify if the corner radars, the reversing camera and/or parking rear sensors are covered by dirt, mud, sand, snow, ice or anything preventing the sensing.

The system is operational again after the detection field has been cleaned.





\* 1L & 5L produced in Europe

## Peugeot & TotalEnergies, a partnership in performance!

For more than 25 years of partnership, TotalEnergies and Peugeot have pushed the limits of performance in sports competition with historic victories, in endurance races or in rallies. Today, the two brands continue their shared motorsport adventure by setting out to conquer the 24 Hours of Le Mans and the FIA World Endurance Championship in the Hybrid Hypercar category. So many challenges for which Peugeot exclusively recommends high-tech Quartz lubricants for the protection of its engines throughout their life. In the same way, TotalEnergies equips Peugeot vehicles with Quartz lubricants from their first filling in the factory through to the authorised servicing dealer network to guarantee them optimal day-to-day operation. Peugeot & TotalEnergies: official partners in performance!

### Keep your engine younger for longer!

**Quartz Ineo Xtra First 0W-20** is a very high-performance lubricant resulting from the joint work of the Peugeot and TotalEnergies R&D teams. Its innovative technology extends your engine's life while achieving significant fuel savings and thus limiting CO<sub>2</sub> emissions. The product is now available in new packaging\* made of 50% recycled material and which is 100% recyclable.



PEUGEOT RECOMMENDS **TotalEnergies**

OFFICIAL PARTNERS

## Compatibility of fuels



Petrol fuels conforming to the EN228 standard containing up to 5% and 10% ethanol respectively.



Diesel fuels conforming to the EN590, EN16734 and EN16709 standards and containing up to 7%, 10%, 20% and 30% fatty acid methyl ester respectively. The use of B20 or B30 fuels, even occasionally, imposes special maintenance conditions referred to as "Arduous conditions".



Paraffinic Diesel fuel conforming to the EN15940 standard.

**!** The use of any other type of (bio) fuel (e.g. pure or diluted vegetable or animal oils, domestic fuel) is strictly prohibited - risk of damaging the engine and fuel system!

**i** The only fuel additives authorised for use are those that meet the B715001 (Petrol) or B715000 (Diesel) standards.

### Diesel at low temperature

At temperatures below 0 °C (+32 °F), the formation of paraffins in summer-type Diesel

fuels could prevent the engine from operating correctly. In these temperature conditions, use winter-type Diesel fuel and keep the fuel tank more than 50 % full.

At temperatures below -15 °C (+5 °F) to avoid problems starting, it is best to park the vehicle under shelter (heated garage).

### Travelling abroad

**Certain fuels could damage your vehicle's engine.**

**In certain countries, the use of a particular fuel may be required (specific octane rating, specific trade name, etc.) to ensure correct operation of the engine.**

For all additional information, consult a dealer.

## Refuelling

**Fuel tank capacity: approximately 52 litres (Petrol, Diesel or Hybrid) or 40 litres (Rechargeable hybrid).**

**Reserve level: approximately 6 litres.**

### Low fuel level



When the low fuel level is reached, this warning lamp lights up on the instrument panel, accompanied by the display of a message and an audible signal. When it first comes on, **about 6 litres** of fuel remain.

Until sufficient fuel is added, this warning lamp appears every time the ignition is switched on, accompanied by the message and the audible

signal. When driving, this message and audible signal are repeated with increasing frequency as the fuel level drops towards **0**.

You must refuel as soon as possible to avoid running out of fuel.

For more information on **Running out of fuel (Diesel)**, refer to the corresponding section.

**i** A small arrow by the warning lamp indicates which side of the vehicle the fuel filler flap is located on.

**!** **Stop & Start / e-Auto mode**  
Never refuel with the engine in STOP mode or in stand-by; you must switch off the ignition.

## Refuelling

Any addition of fuel must be in quantities of at least 10 litres, in order to be registered by the fuel gauge.

Opening the filler flap may create a noise caused by an inrush of air. This vacuum is entirely normal, resulting from the sealing of the fuel system.

To refuel in complete safety:

► **Always switch off the engine.**

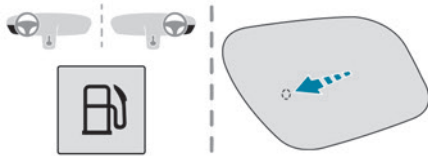

- ▶ To open the filler flap, press the flap opening button for more than 2 seconds or, with the vehicle unlocked, press the rear of the filler flap (depending on version).

#### **i** Rechargeable hybrid vehicles

After pressing the button on the dashboard, the filler flap may not open for several minutes. A sound is emitted when the filler flap opens.

If the flap becomes stuck, press and hold the button on the dashboard for more than 3 seconds.

- ▶ Select a pump that delivers the correct fuel type for the vehicle's engine (see a reminder label on the inside of the filler flap).

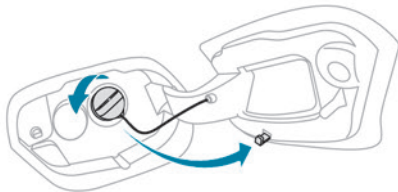

- ▶ Turn the filler cap to the left, remove it and place it on its support on the filler flap (depending on version).

- ▶ Insert the filler nozzle and push it in as far as possible before starting to refuel (to minimise the risk of splashing).

- ▶ Fill the tank.

**Do not continue after the nozzle's third cut-out. Doing so may cause malfunctions.**

- ▶ Put the filler cap back in place and turn it to the right (depending on version).
- ▶ Push the fuel filler flap to close it.

The vehicle is fitted with a catalytic converter, which helps to reduce the level of harmful emissions in the exhaust gases.

**For petrol engines, you must use unleaded fuel.**

The filler neck is narrower, allowing only unleaded petrol nozzles to be inserted.

**!** If you have put in the wrong fuel for the vehicle, you must have the fuel tank drained and filled with the correct fuel before starting the engine.

## Misfuel prevention (Diesel)

(Depending on country of sale.)

This mechanical device prevents filling the tank of a Diesel vehicle with petrol.

Located in the filler neck, the misfuel prevention device is visible when the filler cap is removed.

## Operation

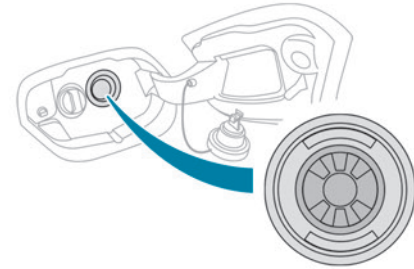

When a petrol filler nozzle is introduced into the fuel filler neck of a Diesel vehicle, it comes into contact with the flap. The system remains closed and prevents filling.

**Do not persist but introduce a Diesel type filler nozzle.**

**i** The misfuel prevention device does not prevent filling with a jerrycan, regardless of the fuel type.

#### **i** Travelling abroad

As Diesel fuel pump nozzles may be different in other countries, the presence of the misfuel prevention device may make refuelling impossible. Before travelling abroad, it is advisable to check with a PEUGEOT dealer if the vehicle is suitable for the distribution equipment of the countries visited.

## Electrified vehicles - General recommendations

These recommendations and general information concern electrified vehicles of the type: hybrid, rechargeable hybrid and electric.

### High voltage system

- ! High voltage system voltage is dangerous and can cause burns or other injuries or even fatal electric shock. Since damage to high voltage components is not visible, PEUGEOT recommends that you:
  - Never touch the components, damaged or not, and never let your jewelry or other metallic objects come into contact with these components.
  - Never work on the high voltage cables (purple or orange) or on any other high voltage component marked with the Electric risk label. Any intervention on the high voltage system must be carried out by qualified persons in workshops qualified and approved to carry out this type of work.
  - Never damage, modify or remove the high voltage cables (purple or orange) or disconnect them from the high voltage network.
  - Never open, modify or remove the cover of the traction battery.

- Never work with cutting and forming tools or heat sources near high voltage components and cables. In case of low level of fluid in the cooling tank, the refilling shall only be performed in a qualified and trained workshop to verify that the leakage is not in the traction battery. Any intervention on the high voltage system must be carried out by qualified persons in workshops qualified and approved to carry out this type of work. Damage to the vehicle or the traction battery could result in the leakage of toxic gases or fluids either immediately or later. PEUGEOT recommends that you:
  - Always inform the fire and emergency services in the event of an incident, warning that the vehicle is equipped with a traction battery.
  - Never touch the liquids leaking from the traction battery.
  - Do not inhale the gases emitted by the traction battery which are toxic.
  - Move away from the vehicle in the event of incident or accident, the gases emitted being flammable and could cause a fire.

### Traction battery

#### Traction battery overheating



If the following warning lamps appear, accompanied by the

display of a message and an audible signal, it is required to:

- ▶ Stop the vehicle as soon as possible in the best conditions of safety.
- ▶ Switch off the ignition.
- ▶ Evacuate the vehicle as quickly as possible and move to a safe distance.
- ▶ Call the fire department and/or the emergency services and tell them that the vehicle is an electric one.

#### ! Danger of death / Risk of serious injury

A chain reaction can occur up to a traction battery fire.

#### ! In the event of damage to the traction battery

It is strictly prohibited to work on the vehicle yourself.

Do not touch liquids coming from the battery, and in the event of skin contact with these products, wash abundantly with water and contact a doctor as soon as possible. Contact a PEUGEOT dealer or a qualified workshop to have the system checked.

### Disposal of the traction battery

The traction battery is designed for the life of the vehicle if the recommendations of PEUGEOT are followed.

If it becomes necessary to replace the battery, contact the PEUGEOT dealer for instructions on its disposal. Improper disposal carries the risk of severe burns, electric shock, and damage to the environment.

In accordance with regulations, PEUGEOT ensures a second life or recycling of this component in collaboration with qualified operators.

## Hybrid system

### Electrical system

**!** For more information, refer to the **General recommendations on electrified vehicles.**

The electrical circuit of the hybrid system is identified by purple cables and its components are marked with this symbol:



**!** The hybrid powertrain uses a voltage of 48 V. This system may be hot both when the ignition is on and after switching it off. Comply with the warning messages shown on the labels.

#### **!** In the event of an accident with an airbag deployment

The traction battery is automatically disconnected from the electrical circuit to prevent the initiation of short circuits and/or fires.

#### **In the event of an impact to the vehicle's underbody**

In these situations, the electrical circuit or the traction battery can be seriously damaged. Stop as soon as it is safe to do so and switch off the ignition. Move away from the vehicle. Contact a PEUGEOT dealer or a qualified workshop.

#### **!** High-pressure washing

To avoid damaging the electrical components, it is expressly prohibited to use high-pressure washing in the engine compartment or under the body. Do not use a pressure greater than 80 bar when washing the bodywork.

### Traction battery

The 48 V Li-ion (Lithium-ion) traction battery stores the electrical energy needed to propel the vehicle.

The traction battery is automatically charged to ensure that the charge level is always around 50% of the maximum level, in order to fully exploit the hybrid functionality and, at the same

time, always have some capacity available for the energy recovery operation.

It is located under the front left seat.

The traction battery's range varies depending on the type of driving, the route and the ageing of its components.

**i** The traction battery ageing depends on several factors, such as climatic conditions and the distance travelled.

**!** To preserve the mileage of your vehicle and the durability of your traction battery, PEUGEOT recommends that you:

- Do not expose the vehicle to temperatures below  $-30^{\circ}\text{C}$  and above  $+60^{\circ}\text{C}$  for more than 24 hours.
- Do not use a generator to recharge your vehicle's traction battery.

#### **!** Vehicle in storage for more than 1 month

Always park the vehicle in a place with temperatures between  $-10^{\circ}\text{C}$  and  $+30^{\circ}\text{C}$  (parking in a place with extreme temperatures can damage the traction battery). Carry out the charging procedure for the traction battery (48V) via the accessory battery (12V) and the DC/DC converter. Refer to the **12 V battery/Accessory batteries** section for the charging the batteries using a battery charger procedure.

## Rechargeable hybrid or electric vehicles - Specific recommendations

These recommendations and specific information are only applicable to rechargeable hybrid and electric vehicles.

They introduce the control unit (mode 2) required to carry out the standard charging at home.

- ! This label is intended solely for use by firefighters and maintenance services in the event of any work on the vehicle. No other person must touch the device shown on this label.

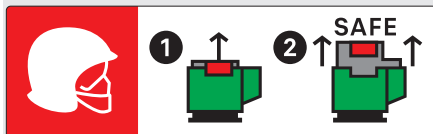

For rechargeable hybrid versions

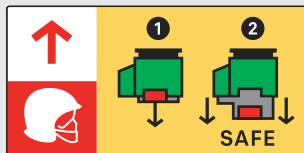

For electric versions

### ! In the event of an accident or impact to the vehicle's underbody

In these situations, the electrical circuit or the traction battery can be seriously damaged. Stop as soon as it is safe to do so and switch off the ignition. Contact a PEUGEOT dealer or a qualified workshop.

### ! Never allow water or dust to enter the connector or charging nozzle - risk of electrocution or fire!

Never connect / disconnect the charging nozzle or cable with wet hands - risk of electrocution!

### ! When washing

Before washing the vehicle, always check that the charging flap is closed correctly. Never wash the vehicle while the battery is on charge.

### ! High-pressure washing

To avoid damaging the electrical components, it is expressly prohibited to use high-pressure washing in the engine compartment or under the body. Do not use a pressure greater than 80 bar when washing the bodywork.

### ! To preserve the mileage of your vehicle and the durability of your traction battery,

PEUGEOT recommends that you:

- Do not fully charge the battery of your electric vehicle daily (charge the traction battery below 80% as often as possible).
- Do not completely discharge the battery.
- Do not store the vehicle for a long period of non-use (more than 12 hours) when the traction battery has a low or high charge level. Prefer a charge level between 20 and 40%.
- Limit the use of fast charging.
- Do not expose the vehicle to temperatures below -30°C and above +60°C for more than 24 hours.
- Avoid charging the vehicle at negative temperatures (except if the vehicle ran more than 20 minutes) or above +30°C.
- Do not use the vehicle's traction battery as a generator of energy.
- Do not use a generator to recharge your vehicle's traction battery.

## Precautions

Rechargeable hybrid or electric vehicles have been developed in accordance with the recommendations for maximum electromagnetic field limits established by the ICNIRP (International Commission on Non-Ionizing Radiation Protection - 1998 Guidelines).

**Wearers of pacemakers or equivalent devices**



If you are fitted with a pacemaker or similar device, consult your doctor or the electro-medical device's manufacturer about any precautions you should take or instructions you should follow and ensure that it is guaranteed to work in an environment which meets the recommendations of the ICNIRP.



#### In case of doubt

#### Domestic or accelerated charging

(mode 2 or 3): do not remain inside or near the vehicle, or near the charging cable or charging unit, even for a short time.

#### Superfast charging (mode 4 ; Electric):

do not use the system yourself and avoid approaching public fast charging points. Leave the area and ask a third party to recharge the vehicle.

## Control unit (mode 2)

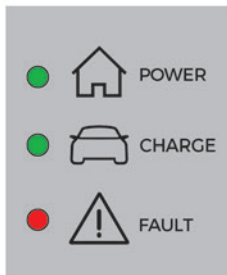
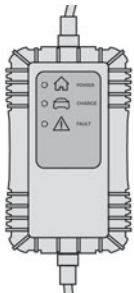

POWER

Green: electrical connection established; charging can begin.



#### CHARGE

Flashing green: charging in progress or temperature pre-conditioning activated.

Fixed green: charging complete.



#### FAULT

Red: fault; charging not permitted or must be stopped immediately. Check that everything is connected correctly and that the electrical system is not faulty.

If the indicator lamp does not go off, contact a PEUGEOT dealer or a qualified workshop. Upon plugging the charging cable into a domestic socket, all of the indicator lamps come on briefly.

If no indicator lamps come on, check the domestic socket's circuit-breaker:

– If the circuit-breaker has tripped, contact a professional to check that the electrical system is compatible and/or carry out any necessary repairs.

– If the circuit-breaker has not tripped, stop using the charging cable and contact a PEUGEOT dealer or a qualified workshop.

#### Control unit label - Recommendations



Refer to the handbook before use.



1. Incorrect use of this charging cable may result in fire, property damage and serious injury or death by electrocution!
2. Always use a correctly earthed power socket, protected by a 30 mA residual current device.
3. Always use an electrical socket protected by a circuit-breaker appropriate for the electrical circuit's current rating.
4. The weight of the control unit must not be borne by the electrical socket, plug and cables.
5. Never use this charging cable if it is defective or in any way damaged.
6. Never attempt to repair or open this charging cable. It contains no repairable parts - replace the charging cable if it is damaged.
7. Never immerse this charging cable in water.
8. Never use this charging cable with an extension cable, a multi-plug socket, a conversion adaptor or on a damaged electrical socket.
9. Do not unplug the plug from the wall as a means of stopping charging.
10. Immediately stop charging, by locking and then unlocking the vehicle using the remote control key, if the charging cable or wall socket feel burning hot to the touch.
11. This charging cable includes components liable to cause electrical arcing or sparks. Do not expose to flammable vapours.

12. Only use this charging cable with PEUGEOT vehicles.
13. Never plug the cable into the wall socket (or unplug it) with wet hands.
14. Do not force the connector if it is locked into the vehicle.









### Control unit label - State of indicator lamps

	State of the indicator lamp
Off	

	State of the indicator lamp
On	
Flashing	

POWER	CHARGE	FAULT	Symbol	Description
				Not connected to the power supply or power is not available from the infrastructure.
 (green)	 (green)	 (red)		The control unit is currently performing a self-test.
 (green)				Connected only to the infrastructure or to the infrastructure and to the Electric Vehicle (EV) but no charging in progress.
 (green)	 (green)			Connected to the power supply and to the Electric Vehicle (EV). The EV is on charge or in a temperature pre-conditioning sequence.
 (green)	 (green)			Connected to the power supply and to the Electric Vehicle (EV). The EV is waiting for charging or the charging of the EV is completed.



POWER	CHARGE	FAULT	Symbol	Description
		 (red)		Control unit malfunction. No charging allowed. If an error indicator reappears after a manual reset, the control unit must be checked by a PEUGEOT dealer before the next charge.
 (green)	 (green)	 (red)		The control unit is in diagnostic mode.

### Manual reset procedure

The control unit can be reset by simultaneously disconnecting the charging connector and the wall socket. Then, reconnect the wall socket first. For more information, refer to the handbook.

## Rechargeable hybrid system

### Electrical system

**!** For more information, refer to the **General recommendations on electrified vehicles** and the **Specific recommendations on rechargeable hybrid or electric vehicles**.

The electrical circuit of the rechargeable hybrid system is identified by orange cables and its components are marked with this symbol:



**!** The rechargeable hybrid powertrain uses a voltage of between 240 V and 400 V. This system may be hot both when the ignition is on and after switching it off. Comply with the warning messages shown on the labels, particularly inside the charging flap.

### Traction battery

The Li-ion (Lithium-ion) traction battery stores the electrical energy needed to propel the vehicle.

It is located in the boot.

The traction battery's range varies depending on the type of driving, the route, the use of thermal comfort equipment and the ageing of its components.

**i** The traction battery ageing depends on several factors, such as climatic conditions and the distance travelled.

## Charging flap

The charging flap is located on the rear left-hand side of the vehicle.

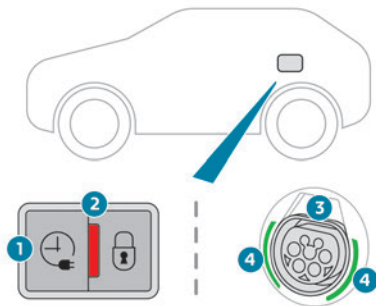

1. Deferred charging activation button
2. Indicator lamp confirming that the nozzle is locked into the charging connector.  
Fixed red: nozzle correctly positioned and locked.  
Flashing red: nozzle incorrectly positioned or locking not possible.
3. Charging connector
4. Light guides



Status of light guides	Meaning
Fixed white	Welcome lighting when flap is opened
Fixed blue	Deferred charging
Flashing green	Charging
Fixed green	Charging complete
Fixed red	Malfunction

**!** In case of impact, even light, against the charging flap, do not use it.  
Do not dismantle or modify the charging connector - risk of electrocution and/or fire!  
Contact a PEUGEOT dealer or a qualified workshop.

## Charging cables, sockets and chargers

The traction battery can be charged using several different types of cables.

The charging cable supplied with the vehicle is compatible with the electrical installations of the country of sale. If you are travelling abroad, refer to the following tables to check the compatibility of local electrical installations with the charging cable.



Contact a PEUGEOT dealer or a qualified workshop to obtain the appropriate charging cable(s).

## Identification labels on charging sockets/connectors

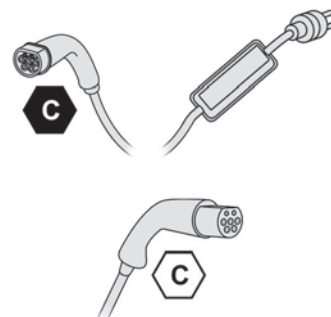

Identification labels are affixed to the vehicle, charging cable and charger to inform the user about which device needs to be used.



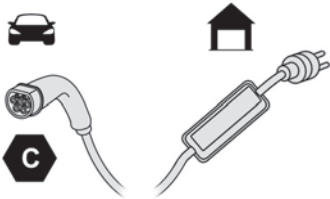
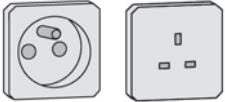

The meaning of each identification label is as follows:

Identification label	Location	Configuration	Power type/Voltage range
	Charging connector (vehicle side)	TYPE 2	AC < 480 Vrms
	Charging socket (charger side)	TYPE 2	AC < 480 Vrms

## Types of charging

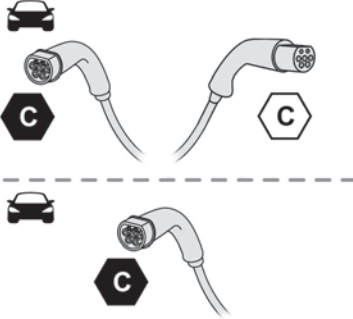
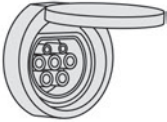
Cable type	Compatibility	Specifications
<p><b>Mode 2 charging cable with integrated control unit</b></p>  <p>Identification label <b>C</b> on the charging connector (vehicle side).</p>	<p>Conventional electrical socket (depending on country).</p> 	<p>Charge limited to a maximum of 10 A.</p>
	<p>"Green'Up" type socket.</p> 	<p>Charge limited to a maximum of 16 A.</p>

Cable type	Compatibility	Specifications
<p style="text-align: center;"><b>Mode 3 charging cable</b></p>  <p style="text-align: center;">Identification labels <b>C</b> on the charging connector (vehicle side) and on the socket (charger side).</p>	<p style="text-align: center;">Accelerated charging unit socket.</p>  <hr/> <p style="text-align: center;">Wallbox accelerated charging unit.</p> 	<p style="text-align: center;">Charge limited to a maximum of 32 A.</p>

**i** The estimated charging time is indicated on the instrument panel when the vehicle is connected. It may vary depending on various factors such as the outside temperature or the quality of the electricity supply.

If the outside temperature is below -10°C, it is recommended to connect the vehicle as soon as possible as the charging time may increase significantly. The traction battery may not charge fully.

**! Domestic charging cable (mode 2)**

It is essential to avoid damaging the cable and to keep it intact.

In the event of damage, do not use it and contact a PEUGEOT dealer or a qualified workshop to replace it.

**! Accelerated charging unit (mode 3)**

Do not dismantle or modify the accelerated charging unit - risk of electrocution and/or fire!

To find out how it is used, please refer to the accelerated charging unit's user instructions.

## Charging the traction battery (Rechargeable hybrid)

### Principle

**!** For more information, refer to the **General recommendations on electrified vehicles** and the **Specific recommendations on rechargeable hybrid or electric vehicles**.

For a full charge, follow the charging procedure without interrupting it, until it stops automatically. Charging may be performed either immediately (by default) or deferred.



Deferred charging is set via the touch screen or the **MYPEUGEOT APP** application.

When the vehicle is connected, the following information is displayed on the instrument panel:

- Traction battery charge status (%).
- Remaining range (miles or km).
- Estimated charging time (calculation may take a few seconds).
- Charging speed (miles or km gained per hour).

After the instrument panel has been put into standby mode, this information can be displayed again by unlocking the vehicle or opening a door.

**I** It is also possible to monitor the charging progress using the **MYPEUGEOT APP** application.

For more information on **Remotely operable additional functions**, refer to the corresponding section.

### **I Lounge mode**

When the vehicle is connected, it is possible to switch on the ignition and use certain functions such as the audio and telematics system and the air conditioning system for several hours.

### **! Low charging / Driving**

Driving when the charge level of the traction battery is too low can lead to the vehicle breaking down and can lead to accidents or serious injuries. **ALWAYS** make sure the traction battery has a sufficient charge level.

### **! Low charging / Parking**

If the outside temperature is negative, it is recommended not to park your vehicle outside for several hours at a low charging (less than 20%).

### **! Vehicle in storage for more than 1 month**

In the event of a long period of non-use of the vehicle (beyond 4 weeks) without the possibility of charging when restarting, the self-discharge may make it impossible to restart if the traction battery charge level is a low or very low, especially at negative ambient temperatures. **ALWAYS** make sure that the traction battery has a charge between 20% and 40% if you do not plan to use your vehicle for several weeks.

Do not connect the charging cable. Always park the vehicle in a place with temperatures between -10°C and 30°C (parking in a place with extreme temperatures can damage the traction battery).

Refer to the **12 V battery/Accessory batteries** section for the battery disconnection procedure.

## Precautions

### **! Before charging**

Depending on the context:

- ▶ Have a professional check that the electrical system to be used complies with applicable standards and is compatible with the vehicle.
- ▶ Have a professional electrician install a dedicated domestic power socket or accelerated charging unit (Wallbox) compatible with the vehicle. Use the charging cable supplied with the vehicle.

For more information, contact a PEUGEOT dealer or a qualified workshop.

### **! During charging**

As a safety measure, the engine will not start if the charging cable is plugged into the connector on the vehicle. A warning is displayed on the instrument panel. While charging is in progress, unlocking the vehicle will cause the charging to stop. If no action is taken on one of the openings (door or boot) or on the charging nozzle, the vehicle will lock again after 30 seconds and charging will resume automatically.

Never work under the bonnet:

- Some areas remain very hot, even an hour after charging ends - risk of burns!
- The fan may start at any time - risk of cuts or strangulation!

### ! After charging

Check that the charging flap is closed. Do not leave the cable connected to the domestic power socket - risk of short-circuit or electrocution in the event of contact with or immersion in water!

## Deferred charging

By default, the deferred charging start time is set to be around midnight.

Depending on equipment, this time can be changed.

### Settings

- ▶ In the **Energy** touch screen application, select the **Charging** tab.
- ▶ Set the charging start time.
- ▶ Press **OK**.

The setting is saved in the system.

- ▶ You can also programme the deferred charging function using a smartphone, via the **MYPEUGEOT APP** application.

For more information on **Remotely operable additional functions**, refer to the corresponding section.

### Activation

- ▶ After programming the deferred charging, connect the vehicle to the desired charging equipment.
- ▶ Press this button in the flap within one minute to activate the deferred charging (confirmed by the light guides coming on in blue).



## Charging procedure

### Connection

- ▶ Before charging, check that the gear selector is in mode **P** and the ignition is off, otherwise charging is impossible.
- ▶ Press on the rear of the charging flap to open it and check that there are no foreign bodies on the vehicle's charging connector. The light guides in the flap come on white.

### Domestic charging (mode 2)

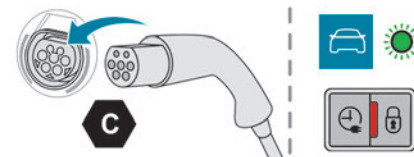
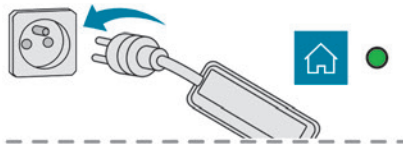

- ▶ First, connect the charging cable from the control unit to the domestic socket. When the connection is made, all of the indicator lamps on the control unit light up, then only the **POWER** indicator lamp remains on in green.
- ▶ Remove the protective cover from the charging nozzle.
- ▶ Insert the nozzle into the vehicle's charging connector. The start of charging is confirmed by the flashing of the green light guides in the flap and the flashing of the **CHARGE** indicator lamp in green on the control unit. If this is not the case, charging has not started; restart the procedure, ensuring that all of the connections are properly established. The red indicator lamp in the flap comes on to indicate that the nozzle is locked.

### Accelerated charging (mode 3)

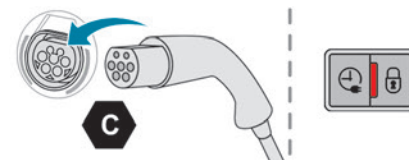

- ▶ Follow the accelerated charging unit (Wallbox) user instructions.
- ▶ Remove the protective cover from the charging nozzle.
- ▶ Insert the nozzle into the vehicle's charging connector.

The start of charging is confirmed by the flashing of the green light guides in the flap.

If this is not the case, charging has not started; restart the procedure ensuring that all connections are properly established.

The red indicator lamp in the flap comes on to indicate that the nozzle is locked.

### Disconnection



Before disconnecting the nozzle from the charging connector:

- ▶ If the vehicle is locked, unlock it.
- ▶ If the vehicle is unlocked, **lock it and then unlock it.**

**i** If selective unlocking of the doors is activated, press the unlocking button on the remote control twice to disconnect the nozzle.

The red indicator lamp in the flap goes out to confirm that the nozzle is unlocked.

- ▶ Within **30 seconds**, remove the charging nozzle.

### Domestic charging (mode 2)

The end of charging is confirmed when the green **CHARGE** indicator lamp on the control unit comes on fixed and the green light guides in the flap come on fixed.

- ▶ After disconnection, replace the protective cover over the nozzle and close the charging flap.
- ▶ Disconnect the control unit's charging cable from the domestic socket.

### Accelerated charging (mode 3)

The end of charging is confirmed by the accelerated charging unit (Wallbox) and when the green light guides in the flap come on fixed.

- ▶ After disconnection, replace the nozzle on to the charging unit and close the charging flap.

## Charging system (Electric)

### 400 V electrical system

**!** For more information, refer to the **General recommendations on electrified vehicles** and the **Specific recommendations on rechargeable hybrid or electric vehicles.**

The electric drive system, which operates at a voltage of approximately 400 V, is identified by orange cables and its components are marked with this symbol:



**!** An electric vehicle's power train can become hot during use and after switching off the ignition. Comply with the warning messages shown on the labels, particularly inside the charging flap.

## Traction battery

This battery stores the energy that powers the electric motor and the thermal comfort equipment in the passenger compartment. It is discharged during use, and must therefore be regularly recharged. There is no need to wait for the traction battery to fall to its reserve level before recharging.

The range of the battery may vary according to the type of driving, the route, the use of thermal comfort equipment and the ageing of its components.

**i** The lifespan of the traction battery depends on multiple factors, such as

climatic conditions, distance travelled and how often it has been fast-charged.

## Charging connectors and indicator lamps

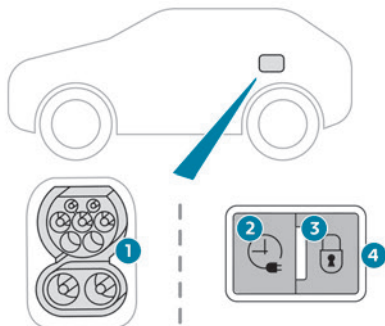

1. Charging connectors
2. Deferred charging activation button
3. Nozzle locking indicator lamp  
Fixed red: nozzle positioned correctly and locked in the connector.  
Flashing red: nozzle incorrectly positioned or locking not possible.
4. Charging indicator lamp



State of charging indicator lamp	Meaning
Fixed white	Welcome lighting on opening the flap and disconnecting the charging cable.
Flashing white	Charging initialisation.
Fixed blue	Deferred charging.
Flashing green	Charging.

State of charging indicator lamp	Meaning
Fixed green	Charging complete. The charging indicator lamp goes off after about 2 minutes as the vehicle's functions go into standby. The indicator lamp comes on again when the vehicle is unlocked with the Keyless Entry and Start system or when a door is opened to indicate that the battery is fully charged.
Fixed red	Malfunction.

**!** In case of impact, even light, against the charging flap, do not use it.  
Do not dismantle or modify the charging connector - risk of electrocution and/or fire!  
Contact a PEUGEOT dealer or a qualified workshop.



## Charging cables, sockets and chargers

The charging cable supplied with the vehicle (depending on version) is compatible with the electrical systems in the country of sale. When travelling abroad, check the compatibility of local electrical systems with the charging cable.

A full range of charging cables is available from your dealer.



Contact a PEUGEOT dealer or a qualified workshop for more information and to obtain suitable charging cables.

### Identification labels on charging sockets/connectors

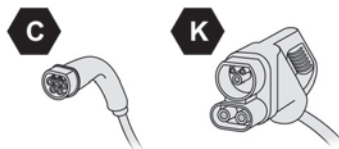
Identification labels are affixed to the vehicle, charging cable and charger to inform the user about which device needs to be used.



The meaning of each identification label is as follows:

Identification label	Location	Configuration	Power type/Voltage range
	Charging connector (vehicle side)	TYPE 2	AC < 480 Vrms
	Charging socket (charger side)	TYPE 2	AC < 480 Vrms
	Charging connector (vehicle side)	COMBO 2 (FF)	DC 50 V – 500 V

## Standard charging, mode 2

### Domestic socket

(standard charging - alternating current (AC))



Mode 2 with a standard socket: 8 A maximum charging current.



Mode 2 with a Green'Up socket: 16 A maximum charging current.

To have this type of socket installed, call a professional installer.

### Specific domestic charging cable - mode 2 (AC)

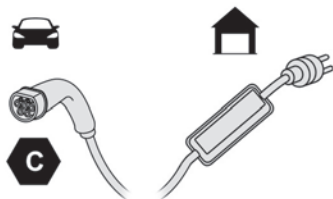

Identification label **C** on the charging connector (vehicle side).

### ! Specific domestic charging cable (mode 2)

You must not damage the cable. In the event of damage, do not use it and contact a PEUGEOT dealer or a qualified workshop to replace it.

## Accelerated charging, mode 3

### Accelerated charging unit (depending on version)

(accelerated charging - single-phase or three-phase alternating current (AC))

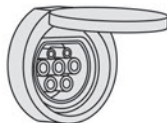

In mode 3 with an accelerated charging unit: 32 A maximum charging current.



In mode 3 with an accelerated charging unit (Wallbox): 32 A maximum charging current.

### Charging cable, mode 3 (AC)

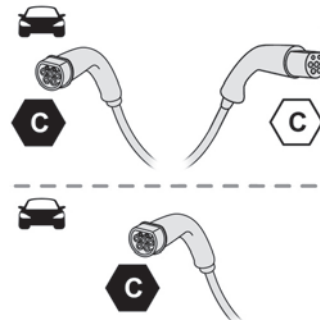

Identification labels **C** on the charging connector (vehicle side) and on the socket (charger side).

### ! Accelerated charging unit

Do not disassemble or modify the charging unit - Risk of electrocution and/or fire!

Refer to the charging unit manufacturer's user manual for the operating instructions.

## Superfast charging, mode 4

**Fast public charger**  
(superfast charging - direct current (DC))

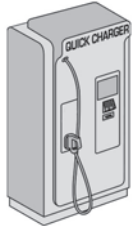

**Charging cable, mode 4 (DC)**  
(integrated into the fast public charger)

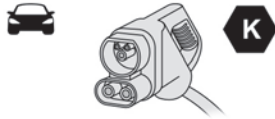

Identification label **K** on the charging connector (vehicle side).  
Only use fast public chargers where the cable length does not exceed 30 metres.

## Charging the traction battery (Electric)

### Principle

**!** For more information, refer to the **General recommendations on electrified vehicles** and the **Specific recommendations on rechargeable hybrid or electric vehicles**.

To recharge, connect the vehicle to a domestic electricity supply (domestic or accelerated charging) or to a fast public charger (superfast charging).

For a full charge, follow the desired charging procedure without pausing it, until it ends automatically. Charging can be either immediate or deferred (except fast public charger, mode 4).

You can stop domestic or accelerated charging at any time by unlocking the vehicle and removing the nozzle. For superfast charging, refer to the fast public charger.

For more information on the charging displays on the **Instrument panel** and the **Touch screen**, refer to the corresponding section.

**i** It is also possible to monitor the charging progress using the **MYPEUGEOT APP** application.

For more information on **Remotely operable additional functions**, refer to the corresponding section.

**!** As a safety measure, the engine will not start if the charging cable is plugged into the connector on the vehicle. A warning is displayed on the instrument panel.

**i** **Cooling the traction battery**  
The cooling fan in the engine compartment comes on during charging to cool the on-board charger and the traction battery.

**!** **Low charging / Driving**  
Driving when the charge level of the traction battery is too low can lead to the vehicle breaking down and can lead to accidents or serious injuries. **ALWAYS** make sure the traction battery has a sufficient charge level.

**!** **Low charging / Parking**  
If the outside temperature is negative, it is recommended not to park your vehicle outside for several hours at a low charging (less than 20%).

**!** **Vehicle in storage for more than 1 month**  
In the event of a long period of non-use of the vehicle (beyond 4 weeks) without the possibility of charging when restarting, the self-discharge may make it impossible to restart if the traction battery charge level

is a low or very low, especially at negative ambient temperatures. ALWAYS make sure that the traction battery has a charge between 20% and 40% if you do not plan to use your vehicle for several weeks.

Do not connect the charging cable.

Always park the vehicle in a place with temperatures between -10°C and 30°C (parking in a place with extreme temperatures can damage the traction battery).

Disconnect the cable from the (+) terminal of the accessory battery in the engine compartment.

Connect a 12 V battery charger to the (+) and (-) terminals of the accessory battery about every 3 months in order to recharge the accessory battery and maintain an operating voltage.

Refer to the **12 V battery/Accessory batteries** section for the battery disconnection procedure.

## Precautions

### For domestic or accelerated charging

#### Before charging

Depending on the context:

- ▶ Have a professional check that the electrical system to be used complies with applicable standards and is compatible with the vehicle.

- ▶ Have a professional electrician install a dedicated domestic power socket or accelerated charging unit (Wallbox) compatible with the vehicle. You should preferably use the charging cable available as an accessory. For more information, contact a PEUGEOT dealer or a qualified workshop.

#### During charging

- While charging is in progress, unlocking the vehicle will cause the charging to stop. If no action is taken on one of the openings (door or boot) or on the charging nozzle, the vehicle will lock again after 30 seconds and charging will resume automatically. Never work under the bonnet:
  - Some areas remain very hot, even an hour after charging ends - risk of burns!
  - The fan may start at any time - risk of cuts or strangulation!

#### After charging

- Check that the charging flap is closed. Do not leave the cable connected to the domestic power socket - risk of short-circuit or electrocution in the event of contact with or immersion in water!

## For superfast charging

#### Before charging

Check that the fast public charging station and its charging cable are compatible with the vehicle.

If the exterior temperature is below:

- 0°C, charging times may be extended.
- -20°C, charging is still possible, but charging times may be extended even further (the battery has to be heated first).

#### After charging

- Check that the charging flap is closed.

## Deferred charging

By default, the deferred charging start time is set to be around midnight.

Depending on equipment, this time can be changed.

### Settings



- ▶ In the **Energy** touch screen application, select the **Charging** tab.

- ▶ Set the charging start time.

- ▶ Press **OK**.

The setting is saved in the system.



You can also programme the deferred charging function using a smartphone, via the **MYPEUGEOT APP** application.

For more information on **Remotely operable additional functions**, refer to the corresponding section.

## Activation

**i** Deferred charging is only possible with modes 2 and 3.

► After programming the deferred charging, connect the vehicle to the desired charging equipment.



- Lock the vehicle.
- Press this button in the flap within one minute to activate the system (confirmed by the charging indicator lamp coming on in blue).

## Charging procedure

### Connection

- Before charging, check that the drive selector is in mode **P**, otherwise charging is not possible.
- Open the charging flap by pressing the push-button, and check that there are no foreign bodies on the charging connector.

### Domestic charging, mode 2

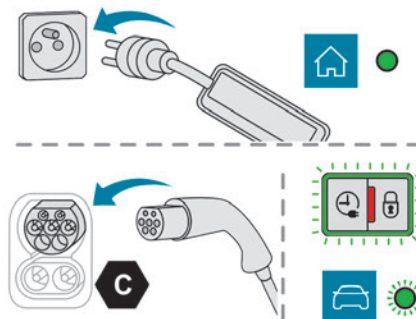

- Connect the charging cable from the control unit to the domestic socket. When the connection is made, all of the indicator lamps on the control unit light up, then only the **POWER** indicator lamp remains on in green.
- Remove the protective cover from the charging nozzle.
- Insert the nozzle into the charging connector. The start of charging is confirmed by the flashing green **CHARGE** indicator lamps in the flap, then those on the control unit.

If this is not the case, charging has not started; restart the procedure, ensuring that all connections are properly established. The red indicator lamp in the flap comes on to indicate that the nozzle is locked.

**i** When charging is complete and while the charging cable is still connected, opening

the driver's door will display the charge level on the instrument panel for about 20 seconds.

### Accelerated charging, mode 3



- Follow the accelerated charging unit (Wallbox) user instructions.
- Remove the protective cover from the charging nozzle.
- Insert the nozzle into the charging connector. The start of charging is confirmed when the charging indicator lamp in the flap flashes green. If this is not the case, charging has not started; restart the procedure, ensuring that the connection has been properly established. The red indicator lamp in the flap comes on to indicate that the nozzle is locked.

### Superfast charging, mode 4



- Depending on version, remove the protective cover from the lower part of the connector.

► Follow the instructions for use of the fast public charger and connect the cable from the fast public charger to the vehicle's connector. The start of charging is confirmed by the flashing green charging indicator lamp in the flap. If this is not the case, charging has not started; restart the procedure, ensuring that the connection is properly established. The red indicator lamp in the flap comes on to indicate that the nozzle is locked.

## Disconnection



Before disconnecting the nozzle from the charging connector:

► If the vehicle is unlocked, **lock it and then unlock it**.

► If the vehicle is locked, unlock it.

The red indicator lamp in the flap goes out to confirm that the charging nozzle is unlocked.

► In modes 2 and 3, remove the charging nozzle within **30 seconds**.

The charging indicator lamp comes on in white.

**i** With selective door unlocking activated, press the unlocking button twice to disconnect the charging nozzle.

**i** When charging is complete, the green charging indicator lamp in the flap goes out after about 2 minutes.

## Domestic charging, mode 2

The end of charging is confirmed when the green **CHARGE** indicator lamp on the control unit and the green charging indicator lamp in the flap come on fixed.

► Replace the protective cover on the charging nozzle and close the charging flap.

► Disconnect the control unit end of the charging cable from the domestic socket.

## Accelerated charging, mode 3

The end of charging is indicated by the charging control unit and by the fixed lighting of the green indicator lamp in the flap.

► Hang up the nozzle on the charging unit and close the charging flap.

## Superfast charging, mode 4

The end of charging is indicated by the charger and by the fixed lighting of the green indicator lamp in the flap.



► You can also pause charging by pressing this button in the flap (in mode 4 only).

► Hang up the nozzle on the charger.

► Depending on version, replace the protective cover on the lower section and close the charging flap.

**i** When the charging nozzle is disconnected, a message on the instrument panel indicates that charging is complete, even if the charging nozzle was disconnected before full charging was completed.

## Towing device

### Load distribution

► Distribute the load in the trailer so that the heaviest items are as close as possible to the axle, and the nose weight approaches the maximum permitted without exceeding it.

Air density decreases with altitude, thus reducing engine performance. The maximum towable load must be reduced by 10% per 1,000 metres of altitude.

**i** Use genuine towing devices and wiring harnesses approved by PEUGEOT. We recommend having them fitted by a PEUGEOT dealer or a qualified workshop. If not fitted by a PEUGEOT dealer, they must still be fitted in accordance with the vehicle manufacturer's instructions.

**Important:** if the vehicle has a motorised tailgate and Hands-Free Tailgate Access function, and a towing device has been fitted outside the PEUGEOT dealer network, it is essential to visit a PEUGEOT dealer or a qualified workshop to have the detection

system recalibrated - risk of malfunction of the Hands-Free Tailgate Access function. Certain driving or manoeuvring aid functions are automatically deactivated while an approved towing system is in use. For more information about driving with a towing device fitted to a trailer and associated with the **Trailer stability assist**, refer to the corresponding section.

**!** Comply with the maximum authorised towable weight, as indicated on your vehicle's registration certificate, on the manufacturer's label and in the **Technical data** section of this guide.

**!** If using accessories attached to the towing device (e.g. bicycle carriers, tow boxes):

- Comply with the maximum authorised nose weight.
- Do not transport more than 4 conventional bicycles or 2 electric bicycles.

When loading bicycles onto a bicycle carrier on a towball, be sure to place the heaviest bicycles as close as possible to the vehicle.

**!** Observe the legislation in force in the country where you are driving.

**!** **Vehicle equipped with motorised tailgate with hands-free function (Hands-Free Tailgate Access)**

To avoid unintentionally opening the motorised tailgate when operating the towing device:

- Deactivate this function in advance in the vehicle's configuration application.
- Or remove the electronic key from the recognition zone, with the tailgate closed.

**!** **Electric vehicles**

An electric vehicle may be fitted with a towing device.

However, it is not possible to tow a trailer or caravan.

The towing device should only be used for the installation of a bicycle carrier.

## Towing device with quickly detachable towball

### Presentation

No tools are required to install or remove this genuine towing device.

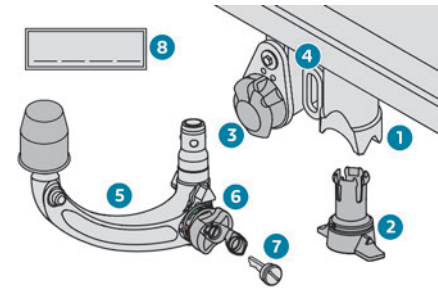

1. Carrier
2. Protective plug
3. Connection socket
4. Safety eye
5. Detachable towball
6. Locking/unlocking wheel
7. Security key lock
8. Label to note the key references

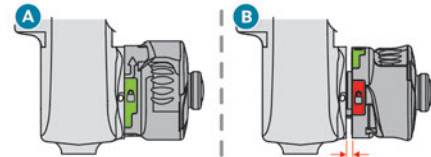

- A. Locked position** (**green** mark opposite the **white** mark); the wheel is in contact with the towball (no gap).
- B. Unlocked position** (**red** mark opposite the **white** mark); the wheel is no longer in contact with the towball (gap of around 5 mm).

**i** To ensure complete safety while driving with a **Towing device**, refer to the corresponding section.

**! Before each use**

Verify that the towball is correctly fitted, checking the follow points:

- The green mark on the wheel is aligned with the white mark on the towball.
- The wheel is in contact with the towball (position **A**).
- The security key lock is closed and the key removed; the wheel can no longer be operated.
- The towball must not be able to move in its carrier; test by attempting to shake it with your hand.

If the towball is not locked, the trailer can become detached - risk of an accident!

**! During use**

Never release the locking system with a trailer or load carrier on the towball.

Never exceed the maximum authorised weight for the vehicle - the Gross Train Weight or GTW.

Always comply with the maximum authorised load on the towing device: if it is exceeded, this device may become detached from the vehicle - risk of an accident!

Before driving, check the headlamp height adjustment and check that the lamps on the trailer operate correctly.

For more information on **Headlamp height adjustment**, refer to the corresponding section.

**! After use**

When travelling without a trailer or load carrier, remove the towball and fit the protective plug into the carrier, to provide clear visibility of the number plate and/or its lighting. Also, the connection socket must be tilted to the top position to avoid damaging the equipment while driving.

## Fitting the towball

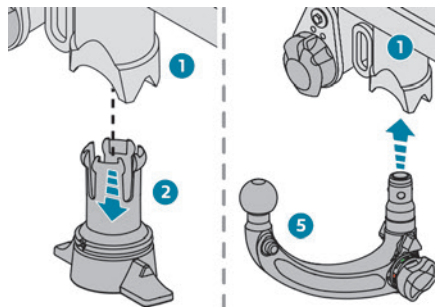

▶ Below the rear bumper, remove the protective plug **2** from the carrier **1**.

▶ Insert the end of the towball **5** into the carrier **1** and push it upwards; it will lock into position automatically.

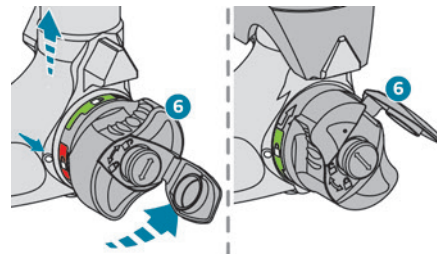

▶ The wheel **6** rotates a quarter turn anti-clockwise; take care to keep your hands clear!

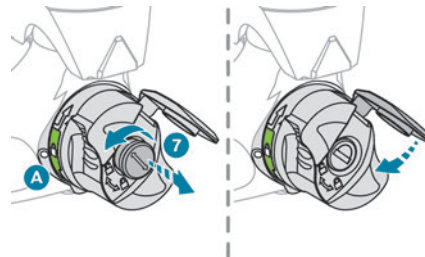

▶ Check that the mechanism has correctly locked into place and that the green mark on the wheel is aligned with the white mark on the towball (position **A**).

▶ Close the lock **7** using the key.

▶ Remove the key. The key cannot be removed while the lock is open.

▶ Lower the cap to protect the lock.



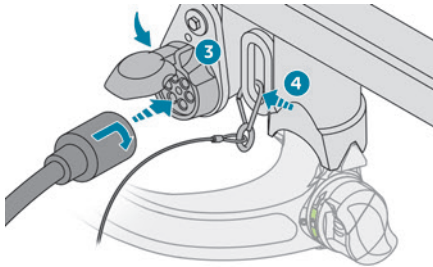

- ▶ Remove the protective cover from the towball.
- ▶ Attach the trailer to the towball.
- ▶ Attach the cable on the trailer to the safety eye 4 on the carrier.
- ▶ Lower the connection socket 3 to put it in position.
- ▶ Insert the trailer plug and rotate it by a quarter turn to connect it to the connection socket 3 on the carrier.

## Removing the towball

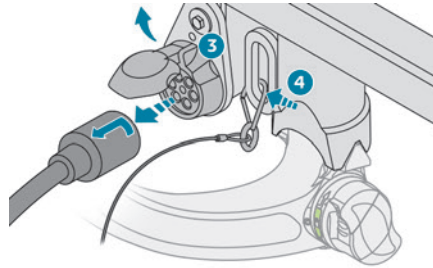

- ▶ Grasp the trailer's plug, perform a quarter turn and pull to disconnect it from the connection socket 3 on the carrier.
- ▶ Tilt the connection socket 3 to the top position to stow it away.
- ▶ Detach the trailer's safety cable from the safety eye 4 on the carrier.
- ▶ Unhitch the trailer from the towball.
- ▶ Replace the protective cover over the towball.

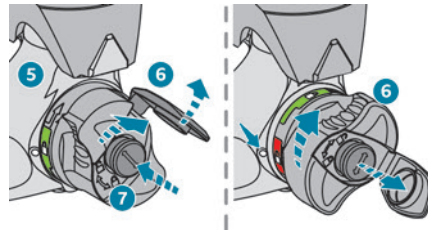

- ▶ Lift the cap to access the lock.
- ▶ Insert the key into the lock 7.
- ▶ Open the lock using the key.

- ▶ Hold the towball 5 firmly in one hand; using the other hand, pull and turn the wheel 6 fully in a clockwise direction until it stops; do not release the wheel.

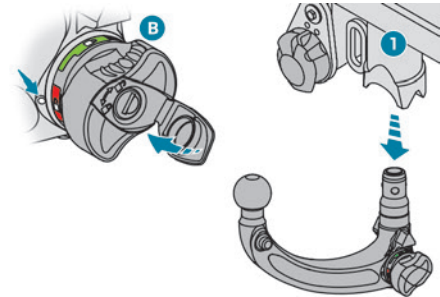

- ▶ Extract the towball from the base of its carrier 1.
- ▶ Release the wheel; it automatically locks in the unlocked position and the red mark on the wheel is in line with the white mark on the towball (position B).

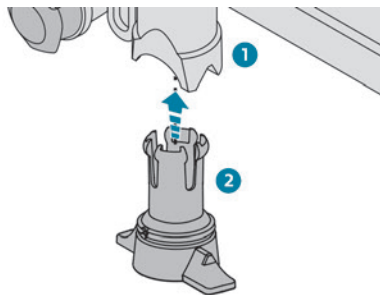

- Replace the protective plug **2** into the carrier **1**.
- Stow the towball in its bag to protect it from knocks and dirt.

## Storage

This procedure should be considered for versions without dedicated storage in the boot.

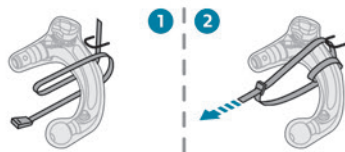
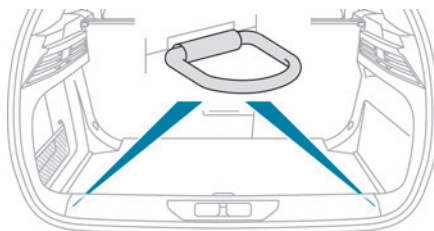

The towball is attached to boot ring with strap. 2 strap loops are made around the towball and then put into the ring.

## Maintenance

Correct operation is only possible if the towball and its carrier are kept clean. Before cleaning the vehicle with a high-pressure jet wash, the towball must be removed and the protective plug fitted to the carrier.

### **i** Work on the towing device

Contact a PEUGEOT dealer or a qualified workshop.

## Roof bars

**!** As a safety measure and to avoid damaging the roof, it is essential to use transverse roof bars approved for your vehicle. Observe the instructions on fitting and use contained in the guide supplied with the roof bars.

**!** Maximum load distributed over the transverse roof bars, for a loading height not exceeding 40 cm (except bicycle carrier): **80 kg**.

As this value may change, please verify the maximum load quoted in the guide supplied with the roof bars.

If the height exceeds 40 cm, adapt the speed of the vehicle to the profile of the road to avoid damaging the roof bars and the fixings on the vehicle.

Be sure to refer to national legislation in order to comply with the regulations for transporting objects that are longer than the vehicle.

## Direct fitting on roof

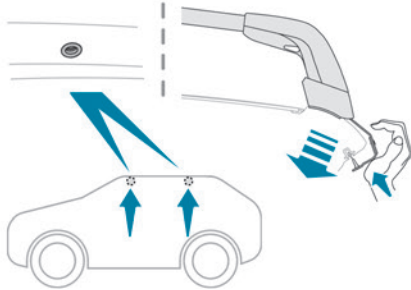

The transverse bars must only be fixed at the four anchorage points located on the roof frame. These points are concealed by the vehicle doors when the doors are closed.

The roof bar fixings have a stud which must be inserted into the opening of each anchorage point.

## Fitting on longitudinal bars (SW)

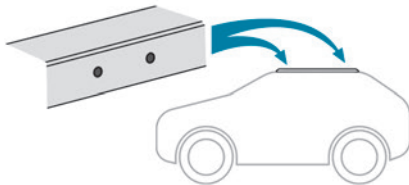

The transverse bars must be fixed at the markings located on the longitudinal bars.

### ! Recommendations

Distribute the load uniformly, taking care to avoid overloading one of the sides. Arrange the heaviest part of the load as close as possible to the roof. Secure the load firmly. Drive gently: the vehicle will be more susceptible to the effects of side winds and its stability may be affected. Regularly check the security and tight fastening of the roof bars, at least before each trip.

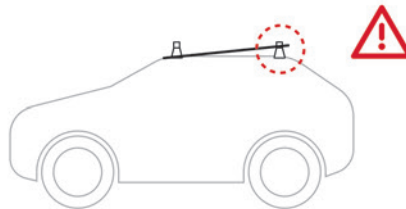

### ! Sunroof

Do not operate the sunroof when using roof bars - risk of major damage!

## Very cold climate screens

(Depending on country of sale)  
Only available for Diesel vehicles.

This removable device prevents the accumulation of snow around the radiator cooling fan.

It consists of two elements for the upper part of the front grille, a central element and two other elements for the lower part.

### i In case of difficulty with installation/removal

Contact a PEUGEOT dealer or a qualified workshop.

! Before any operation, ensure that the engine is off and the cooling fan has stopped.

! It is essential to remove them when:

- the outside temperature exceeds 10°C.
- recovery is in progress.
- the speed is above 75 mph (120 km/h).

## First installation

The type of grille depends on the vehicle version. The lower screens are suitable for all versions. The upper and centre screens can be adapted according to the vehicle version.

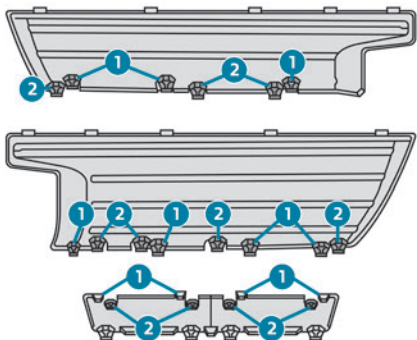

It is necessary to remove the fixings:

- Marked 2 for all versions except GT.
- Marked 1 for all GT versions.
- ▶ To remove the corresponding fixings, use a cutter-type tool, following the groove set into the inner face of the screen.

## Fitting

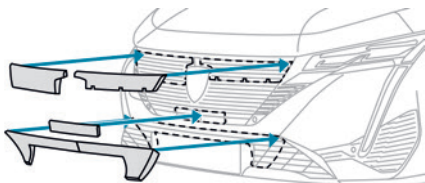

## Lower/upper screens

- ▶ Offer up one of the lower screens on the corresponding side of the lower bumper grille, aligning it around the number plate holder.
- ▶ Insert the fixing lugs into the bumper until they are all properly seated.
- ▶ Check that the unit is firmly held by pressing around the edges.

Repeat the same steps for the other lower screen, then for the upper screens in the upper bumper grille, aligning them with the top of the grille.

## Centre screen

- ▶ Offer up the centre screen below the brand badge.
- ▶ Insert the fixing lugs into the bumper until they are all properly seated.
- ▶ Check that the unit is firmly held by pressing around the edges.

## Removing

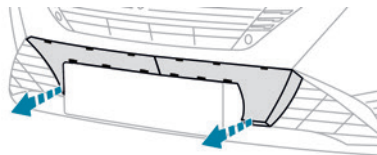

## For the lower screen

- ▶ Insert a finger in the lower outside corner of the lower screen.

- ▶ Pull towards you to guide the unclipping of the unit.

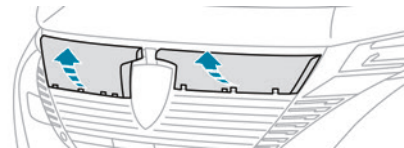

## For the upper screen

- ▶ Press on the lower fixing lugs to release them from the grille.
- ▶ Gently tilt the upper screen downwards.
- ▶ Pull towards you to guide the unclipping of the unit.

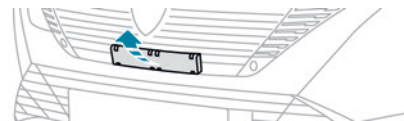

## For the centre screen

- ▶ Press on the upper fixing lugs to release them from the grille.
- ▶ Pull towards you to guide the unclipping of the unit.

## Snow chains

In wintry conditions, snow chains improve traction as well as the behaviour of the vehicle when braking.

**!** Snow chains must be fitted only to the front wheels.

They must never be fitted to "space-saver" type spare wheels.

**i** Observe the legislation in force in your country relating to the use of snow chains and maximum authorised speeds.

Only use chains that have been designed for the type of wheel fitted to your vehicle:

Original tyre size	Maximum link size
205/55 R16	9 mm
205/60 R16	9 mm
215/50 R17	9 mm
225/45 R17	9 mm
215/45 R18	9 mm
225/40 R18	Polaire PSGB 60

For more information, contact a PEUGEOT dealer or a qualified workshop.

## Installation tips

- ▶ To fit the snow chains during a journey, stop the vehicle on a flat surface at the side of the road.
- ▶ Apply the parking brake and position any wheel chocks under the wheels to prevent movement of the vehicle.

- ▶ Fit the snow chains following the instructions provided by the manufacturer.
- ▶ Move off gently and drive for a few moments, without exceeding 31 mph (50 km/h).
- ▶ Stop the vehicle and check that the snow chains are correctly tightened.

**i** It is strongly recommended that you practise fitting the snow chains on a level and dry surface before setting off.

**!** Avoid driving with snow chains on roads that have been cleared of snow to avoid damaging the vehicle's tyres and the road surface. If the vehicle is fitted with alloy wheels, check that no part of the chain or its fixings is in contact with the wheel rim.

## Energy economy mode

This system manages the duration of use of certain functions, in order to conserve a sufficient level of charge in the battery with the ignition off. After switching off the engine and for a maximum cumulative period of around 40 minutes, you can continue to use functions such as the audio and telematics system, dipped beam headlamps or courtesy lamps.

## Selecting the mode

A confirmation message is displayed when energy economy mode is entered, and the active functions are placed on standby.

**i** If a telephone call is in progress at the time, it will be maintained for around 10 minutes via the audio system's hands-free system.

## Exiting the mode

These functions are automatically reactivated the next time the vehicle is used.

To restore the use of these functions

immediately, start the engine and let it run:

- For less than 10 minutes, to use the equipment for approximately 5 minutes.
- For more than 10 minutes, to use the equipment for approximately 30 minutes.

Let the engine run for the specified duration to ensure that the battery charge is sufficient.

To recharge the battery, avoid repeatedly or continuously restarting the engine.

**!** A flat battery prevents the engine from starting.

For more information on the **12 V battery/ Accessories battery**, refer to the corresponding section.

## Load reduction mode

This system manages the use of certain functions according to the level of charge remaining in the battery.

When the vehicle is being driven, the load reduction function temporarily deactivates certain functions, such as the air conditioning and the heated rear screen.

The deactivated functions are reactivated automatically as soon as conditions permit.

## Bonnet

### ! Work in the engine compartment

Take care with objects or clothing that could be caught in the blades of the cooling fan or in certain moving components - risk of strangulation and serious injury!

**Petrol, Diesel or Hybrid vehicles (Stop & Start/e-Auto mode)**

Before doing anything under the bonnet, it is essential to switch off the ignition to avoid any risk of the engine restarting automatically.



### Rechargeable hybrid or electric vehicles

Before any work is carried out under the bonnet, it is essential to switch off the ignition, check that the **READY** indicator lamp is off on the instrument panel, disconnect the charging

connector nozzle if it is connected and wait for 4 minutes - risk of serious injury!



**i** The location of the interior bonnet release lever prevents the bonnet being opened when the left-hand front door is closed.

**!** When the engine is hot, handle the exterior safety catch and the bonnet stay with care (risk of burns), using the protected area.

When the bonnet is open, take care not to damage the safety catch. Do not open the bonnet under very windy conditions.

**!** **Cooling of the engine when stopped**  
**The engine cooling fan may start after the engine has been switched off.**  
**Take care with objects or clothing that could be caught in the blades of the fan!**

## Opening

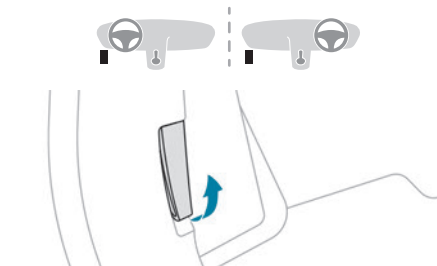

- ▶ Open the left-hand front door.
- ▶ Pull the interior release lever, located at the bottom of the door frame, towards you.

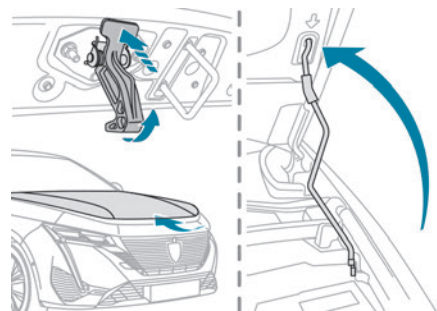

- ▶ Lift the exterior safety catch and raise the bonnet.
- ▶ Unclip the stay from its housing and place it in the support slot to hold the bonnet open.

## Closing

- ▶ Lower the bonnet and release it near the end of its travel.
- ▶ Check the locking.

**!** Because of the presence of electrical equipment under the bonnet, it is strongly recommended that exposure to water (rain, washing, etc.) be limited.

## Engine compartment

The engine shown here is an example for illustrative purposes only.

The locations of the following components may vary:

- Air filter.
- Engine oil dipstick.
- Engine oil filler cap.

### Petrol engine

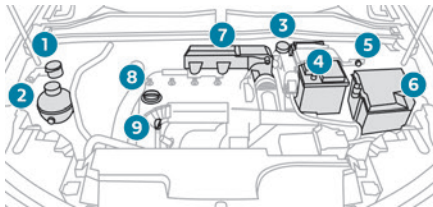

### Diesel engine

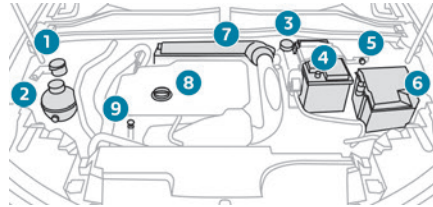

1. Screenwash fluid reservoir
2. Engine coolant reservoir
3. Brake fluid reservoir
4. Battery/Fuses
5. Remote earth point (-)
6. Fusebox
7. Air filter
8. Engine oil filler cap
9. Engine oil dipstick

### **!** Diesel fuel system

This system is under very high pressure. All work must be carried out only by a PEUGEOT dealer or a qualified workshop

### Electric engine

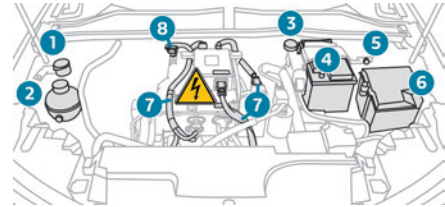

1. Screenwash fluid reservoir
2. Engine coolant reservoir (level only)
3. Brake fluid reservoir
4. Battery/Fuses
5. Remote earth point (-)
6. Fusebox
7. 400 V electrical circuit
8. Emergency circuit-breaker for emergency services and maintenance technicians

For more information on the **Charging system (Electric)**, refer to the corresponding section.

## Checking levels

Check all of the following levels regularly in accordance with the Manufacturer's service schedule. Top them up if required, unless otherwise indicated.

If a level drops significantly, have the corresponding system checked by a PEUGEOT dealer or a qualified workshop.

**!** The fluids must comply with the Manufacturer's requirements and with the vehicle's engine.

**!** Take care when working under the bonnet, as certain areas of the engine may be extremely hot (risk of burns) and the cooling fan could start at any time (even with the ignition off).

## Used products

**!** Avoid prolonged contact of used oil or fluids with the skin.

Most of these fluids are harmful to health and very corrosive.



Do not discard used oil or fluids into sewers or onto the ground.

Empty used oil into the containers reserved for this purpose at a PEUGEOT dealer or a qualified workshop.

## Engine oil



The level is checked, with the engine having been switched off for at least 30 minutes and on level ground, either using the oil level indicator in the instrument panel when the ignition is switched on (for vehicles equipped with an electric gauge), or using the dipstick.

It is normal to top up the oil level between two services (or oil changes). It is recommended that you check the level, and top up if necessary, every 3,000 miles (5,000 km).

**!** In order to maintain the reliability of the engine and emissions control system, never use additives in the engine oil.

### Checking using the dipstick

For the location of the dipstick, please refer to the illustration of the corresponding engine compartment.

- ▶ Grasp the dipstick by its coloured grip and pull it out completely.
- ▶ Wipe the end of the dipstick using a clean, lint-free cloth.

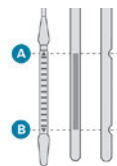

- ▶ Reinsert the dipstick and push fully down, then pull it out again to visually check the oil level: the correct level is between marks **A (max)** and **B (min)**.

#### Do not start the engine if the level is:

- above mark **A**: contact a PEUGEOT dealer or a qualified workshop.
- below mark **B**: top up the engine oil immediately.

### Oil grade

**!** Before topping up or changing the engine oil, check that the oil is suitable for your engine and complies with the recommendations in the service schedule supplied with the vehicle (or available from your PEUGEOT dealer or qualified workshop).

Use of non-recommended oil may invalidate your warranty in the event of engine failure.

### Topping up the engine oil level

For the location of the engine oil filler cap, please refer to the corresponding engine compartment illustration.

- ▶ Add oil in small quantities, avoiding any spills on engine components (risk of fire).
- ▶ Wait a few minutes before checking the level again using the dipstick.
- ▶ Top up the level if necessary.
- ▶ After checking the level, carefully screw the oil filler cap back on and replace the dipstick in its tube.

**i** The oil level indication displayed on the instrument panel when the ignition is switched on is not valid for 30 minutes following an addition of oil.



## Brake fluid



The level of this fluid should be close to the **"MAX"** mark. If not, check the brake pads for wear.

To know how often the brake fluid should be replaced, refer to the manufacturer's servicing schedule.



Clean the cap before removing it to refill. Use only DOT4 brake fluid from a sealed container.

## Engine coolant

For petrol, Diesel, hybrid or rechargeable hybrid versions



It is normal to top up this fluid between two services.

The check and top-up must only be done with the engine cold.

A level of coolant that is too low risks causing major damage to the engine; the coolant level must be close to the **"MAX"** mark without ever going above it.

If the level is close to or below the **"MIN"** mark, it is essential to top it up.

When the engine is hot, the temperature of the coolant is regulated by the fan.

As the cooling system is pressurised, wait at least one hour after switching off the engine before carrying out any work.

In order to avoid the risk of scalding if you need to top up in an emergency, wrap a cloth around

the cap and unscrew the cap by two turns to allow the pressure to drop.

Once the pressure has dropped, remove the cap and top up to the required level.

**!** For electric versions  
Do not top up the coolant.



If the level is close to or below the **"MIN"** mark, it is essential to contact a PEUGEOT dealer or a qualified workshop.

## Screenwash fluid



Top up to the required level when necessary.

## Fluid specification

The fluid must be topped up with a pre-mixed product.

In winter (temperatures below zero), a fluid containing an anti-freeze agent which is appropriate for the temperature conditions must be used in order to protect the system's components (pump, tank, ducts, jets).



Filling with pure water is prohibited in all circumstances (risk of freezing, limescale, etc.).

## Diesel fuel additive (Diesel with particle filter)



On reaching the minimum level in the particle filter additive tank, this warning lamp comes on fixed, accompanied by an audible signal and a warning message.

## Topping up

The topping up of this additive must be carried out quickly.

Go to a PEUGEOT dealer or a qualified workshop.

## AdBlue® (BlueHDi)

An alert is triggered when the reserve level is reached.

For more information on the **Indicators** and in particular the AdBlue range indicators, refer to the corresponding section.

To avoid the vehicle being immobilised in accordance with regulations, you must top up the AdBlue tank.

For more information on **AdBlue® (BlueHDi)**, and in particular the supply of AdBlue, refer to the corresponding section.

## Checks

Unless otherwise indicated, check these components in accordance with the Manufacturer's service schedule and according to your engine.

Otherwise, have them checked by a PEUGEOT dealer or a qualified workshop.

**!** Only use products recommended by PEUGEOT or products of equivalent quality and specification. In order to optimise the operation of components as important as those in the braking system, PEUGEOT selects and offers very specific products.

## 12 V battery



The battery does not require any maintenance.

Check regularly that the terminals are correctly tightened (versions without quick-release terminals) and that the connections are clean.

**i** For more information on the precautions to take before any work on the **12 V battery**, refer to the corresponding section.

**!** Versions equipped with Stop & Start are fitted with a 12 V lead-acid battery with special technology and specifications. Its replacement should be carried out only by a PEUGEOT dealer or a qualified workshop.

## Passenger compartment filter



Depending on the environment and the use of the vehicle (e.g. dusty atmosphere,

city driving), **change it twice as often, if necessary.**

**i** A clogged passenger compartment filter can adversely affect air conditioning system performance and generate undesirable odours.

## Air filter



Depending on the environment and the use of the vehicle (e.g. dusty atmosphere, city driving), **change it twice as often, if necessary.**

## Oil filter



Change the oil filter each time the engine oil is changed.

## Particle filter (Diesel)



The start of clogging of the particle filter is indicated by the temporary lighting of this warning lamp, accompanied by an alert message.

As soon as traffic conditions allow, regenerate the filter by driving at a speed of at least 37 mph (60 km/h), with an engine speed above 2,500 rpm, for about 15 minutes (until the warning lamp goes out).

If it is not possible to reach 37 mph (60 km/h), leave the engine running at idle for about 15 minutes, then drive with an engine speed above 2,500 rpm for 15 minutes.

**!** Do not switch off the engine until the filter is fully regenerated; repeated intervals can degrade the engine oil prematurely. Regenerating the filter while the vehicle is stationary is not recommended.

**i** Following prolonged operation of the vehicle at very low speed or at idle, you may, in exceptional circumstances, notice water vapour coming from the exhaust while accelerating. These emissions have no impact on the vehicle's behaviour and the environment.

**i** **New vehicle**  
During the first few particle filter regeneration operations, you may notice a "burning" smell. This is perfectly normal.

## Manual gearbox



The gearbox does not require any maintenance (no oil change).

## Automatic gearbox



The gearbox does not require any maintenance (no oil change).

## Brake pads



Brake wear depends on the style of driving, particularly in the case of vehicles used in town, over short distances. It may be

necessary to have the condition of the brakes checked, even between vehicle services. Unless there is a leak in the circuit, a drop in the brake fluid level indicates that the brake pads are worn.

**i** After washing the vehicle, moisture, or in wintry conditions, ice can form on the brake discs and pads: braking efficiency may be reduced. Gently dab the brakes to dry and defrost them.

## Brake disc wear



For information on checking brake disc wear, contact a PEUGEOT dealer or a qualified workshop.

## Electric parking brake



This system does not require any routine servicing. However, in the event of a problem, do not hesitate to have the system checked by a PEUGEOT dealer or a qualified workshop.

**i** For more information on the **Electric parking brake**, refer to the corresponding section.

## Wheels and tyres



The inflation pressure of all tyres, including the spare wheel, must be checked on "cold" tyres.

The pressures indicated on the tyre pressure label are valid for "cold" tyres. If you have driven for more than 10 minutes or more than 6 miles (10 kilometres) at over 31 mph (50 km/h), add 0.3 bar (30 kPa) to the values indicated on the label.

**!** Under-inflation increases energy consumption. Non-compliant tyre pressures cause tyres to wear prematurely and have an adverse effect on the vehicle's road holding - risk of accident!

Driving with worn or damaged tyres reduces the braking and road holding performance of the vehicle. Regularly check the condition of the tyres (tread and sidewalls) and rims as well as the presence of the valve caps.

When the wear indicators no longer appear set back from the tread, the depth of the grooves is less than 1.6 mm; replace the tyres as soon as possible.

Using different size wheels and tyres from those specified can affect the lifetime of tyres, wheel rotation, ground clearance, the speedometer reading and have an adverse effect on road holding.

Fitting different tyres on the front and rear axles can cause the ESC to mistime.

Always mark the direction of rotation on the tyres that will be stored when fitting winter or summer tyres. Store them in a cool, dry place and away from direct exposure to the sun's rays.



Winter or 4-seasons tyres can be identified by this symbol on their sidewalls.

## Shock absorbers



It is not easy for drivers to detect when shock absorbers are worn. Nevertheless, the shock absorbers have a major impact on road holding and braking performance. For your safety and driving comfort, it is important to have them regularly checked by a PEUGEOT dealer or a qualified workshop.

## Timing and accessory kits



The timing and accessory kits are used from the time the engine is started until it is switched off. It is normal for them to wear over time.

A faulty timing or accessory kit can damage the engine, rendering it unusable. Observe the recommended replacement frequency, stated in distance travelled or time elapsed, whichever is reached first.

## AdBlue® (BlueHDi)

To respect the environment and ensure compliance with the Euro 6 standard, without adversely affecting the performance or fuel consumption of its Diesel engines, PEUGEOT has taken the decision to equip its vehicles with a system that combines SCR (Selective Catalytic

Reduction) with a Diesel Particle Filter (DPF) for the treatment of exhaust gases.

## SCR system

Using a liquid called AdBlue® that contains urea, a catalytic converter turns up to 85% of the nitrogen oxides (NOx) into nitrogen and water, which are harmless to health and the environment.



The AdBlue® is contained in a **special tank** holding about 15 litres.

Its capacity allows a driving range of approximately 3,900 miles (6,500 km), **which may vary considerably** depending on your driving style.

An alert system is triggered once the reserve level is reached: it is then possible to drive for a further 1,500 miles (2,400 km) before the tank is empty and the vehicle is immobilised.

**I** For more information on the **Warning and indicator lamps** and the associated alerts, or the **Indicators**, please refer to the corresponding sections.

**!** Once the AdBlue® tank is empty, a device required by law prevents the engine from being restarted.  
If the SCR system is faulty, the level of emissions from the vehicle will no longer meet the Euro 6 standard and the vehicle starts polluting the environment.

In the event of a confirmed SCR system malfunction, it is essential to visit a PEUGEOT dealer or a qualified workshop. After 685 miles (1,100 km), a device is automatically activated to prevent the engine from starting.  
In both cases, a range indicator indicates the distance that can be travelled before the vehicle is stopped.

**I** **Freezing of the AdBlue®**  
AdBlue® freezes at temperatures below around -11°C.  
The SCR system includes a heater for the AdBlue® tank, allowing you to continue driving in very cold conditions.

## Supply of AdBlue®

It is recommended that the AdBlue® be topped up as soon as the first alert is issued indicating that the reserve level has been reached.

- !** For the correct operation of the SCR system:
- Use only AdBlue® fluid that meets the ISO 22241 standard.
  - Never transfer AdBlue® to another container as it would lose its purity.
  - Never dilute AdBlue® with water.

You can obtain AdBlue® from a PEUGEOT dealer or a qualified workshop, as well as service

stations equipped with AdBlue® pumps specially designed for passenger vehicles.

## Recommendations on storage

AdBlue® freezes at about -11°C and deteriorates above +25°C. Containers should be stored in a cool area and protected from direct sunlight. Under these conditions, the fluid can be kept for at least a year.

If the fluid has frozen, it can be used once it has completely thawed out at room temperature.

**!** Never store AdBlue® containers in your vehicle.

## Precautions for use

AdBlue® is a urea-based solution. This fluid is non-flammable, colourless and odourless (when kept in a cool place).

In the event of contact with the skin, wash the affected area with soap and running water. In the event of contact with the eyes, immediately rinse the eyes with large amounts of water or with an eye wash solution for at least 15 minutes. Seek medical attention if you feel a persistent burning sensation or irritation.

If swallowed, immediately wash out the mouth with clean water and then drink plenty of water. In certain conditions (high temperature, for example), the risk of release of ammonia cannot be excluded: do not inhale the fluid. Ammonia vapours have an irritant effect on mucous membranes (eyes, nose and throat).

- ! Store AdBlue® out of the reach of children, in its original container.

## Procedure

Before starting the top-up procedure, ensure that the vehicle is parked on a flat and level surface. In wintry conditions, ensure that the temperature of the vehicle is above -11°C. Otherwise the AdBlue® may be frozen and so cannot be poured into the tank. Park the vehicle in a warmer area for a few hours to allow the top-up to be carried out.

- ! Never pour the AdBlue® into the Diesel fuel tank.

! If any AdBlue® is splashed, or if there are any spillages on the bodywork, rinse immediately with cold water or wipe with a damp cloth. If the fluid has crystallised, clean it off using a sponge and hot water.

! Important: **in the event of a top-up after an AdBlue breakdown**, you must wait about 5 minutes before switching on the ignition, **without opening the driver's door, unlocking the vehicle or bringing the electronic key into the passenger compartment.**

Switch on the ignition, then wait for 10 seconds before starting the engine.

- ▶ Press the "START/STOP" button to switch off the engine.

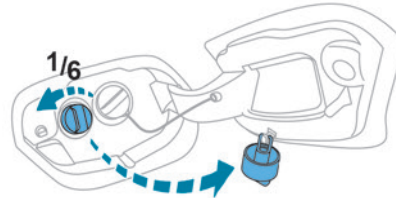

- ▶ Turn the blue cap of the AdBlue® tank anti-clockwise and remove it.
- ▶ With a container of AdBlue®: after checking the expiry date, read the instructions on the label carefully before pouring the contents of the container into the vehicle's AdBlue® tank.
- ▶ With an AdBlue® pump: insert the nozzle and fill the tank until the nozzle automatically cuts out.

! In order not to overfill the AdBlue® tank:  
 – Add between 10 and 13 litres using AdBlue® containers.  
 – Stop after the nozzle's first automatic cut-out, if you are refilling at a service station. The system only registers AdBlue® intermediate top-ups of 5 litres or more.

- ! If the AdBlue® tank is completely empty  
 – which is confirmed by the message

"Top up AdBlue: Starting impossible" – it is essential to add at least 10 litres. Top-up detection may not be instantaneous after addition. It may take a few minutes of driving before the top-up detection is effective.

## Free-wheeling

In certain situations, it is necessary to put the vehicle into free-wheeling mode (e.g. towing, on a rolling road, automatic car wash (Wash mode), rail or sea transport).

The procedure varies according to the type of gearbox and parking brake.

- ! Never leave the vehicle unattended with the vehicle into free-wheeling mode.

## With a manual gearbox and electric parking brake



### To release them

- ▶ With the engine running and while depressing the brake pedal, move the gear selector to the neutral position.
- ▶ While depressing the brake pedal, switch off the ignition.
- ▶ Release the brake pedal, then switch on the ignition again.

- ▶ While depressing the brake pedal, press the control lever to release the parking brake.
- ▶ Release the brake pedal, then switch off the ignition.

### Reverting to normal operation

- ▶ While depressing the brake pedal, restart the engine.

## With automatic gearbox or drive selector and electric parking brake



### Release procedure

With the vehicle stationary and the engine running:

- ▶ Depress and hold the brake pedal.
- ▶ Select and hold the mode **N** on the push selector.
- ▶ Press the **START/STOP** button around 1 s to switch off the engine (confirmed by the flashing of the **P** and **N** indicator lights).
- ▶ Release the brake pedal to switch on the ignition and deactivate the electric parking brake.

**!** A message is displayed on the instrument panel to confirm the unlocking of the wheels for 15 minutes. When the vehicle is free-wheeling, the audio system cannot be updated (message displayed on the instrument panel).

### After 15 minutes or reverting to normal operation

- ▶ While depressing the brake pedal, restart the engine and select mode **P**.

#### **i** Keyless Entry and Start

You must not depress the brake pedal while switching the ignition on again, then switching it off. If you do, the engine will start, requiring you to restart the procedure.

## Advice on care and maintenance

### General recommendations

Observe the following recommendations to avoid damaging the vehicle.

#### Exterior

**!** Never use a high-pressure jet wash in the engine compartment - risk of damaging the electrical components! Do not wash the vehicle in bright sunshine or extremely cold conditions.

**i** When washing the vehicle in an automatic roller-brush car wash, be sure to lock the doors and, depending on version, move the electronic key away and deactivate

the "hands-free" function (Hands-Free Tailgate Access).

When using a pressure washer, keep the jet nozzle at a minimum distance of 30 cm from the vehicle (particularly when cleaning areas containing chipped paint, sensors or seals). Promptly clean up any stains containing chemicals liable to damage the vehicle's paintwork (including tree resin, bird droppings, insect secretions, pollen and tar). Depending on the environment, clean the vehicle frequently to remove salty deposits (in coastal areas), soot (in industrial areas) and mud/salts (in wet or cold areas). These substances can be highly corrosive.

Contact a PEUGEOT dealer or a qualified workshop for advice on removing stubborn stains requiring special products (such as tar or insect removers).

Preferably, have paint touch-ups performed by a PEUGEOT dealer or a qualified workshop.

#### Interior

**!** When washing the vehicle, never use a water hose or high-pressure jet to clean the interior.

Liquids carried in cups or other open containers can spill, presenting a risk of damage to the instruments and controls and the controls located on the centre console. Be vigilant!

To clean instrument panels, touch screens or other displays, wipe gently with a soft, dry cloth. Do not use products (e.g. alcohol, disinfectant) or soapy water directly on these surfaces - risk of damage!

## Bodywork

### High-gloss paint

**!** Do not use abrasive products, solvents, petrol or oil to clean the bodywork.

Never use an abrasive sponge to clean stubborn stains - risk of scratching the paintwork!

Do not apply polish in strong sunshine, or to plastic or rubber parts.

**i** Use a soft cloth and soapy water or a pH neutral product.

Gently wipe the bodywork with a clean microfibre cloth.

Apply polish with the vehicle clean and dry. Comply with the instructions for use stated on the product.

### Decals

(Depending on version)

**!** Do not use a high-pressure washer to clean the vehicle - risk of damaging or detaching the decals!

**i** Use a high-flow hose (temperature between 25°C and 40°C).

Place the jet of water perpendicular to the surface to be cleaned.

Rinse the vehicle with demineralised water.

## Textile

The dashboard, door panels and seats may contain parts made of textile material.

### Maintenance

**!** Do not use aggressive cleaning products (e.g. alcohol, solvent or ammonia).

Do not use steam-cleaning systems - risk of affecting the adhesion of the fabrics!

**i** Remove dust from the textile parts regularly with a dry cloth, soft brush or vacuum cleaner.

Rub down the textile parts once per year with a clean, damp cloth. After leaving overnight to dry, brush with a soft-bristled brush.

### Stain removal

**!** Do not rub the stain or it may spread or you may cause the substance to penetrate the surface.

**i** Act quickly by reducing the stain from its edges inwards.

Remove as much substance or solids as possible using a spoon or spatula, and remove as much liquid as possible using absorbent paper.

**i** **Product/Procedure to use depending on the type of stain:**

- Grease, oil and ink: clean with a pH-neutral detergent.
  - Vomit: clean with sparkling mineral water.
  - Blood: spread flour over the stain and allow to dry; remove with a slightly damp cloth.
  - Mud: allow to dry and then remove with a slightly damp cloth.
  - Cake, chocolate, ice cream: clean with lukewarm water.
  - Sugary and/or alcoholic drinks: clean with lukewarm water, or lemon juice if the stain is persistent.
  - Hair gel, coffee, tomato sauce, vinegar: clean with lukewarm water and lemon juice.
- For solid substances, then use a soft brush or vacuum cleaner.
- For liquid substances, then use a damp microfibre cloth and then dry with another cloth.

## Alcantara®

Alcantara® is an elegant and practical material which is very resistant and easy to maintain.

**!** Do not use printed cloths or printed absorbent paper.

Do not use steam-cleaning systems.

**i** Remove dust from the Alcantara® parts regularly with a dry cloth, soft brush or vacuum cleaner.

Clean the Alcantara®, without rubbing too vigorously, with a white cotton cloth which is slightly damp.

To find out which products and procedures to use on different types of stains, refer to the **"Textile - Stain removal"** section.

For more information, go to the Alcantara® trademark website: [www.alcantara.com](http://www.alcantara.com).

## Leather

Leather is a natural product. Appropriate regular care is essential for its durability.

It must be protected and nourished using a specific leather product, to keep it supple and preserve its original appearance.

**!** Do not use maintenance products which are not suitable for cleaning leather (e.g. solvent, detergent, petrol, pure alcohol).

Do not use bleaching or colour-removal products (e.g. perchloroethylene).

When cleaning items partly made from leather, take care not to damage the other materials with the specific leather product.

**i** Before cleaning greasy stains or liquids, quickly mop up any surplus.

Before cleaning, wipe off any residues liable to scuff the leather, using a cloth that has been dampened with demineralised water and thoroughly wrung out.

Clean the leather, without rubbing too vigorously, using a soft cloth moistened with soapy water or a pH-neutral product.

Dry with a soft, dry cloth.



## Warning triangle

This reflective and dismantable device is to be installed on the side of the road when a vehicle is broken down or damaged.

### ! Before getting out of the vehicle

Turn on the hazard warning lamps, then put on the safety vest to assemble and install the triangle.

## Storage

### Hatchback

A compartment is provided in the storage box, located under the boot carpet.

### SW

A compartment is provided in the interior trim of the tailgate.

## Assembling and placing the triangle

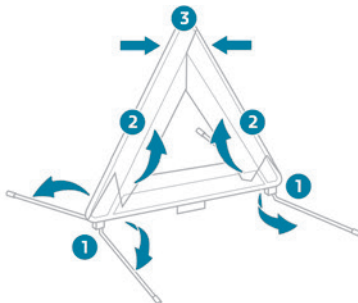

For versions supplied with a triangle as original equipment, refer to the illustration above.

For other versions, refer to the assembly instructions provided with the triangle.

► Put the triangle in place behind the vehicle, as required by local legislation.

## Running out of fuel (Diesel)

With Diesel engines, the fuel system must be primed if you run out of fuel.

**Before starting to prime the system**, it is essential to put at least 5 litres of Diesel into the fuel tank.

**i** For more information on **Refuelling** and on **Misfuel prevention (Diesel)**, refer to the corresponding section.

- Switch on the ignition (without starting the engine).
- Wait around 1 minute and switch off the ignition.
- Operate the starter motor to start the engine. If the engine does not start at the first attempt, do not keep trying, but restart the procedure.

## Tool kit

Set of tools supplied with the vehicle.

Its content depends on your vehicle's equipment:

- Temporary puncture repair kit.
- Spare wheel.

**!** These tools are specific to the vehicle and may vary according to the level of equipment.  
Do not use them for any other purpose.

## Accessing the tool kit

The tool kit is stored in the boot, under the floor.

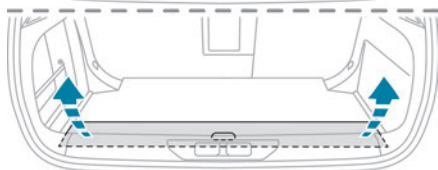
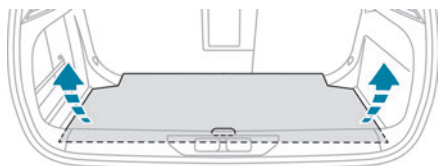

#### Hatchback

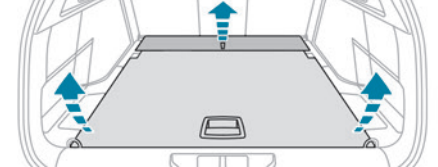
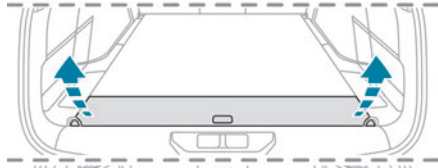
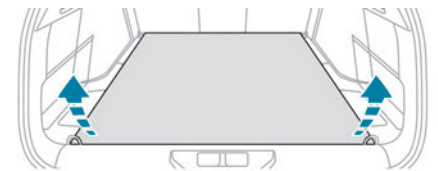

#### SW

##### Versions with rigid boot floor

- ▶ Open the boot.
- ▶ Lift the rigid boot floor.
- ▶ Attach the floor hook to the upper boot seal.

##### Versions with hinged boot carpet (Rechargeable hybrid or Electric)

- ▶ Open the boot.
- ▶ Unfold the hinged boot carpet by pulling its handle until it is fully opened.

##### Versions with 2-position boot floor (SW)

Tools can also be accessed from the row 2 seats, by tilting the backrest of the rear bench seat.

- ▶ Open the boot.
  - ▶ Lift the cover using the cord at the back of the boot.
- or
- ▶ Place the adjustable boot floor in the high position.
  - ▶ Lift the adjustable boot floor and engage it in the inclined position in the lateral stops to secure it in this position.

#### With temporary puncture repair kit

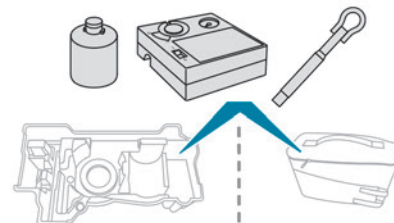

#### With spare wheel

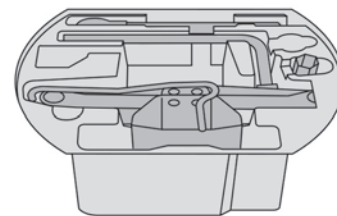

**!** The jack must only be used to change a wheel with a damaged or punctured tyre. Do not use any jack other than the one supplied with the vehicle. If the vehicle does not have its original jack, contact a PEUGEOT dealer or a qualified workshop to obtain the one that was intended by the manufacturer.

The jack meets European standards, as defined in the Machinery Directive 2006/42/CE, and also complies with UKCA requirement, as defined by the Supply of Machinery (Safety) Regulations 2008 No. 1597.  
The jack does not require any maintenance.

## List of tools

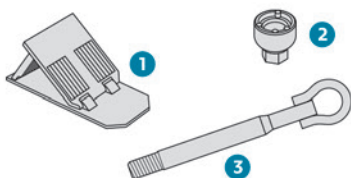

1. Chock to immobilise the vehicle (depending on equipment)
2. Socket for the security bolts (located in the glove box) (depending on equipment)  
To adapt the wheelbrace to the special 'security' bolts.
3. Removable towing eye

For more information on **Towing the vehicle** and using the removable towing eye, refer to the corresponding section.

## With temporary puncture repair kit

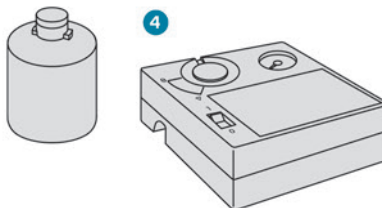

4. 12 V compressor with cartridge of sealant and speed limit sticker  
For temporary repair of a tyre and to adjust the tyre pressure.

For more information on the **Temporary puncture repair kit**, refer to the corresponding section.

## With spare wheel

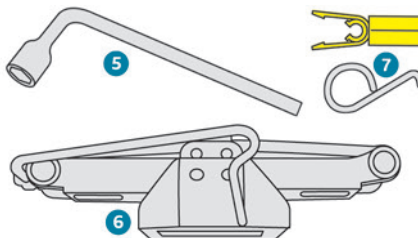

5. Wheelbrace  
For removing the wheel bolts.

6. Jack with integrated handle  
To raise the vehicle.
7. Wheel bolt cap removal tool (depending on equipment)  
For removing the wheel trim from steel wheels or the central bolt cover from alloy wheels.

For more information on the **Spare wheel**, refer to the corresponding section.

## Temporary puncture repair kit

**i** Visit this link to view explanatory videos:  
<http://q-r.to/bagG19>



Made up of a compressor and a sealant cartridge, it allows you to carry out a **temporary repair** of the tyre so that you can drive to the nearest garage.  
It is designed to repair most punctures located on the tyre tread.

**i** The vehicle's electric system allows the connection of the compressor to the 12 V power supply for long enough to repair a tyre after a puncture.

! Only the 12 V socket located **at the front** of the vehicle can be used to power the compressor.

i For more information on the **Tool kit**, refer to the corresponding section.

i Tyre inflation pressures are indicated on this label.

For more information on **Identification markings**, particularly this label, refer to the corresponding section.

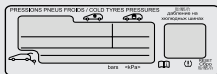

! Should the pressure of one or more tyres be adjusted, it is necessary to reinitialise the under-inflation detection system.

For more information on **Tyre under-inflation detection**, refer to the corresponding section.

## Repair procedure

! Do not remove any foreign body (e.g. nail, screw) which has penetrated the tyre.

- ▶ Park the vehicle without obstructing traffic and apply the parking brake.
- ▶ Follow the safety instructions (hazard warning lamps, warning triangle, high visibility

jacket, etc.) according to the legislation in force in the country in which you are driving.

- ▶ Switch the ignition off.

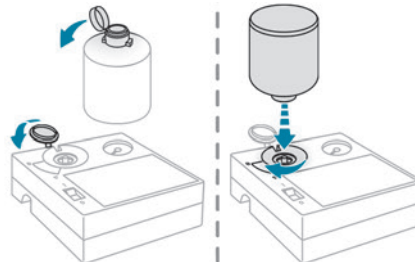

- ▶ Remove the transparent cap from the bottle of sealant.
- ▶ Lift the protective cover before installing the bottle of sealant on the compressor.
- ▶ Turn the bottle of sealant over and screw it a quarter turn into the compressor.
- ▶ Remove the valve cap from the tyre to be repaired, and place it in a clean place.

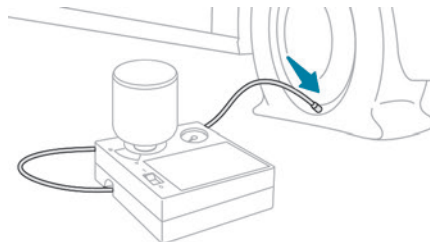

- ▶ Uncoil the pipe stowed under the compressor.

- ▶ Connect the pipe from the compressor to the valve of the tyre to be repaired and tighten firmly.
- ▶ Check that the compressor switch is in position "O".
- ▶ Fully uncoil the electric cable stowed under the compressor.
- ▶ Connect the compressor's electric plug to the vehicle's 12 V socket.



- ▶ Affix the speed limit sticker.

! The speed limit sticker must be affixed inside the vehicle in the area close to the driver, to remind them that a wheel is in temporary use.

- ▶ Switch the ignition on.

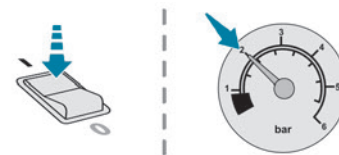

- ▶ Switch on the compressor by moving the switch to position "I" until the tyre pressure reaches 2 bar. The sealant product is injected under pressure into the tyre; do not disconnect the pipe from the valve during this operation (risk of blowback).

## Checking/adjusting tyre pressures

The compressor can be used, **without injecting sealant**, to check and, if necessary, adjust the tyre pressures.

- ▶ Remove the valve cap from the tyre and keep it in a clean place.
- ▶ Uncoil the pipe stowed under the compressor.
- ▶ Screw the pipe onto the valve and tighten firmly.
- ▶ Check that the compressor switch is in position "O".
- ▶ Fully uncoil the electric cable stowed under the compressor.
- ▶ Connect the compressor's electric plug to the vehicle's 12 V socket.
- ▶ Switch the ignition on.
- ▶ Start the compressor by placing the switch at position "I" and adjust the pressure to the value shown on the vehicle's tyre pressure label. To deflate: press the black button located on the compressor pipe, near the valve connection.

! If after 7 minutes the pressure of 2 bar is not reached, the tyre is damaged; contact a PEUGEOT dealer or a qualified workshop for assistance.

- ▶ Once the correct pressure is reached, put the switch in position "O".
- ▶ Remove the kit and stow it.
- ▶ Refit the cap on the valve.

! If after approximately 7 minutes, the pressure of 2 bar is not reached, this indicates that the tyre is not repairable; contact a PEUGEOT dealer or a qualified workshop for assistance.

- ▶ Move the switch to position "O".
- ▶ Disconnect the compressor's electric plug from the vehicle's 12 V socket.
- ▶ Remove the kit.
- ▶ Refit the cap on the valve.
- ▶ Remove and store the bottle of sealant.

! The sealant product is harmful if swallowed and causes irritation to the eyes. Keep this product out of the reach of children. The use-by date of the fluid is marked on the bottle. After use, do not discard the bottle into the environment; take it to a PEUGEOT dealer or an authorised waste disposal site. Do not forget to obtain a new bottle of sealant, available from a PEUGEOT dealer or a qualified workshop.

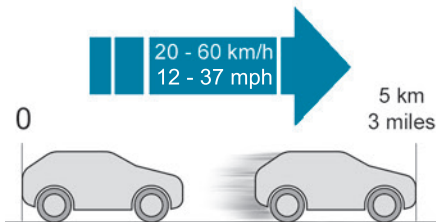

- ▶ Drive immediately for approximately 3 miles (5 kilometres) at reduced speed (between 12 and 37 mph (20 and 60 km/h)) to plug the puncture.

▶ Stop to check the repair **and the tyre pressure** using the kit:

- If the tyre pressure is incorrect, contact a PEUGEOT dealer to have the tyre changed.
- If the tyre pressure is correct, drive a second time for approximately 3 miles (5 kilometres) at reduced speed (between 12 and 37 mph (20 and 60 km/h)), stop then check again the tyre pressure using the kit to confirm the effective repair of the tyre.

! With a tyre repaired using this type of kit, do not exceed a speed of 50 mph (80 km/h) and do not drive more than 125 miles (200 km). You must contact a PEUGEOT dealer or a qualified workshop to have the repair checked and the tyre changed.

## Spare wheel

**i** Visit this link to view explanatory videos:  
<http://q-r.to/bagG19>



**i** For more information on the **Tool kit**, refer to the corresponding section.

### Accessing the spare wheel

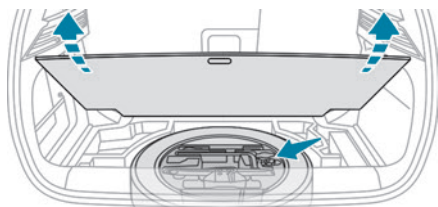

Hatchback

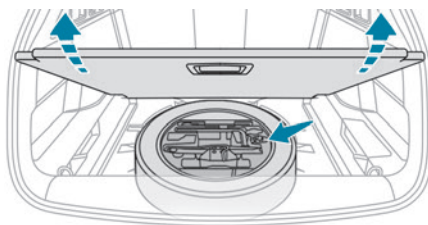

**SW**

The spare wheel is stored in the boot, under the floor.

To access the spare wheel, first refer to the **Tool kit** section.

**i** Depending on version, the spare wheel may be a standard (steel or aluminium) or 'space-saver' wheel.

### Removing the spare wheel

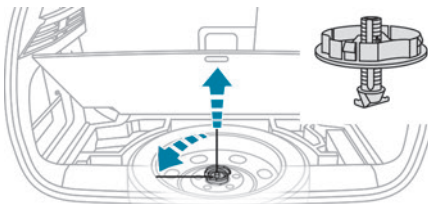

- ▶ Slacken the central nut.
- ▶ Remove the fastening device (nut and bolt).
- ▶ Lift the spare wheel towards you from the rear.
- ▶ Take the wheel out of the boot.

### Putting the spare wheel back in place

**!** The punctured wheel cannot be put under the boot floor.

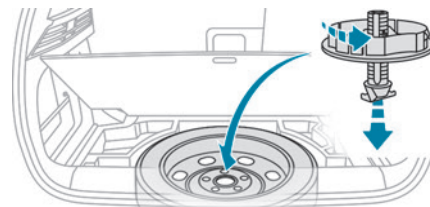

- ▶ Put the spare wheel back in place in its housing.
- ▶ Slacken the nut on the bolt by a few turns.
- ▶ Position the fastening device (nut and bolt) in the middle of the wheel.

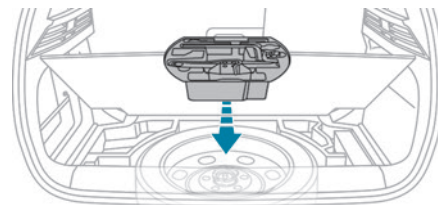

Hatchback

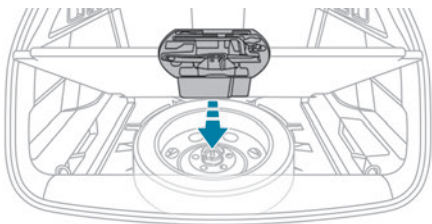
**SW**

- ▶ Tighten the central nut sufficiently to retain the wheel correctly.
- ▶ Put the tool box back in place in the middle of the wheel and clip it in place.

**Removing a wheel****! Parking the vehicle**

Immobilise the vehicle where it does not obstruct traffic: the ground must be level, stable and non-slippery.

With a manual gearbox, engage first gear to lock the wheels, apply the parking brake, unless it is set to automatic mode, and switch off the ignition.

With an automatic gearbox, select mode **P** to lock the wheels, apply the parking brake, unless it is set to automatic mode, and switch off the ignition.

Check that the parking brake indicator lamps on the instrument panel are on fixed.

The occupants must get out of the vehicle and wait where they are safe.

If necessary, place a chock under the wheel diagonally opposite the wheel to be changed. Never go underneath a vehicle raised using a jack; use an axle stand.

**i Wheel with wheel trim**

**When removing the wheel**, first remove the wheel trim by pulling with both hands on one of the upper arms.

**When refitting the wheel**, refit the wheel trim, starting by placing its aperture in line with the valve and then pushing it into place all round its edge with the palm of your hand.

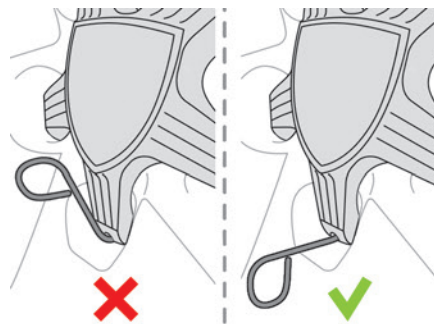
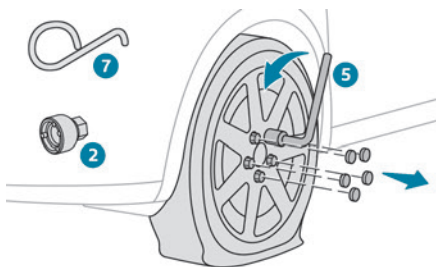

- If the vehicle has steel wheels, remove the wheel trim.
- If the vehicle has alloy wheels, remove the central bolt cover using tool 7.
- If the vehicle is so equipped, fit security bolt socket 2 to wheelbrace 5 to slacken the security bolt.
- Slacken the other bolts using the wheelbrace 5 only.

**!** Never use an impact wrench on the security bolt socket.

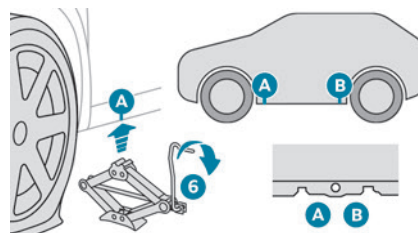

- ▶ Place the foot of jack **6** on the ground and ensure that it is directly below the front **A** or rear **B** jacking point on the underbody, whichever is closest to the wheel to be changed.

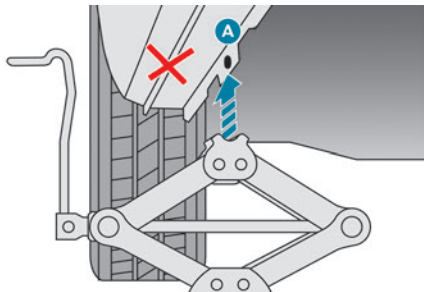

- ▶ Extend jack **6** until its head comes into contact with jacking point **A** or **B**; contact area **A** or **B** on the vehicle must be properly inserted into the central part of the head of the jack.
- ▶ Raise the vehicle until there is sufficient space between the wheel and the ground to easily admit the spare (not punctured) wheel.



Ensure that the jack is stable. If the ground is slippery or loose, the jack may slip or collapse - risk of injury!

Take care to position the jack strictly at one of the jacking points **A** or **B** under the vehicle, ensuring that the head of the jack is centred under the contact area on the vehicle. Otherwise, there is a risk of damage to the vehicle and/or of the jack collapsing - risk of injury!

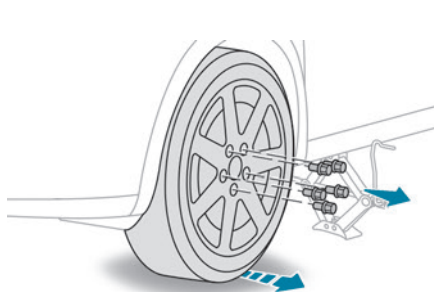

- ▶ Remove the bolts and store them in a clean place.
- ▶ Remove the wheel.

## Fitting a wheel

### **i** Fitting a steel or "space-saver" type spare wheel

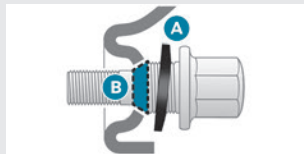

If the vehicle is fitted with alloy wheels, the washers **A** do not make contact with the steel or "space-saver" type spare wheel. The wheel is held in place by the conical contact surface **B** of each bolt.

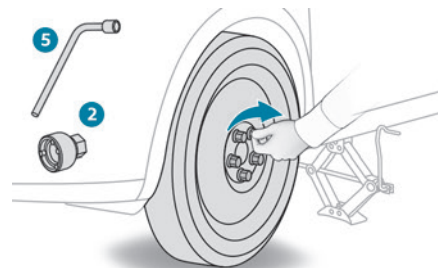

- ▶ Fit the wheel on the hub.
- ▶ Screw in the bolts by hand as far as possible.
- ▶ Pre-tighten the security bolt using the wheelbrace **5** equipped with a security socket **2**.
- ▶ Pre-tighten the other bolts using the wheelbrace **5** only.

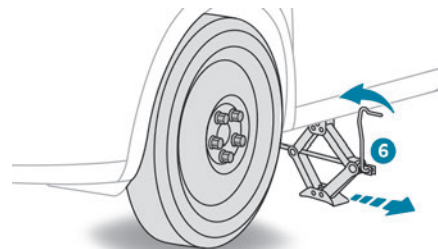

- ▶ Lower the vehicle again fully.
- ▶ Fold jack **6** and remove it.



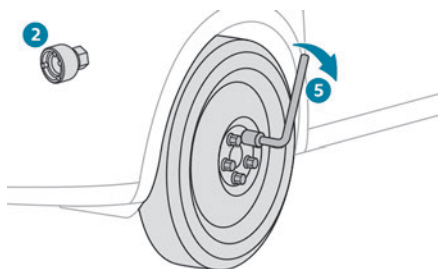

- ▶ Tighten the security bolt using the wheelbrace **5** equipped with a security socket **2**.
- ▶ Tighten the other bolts using the wheelbrace **5** only.
- ▶ Refit the bolt covers to each of the bolts (depending on equipment).
- ▶ Store the tools.

### After changing a wheel

The punctured wheel cannot be stored in place of the spare wheel. Place it in the boot.

**!** With a non-standard or 'space-saver' spare wheel



Deactivate certain driving aid functions (Active Safety Brake, Adaptive cruise control, etc.).

Do not exceed the maximum authorised speed of 50 mph (80 km/h) or the maximum distance of 50 miles (80 km). Driving with more than one spare wheel of this type is prohibited. The wheel trim from the replaced wheel must not be refitted.

**!** Go to a PEUGEOT dealer or a qualified workshop.

Have the tightening of the spare wheel's bolts and its tyre pressure checked. Have the punctured tyre examined. After inspection, the technician will advise you on whether the tyre can be repaired or if it must be replaced.

### Changing a bulb

**i** In some weather conditions (e.g. low temperature or humidity), misting on the internal surface of the glass of the headlamps and rear lamps is normal, and will disappear after the lamps have been on for a few minutes.

**!** The headlamps have polycarbonate lenses with a protective coating:

- **Do not clean them with a dry or abrasive cloth, nor with detergent or solvent products.**

- Use a sponge and soapy water or a pH neutral product.
- When using a high-pressure washer on persistent marks, do not keep the lance directed towards the headlamps, lamps or their edges for too long, so as not to damage their protective coating and seals.

### Light-emitting diode (LED) headlamps and lamps

Depending on version, the affected types of headlamps/lamps are:

- LED technology headlamps.
- Peugeot Matrix LED Technology 2.0 headlamps.
- Offset daytime running lamps/sidelamps/direction indicators.
- Direction indicator side repeaters.
- Side spotlamps.
- Full LED technology rear lamps.
- LED technology rear lamps.
- Brake lamps.
- Third brake lamp.
- Number plate lamps.

**!** Replacement of this type of bulb

Contact a PEUGEOT dealer or a qualified workshop. Do not touch LED or Full LED technology headlamps - risk of electrocution!

**!** Never look too closely at the light beam of LED technology lamps - risk of serious eye injury!



## Front lamps

### Model with LED technology headlamps

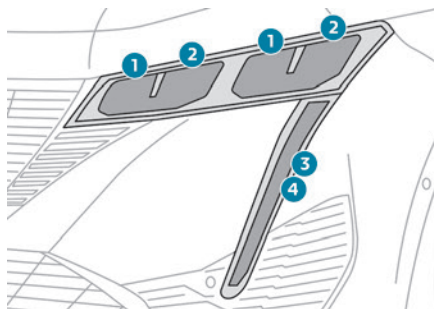
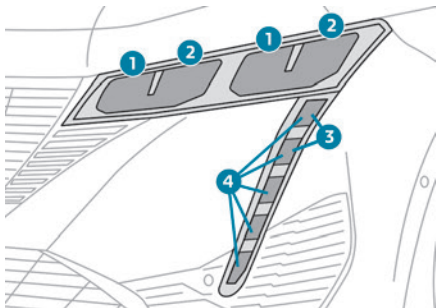

1. Main beam headlamps
2. Dipped beam headlamps
3. Direction indicators
4. Daytime running lamps/Sidelamps

### Model with Peugeot Matrix LED Technology 2.0 headlamps

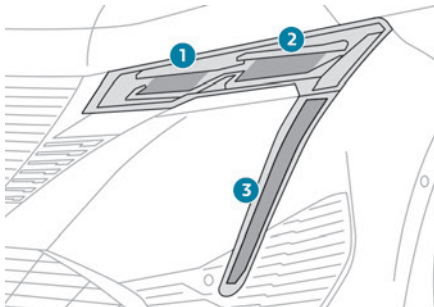

1. Dipped beam/main beam headlamps with Matrix Beam function

2. Dipped beam/main beam headlamps
3. Daytime running lamps/Sidelamps/Direction indicators

## Rear lamps

### Model with LED lamps

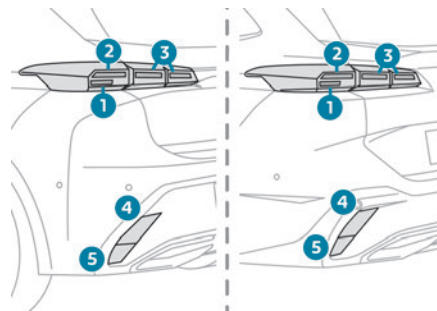

## Model with Full LED 3D lamps

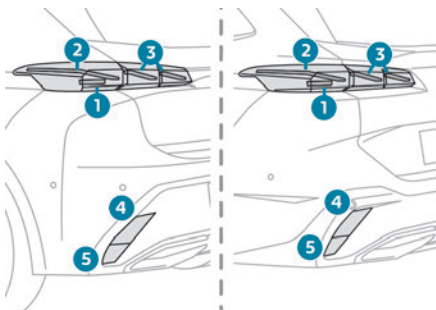

1. Direction indicators (LED)
2. Brake lamps/sidelamps (LED)
3. Sidelamps (LED)
4. Foglamps (P21W)
5. Reversing lamps (W16W)

## Reversing lamps/Foglamps

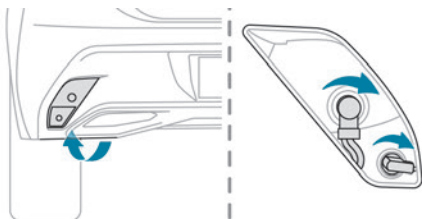

These bulbs are replaced from outside the rear bumper.

- ▶ Remove the fixing screw(s) from the access flap located under the bumper using a Torx screwdriver.
- ▶ Unclip the access flap.
- ▶ Turn the bulb holder a quarter turn and remove it.
- ▶ For the foglamp: turn the bulb a quarter turn and replace it.
- ▶ For the reversing lamp: pull out the bulb and replace it.

**!** When changing the bulb within a few minutes of switching off the ignition, take care not to touch the exhaust - risk of burns!

## Fuses

### **!** Changing a fuse

All work must be carried out only by a PEUGEOT dealer or a qualified workshop. The replacement of a fuse by a third party could cause a serious malfunction of the vehicle.

### **i** Installing electrical accessories

The vehicle's electrical system is designed to operate with standard or optional equipment. Before fitting other electrical equipment or accessories to your vehicle, contact a PEUGEOT dealer or a qualified workshop.

**!** PEUGEOT accepts no responsibility for the cost incurred in repairing the vehicle or for rectifying malfunctions resulting from the installation of accessories not supplied or not recommended by PEUGEOT and not installed in accordance with its recommendations, in particular when the combined power consumption of all of the additional equipment connected exceeds 10 milliamperes.

## 12 V battery/Accessory batteries

### Lead-acid starter batteries



These batteries contain harmful substances (sulphuric acid and lead). They must be disposed of in accordance with regulations and must never under any circumstances be discarded with household waste. Dispose of used batteries at a designated collection point.

**!** Protect your eyes and face before handling the battery.

All operations on the battery must be carried out in a well ventilated area and away from naked flames and sources of sparks, to avoid any risk of explosion or fire.

Wash your hands afterwards.

### ! Electronic control units/LED technology headlamps

Never connect the negative jump lead to the metal part of the electronic control units or at the back of the headlamps.

Risk of destroying the electronic control units and/or headlamps!

Connect to the remote earth point provided for this purpose.

### ! Frozen battery

Never try to charge a frozen battery - risk of explosion!

If the battery has frozen, have it checked by a PEUGEOT dealer or by a qualified workshop, who will verify that the internal components have not been damaged and that the case has not cracked, which could lead to a risk of leakage of toxic and corrosive acid.

### ! Automatic gearbox

Never try to start the engine by pushing the vehicle.

## Electric vehicles

### i Flat accessory battery

It is no longer possible to start the motor or recharge the traction battery.

### ! Precautions before working on the accessory battery

Select mode **P**, switch off the ignition, check that the instrument panel is off and that the vehicle is not being charged.

### ! Jump-starting another vehicle

Do not use the accessory battery to jump-start another vehicle or to charge another vehicle's battery.

## Symbols



No sparks or naked flames, no smoking.



Always protect your eyes. Explosive gases can cause blindness and injury.



Keep the vehicle's battery out of the reach of children.



The vehicle's battery contains sulphuric acid which can make you go blind or cause severe burns.



For more information, refer to the handbook.



Explosive gases can be present close to the battery.

## For petrol/Diesel versions

Procedure for starting the engine using another battery or for charging a discharged battery.

### Accessing the battery

The battery is located under the bonnet.

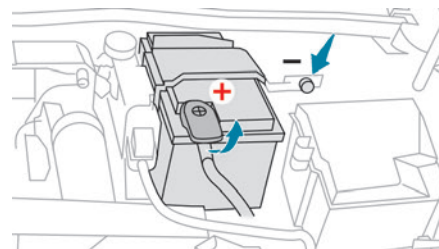

For access to the (+) terminal:

► Release the bonnet by pulling the internal release lever, then the external safety catch.

► Raise the bonnet.

(+) Positive terminal with a quick-release terminal.

(-) Negative terminal.

As the battery's negative terminal is not accessible, a remote earth point is located near the battery.

### Starting using another battery

If the vehicle's battery is flat, the engine can be started using a backup battery (either external or from another vehicle) and jump leads or using a battery booster.

! Never start the engine by connecting a battery charger.

Never use a 24 V or higher battery booster. Check beforehand that the backup battery has a nominal voltage of 12 V and a capacity

at least equal to that of the discharged battery.

The two vehicles must not be in contact with each other.

Switch off all electricity-consuming equipment on both vehicles (audio system, wipers, lighting, etc.).

Make sure that the jump leads are well away from the engine's moving parts (fan, belt, etc.).

Do not disconnect the (+) terminal while the engine is running.

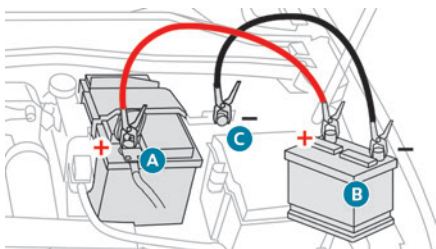

► Lift the plastic cover on the (+) terminal, if the vehicle has one.

► Connect the red cable to the (+) terminal of flat battery **A** (at the metal elbow), then to the (+) terminal of the backup battery **B** or of the booster.

► Connect one end of the green or black cable to the (-) terminal of the backup battery **B** or of the booster (or to an earth point on the assisting vehicle).

► Connect the other end of the green or black cable to the earth point **C**.

► Start the engine on the assisting vehicle and leave it running for a few minutes.

► Operate the starter on the broken down vehicle and let the engine run.

If the engine does not start immediately, switch off the ignition and wait a few moments before trying again.

► Wait for it to return to idle.

► Disconnect the jump leads **in reverse order**.

► Refit the plastic cover to the (+) terminal, if the vehicle has one.

► Allow the engine to run for at least 30 minutes, with the vehicle stationary, so that the battery reaches an adequate state of charge.

**!** Driving immediately without having reached a sufficient level of charge may affect some of the vehicle's functions (e.g. Stop & Start).

## Charging the battery using a battery charger

For optimum service life of the battery, it is essential to maintain an adequate state of charge.

In some circumstances, it may be necessary to charge the battery:

- When using the vehicle mainly for short journeys.
- If the vehicle is to be taken off the road for several weeks.

Consult a PEUGEOT dealer or a qualified workshop.

**!** To charge the vehicle's battery yourself, use only a charger compatible with lead-acid batteries with a nominal voltage of 12 V.

**!** Follow the instructions provided by the manufacturer of the charger. Never reverse polarities.

**i** It is not necessary to disconnect the battery.

- Switch the ignition off.
- Switch off all electrical consumers (audio system, lighting, wipers, etc.).

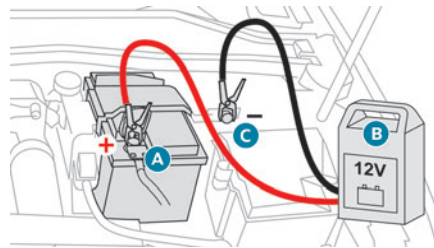

► Switch off charger **B** before connecting the cables to the battery, so as to avoid any dangerous sparks.

► Ensure that the charger cables are in good condition.

- ▶ Lift the plastic cover on the (+) terminal, if the vehicle has one.
- ▶ Connect the cables of charger **B** as follows:
  - the positive (+) red cable to the (+) terminal of battery **A**.
  - the negative (-) black cable to earth point **C** on the vehicle.
- ▶ At the end of the charging operation, switch off charger **B** before disconnecting the cables from battery **A**.

**!** If this label is present, use only a 12 V charger to avoid causing irreversible damage to the electrical components.

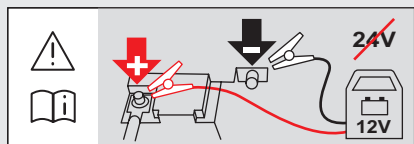

## Disconnecting/reconnecting the battery

In order to maintain an adequate state of charge for starting the engine, we recommend disconnecting the battery if the vehicle is to be unused for an extended period.

Before disconnecting the battery:

- ▶ Close all openings (doors, boot, windows, roof).
- ▶ Switch off all electricity-consuming devices (audio system, wipers, lamps, etc.).

- ▶ Switch off the ignition and wait for 4 minutes. After accessing the battery, it is only necessary to disconnect the (+) terminal.

### Quick-release terminal clamp

#### Disconnecting the (+) terminal

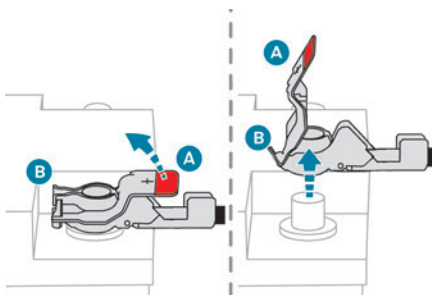

- ▶ Depending on equipment, lift the plastic cover on the (+) terminal.
- ▶ Raise lever **A** fully to release clamp **B**.
- ▶ Remove clamp **B** by lifting it off.

#### Reconnecting the (+) terminal

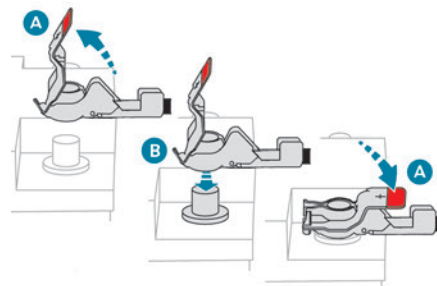

- ▶ Raise lever **A** fully.
- ▶ Refit open clamp **B** on the (+) terminal.
- ▶ Push clamp **B** fully down.
- ▶ Lower lever **A** to lock clamp **B**.
- ▶ Depending on equipment, lower the plastic cover on the (+) terminal.

**!** Do not force the lever when pressing on it, as if the clamp is not positioned correctly, locking will then not be possible. Start the procedure again.

**i** The Stop & Start system may not be operational during the trip following the first engine start. In this case, the system will only be available again after a continuous period with the vehicle immobilised, the duration of which depends on the exterior temperature and the

state of charge of the battery (up to about 8 hours).

## For hybrid versions

Procedure for starting the engine using another battery or for charging a discharged battery (12 V or 48 V).

▶ Access to the 12 V battery.

For more information on **Accessing the battery**, refer to the corresponding section.

▶ If necessary, perform the 12 V battery disconnection/reconnection procedure.

For more information on **Disconnecting/Reconnecting the battery**, refer to the corresponding section.

▶ After reconnecting the 12 V battery, perform the automatic reset procedures of the electronic systems and manual reset of some equipment.

For more information on **Following reconnection**, refer to the corresponding section.

## Starting using another battery

**i** The hybrid system starts the vehicle, but a 12 V supply is required. There are several reasons why the vehicle cannot be started.

If the 12 V battery is flat, the 12 V power supply can be ensured using a backup battery (either external or from another vehicle) and jump leads

or using a battery booster or using a battery charger.

**!** Never use a 24 V or higher battery booster.

Check beforehand that the backup battery has a nominal voltage of 12 V and a capacity at least equal to that of the discharged battery.

The two vehicles must not be in contact with each other.

Switch off all electricity-consuming equipment on both vehicles (audio system, wipers, lighting, etc.).

Make sure that the jump leads are well away from the engine's moving parts (fan, belt, etc.).

Do not disconnect the (+) terminal while the engine is running.

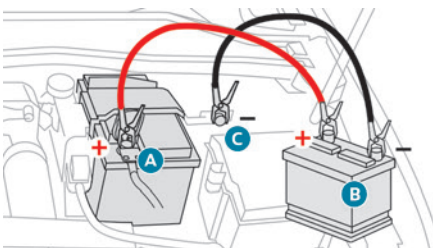

▶ Lift the plastic cover on the (+) terminal, if the vehicle has one.

▶ Connect the red cable to the (+) terminal of flat battery **A** (at the metal elbow), then to the

(+) terminal of the backup battery **B** or of the booster.

▶ Connect one end of the green or black cable to the (-) terminal of the backup battery **B** or of the booster (or to an earth point on the assisting vehicle).

▶ Connect the other end of the green or black cable to the earth point **C**.

▶ Start the engine on the assisting vehicle and leave it running for a few minutes.

▶ Operate the starter on the broken down vehicle and let the engine run.

If the engine does not start immediately, switch off the ignition and wait a few moments before trying again.

▶ Wait for it to return to idle.

▶ Disconnect the jump leads **in reverse order**.

▶ Refit the plastic cover to the (+) terminal, if the vehicle has one.

▶ Allow the engine to run for at least 30 minutes, with the vehicle stationary, so that the battery reaches an adequate state of charge.

**!** Driving immediately without having reached a sufficient level of charge may affect some of the vehicle's functions (e.g. e-Auto mode).

## Charging the 12 V battery using a battery charger

For optimum service life of the battery, it is essential to maintain an adequate state of charge.

In some circumstances, it may be necessary to charge the battery (e.g. if the vehicle is to be taken off the road for several weeks) Consult a PEUGEOT dealer or a qualified workshop.

**!** The hybrid system is connected to the 12 V network through the DC/DC converter. Any operation may affect the overall behaviour of the system. To charge the vehicle's battery yourself, use only a charger compatible with lead-acid batteries with a nominal voltage of 12 V.

**!** Follow the instructions provided by the manufacturer of the charger. Never reverse polarities.

**i** It is not necessary to disconnect the battery.

- ▶ Switch the ignition off.
- ▶ Switch off all electrical consumers (audio system, lighting, wipers, etc.).

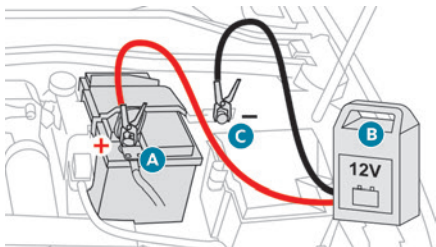

- ▶ Switch off charger **B** before connecting the cables to the battery, so as to avoid any dangerous sparks.
- ▶ Ensure that the charger cables are in good condition.
- ▶ Lift the plastic cover on the (+) terminal, if the vehicle has one.
- ▶ Connect the cables of charger **B** as follows:
  - the positive (+) red cable to the (+) terminal of battery **A**.
  - the negative (-) black cable to earth point **C** on the vehicle.
- ▶ At the end of the charging operation, switch off charger **B** before disconnecting the cables from battery **A**.

### Charging the 48 V battery using a 12 V battery charger

If the start fails, refer to the paragraph "**Starting using another battery**" and follow the recommended procedure.

In case of failure, especially after long storage, the 48 V battery may be discharged and require a charging process.

**!** Do not try to charge the hybrid system directly.

The hybrid system is connected to the 12 V network through the DC/DC converter. Any operation may affect the overall behaviour of the system.

**!** Only use a specific 12 V battery charger capable of maintaining 13.5 V with a high level of current 40-50 A (approx. 600 W). To charge the vehicle's battery yourself, use only a charger compatible with lead-acid batteries with a nominal voltage of 12 V. Never use a 24 V or higher battery booster.

**!** Follow the instructions provided by the manufacturer of the charger. Never reverse polarities.

**i** It is not necessary to disconnect the battery.

- ▶ Switch the ignition off.
- ▶ Switch off all electrical consumers (audio system, lighting, wipers, etc.).

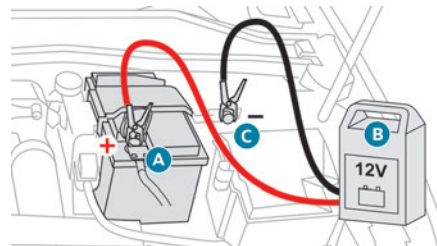

- ▶ Switch off charger **B** before connecting the cables to the 12 V battery, so as to avoid any dangerous sparks.
- ▶ Ensure that the charger cables are in good condition.



- ▶ Lift the plastic cover on the (+) terminal, if the vehicle has one.
- ▶ Connect the cables of charger **B** as follows:
  - the positive (+) red cable to the (+) terminal of battery **A**,
  - the negative (-) black cable to earth point **C** on the vehicle.
- ▶ Open the driver's door to wake up the vehicle (or turn the ignition on **without pressing the brake pedal**).

The hybrid system will automatically start charging the 48 V battery after 1 minute with a 12 V power supply higher than 13.5 V. The current supplied by the battery charger should be about 30-50A.

When the appropriate energy level is reached in the 48 V battery, the hybrid system automatically stops the charging process of the 48 V battery. The current supplied by the 48 V battery should be about 10-15 A.

- ▶ At the end of the charging operation, switch off charger **B** before disconnecting the cables from 12 V battery **A**.
- ▶ Refit the plastic cover to the (+) terminal, if the vehicle has one.
- ▶ Operate the starter on the vehicle and let the engine run.
- ▶ Wait for it to return to idle.
- ▶ Allow the engine to run for at least 30 minutes, with the vehicle stationary, so that the 48 V battery reaches an adequate state of charge.

## For rechargeable hybrid versions

The rechargeable hybrid system has two accessory batteries: one at the front and one at the centre of the vehicle.

### ! Replacing the accessory batteries

Contact a PEUGEOT dealer or a qualified workshop.

### ! Jump-starting another vehicle

Do not start or jump-start another vehicle using the vehicle's accessory batteries.

## Accessing the accessory batteries

### Front

The front battery is located under the bonnet.

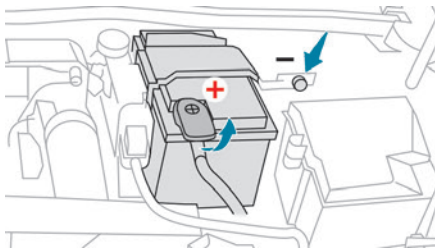

For access to the (+) terminal:

- ▶ Release the bonnet by pulling the internal release lever, then the external safety catch.
- ▶ Raise the bonnet.

(+) Positive terminal with a quick-release terminal.

(-) Negative terminal.

As the battery's negative terminal is not accessible, a remote earth point is located near the battery.

### Central

The central battery is located in the front armrest storage compartment.

To reach the battery:

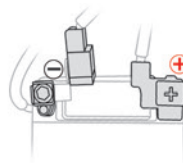

- ▶ Open the front armrest.
- ▶ Unclip the compartment's floor.
- (+) Positive terminal, protected by a red plastic cover (not accessible).
- (-) Negative terminal with a black quick-release connector.

## Charging the front battery using a battery charger

For optimum service life of the front battery, it is essential to maintain an adequate state of charge.

In some circumstances, it may be necessary to charge the front battery:

- When using the vehicle mainly for short journeys.
- If the vehicle is to be taken off the road for several weeks.

Consult a PEUGEOT dealer or a qualified workshop.

**!** To charge the vehicle's front battery yourself, use only a charger compatible with lead-acid batteries with a nominal voltage of 12 V.

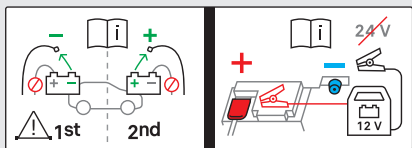

**!** Follow the instructions provided by the manufacturer of the charger.  
Never reverse polarities.

**i** It is not necessary to disconnect the battery.

- ▶ Switch the ignition off.
- ▶ Switch off all electrical consumers (audio system, lighting, wipers, etc.).

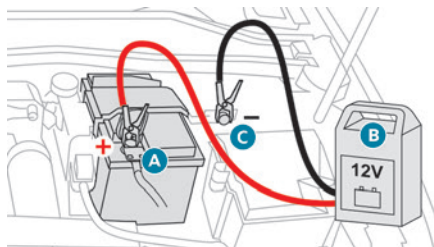

- ▶ Switch off charger **B** before connecting the cables to the battery, so as to avoid any dangerous sparks.
- ▶ Ensure that the charger cables are in good condition.
- ▶ Lift the plastic cover on the (+) terminal, if the vehicle has one.
- ▶ Connect the cables of charger **B** as follows:
  - Positive (+) red cable to the (+) terminal on battery **A**.
  - Negative (-) black cable to earth point **C** on the vehicle.
- ▶ At the end of the charging operation, switch off charger **B** before disconnecting the cables from battery **A**.

### Disconnecting/reconnecting the accessory batteries

Procedure for disconnecting/reconnecting the accessory batteries in the event of long-term immobilisation of the vehicle.

Before disconnecting the accessory batteries:

- ▶ Open the driver's door.
- ▶ Close all other doors.

- ▶ Switch off all electrical consumers (audio system, wipers, lamps, etc.).
- ▶ Switch off the ignition and wait for the **READY** indicator lamp to go out.
- ▶ Observe a waiting time of 4 minutes.

**!** Never reverse the order of the steps for disconnecting and reconnecting the accessory batteries - risk of irreversible damage!

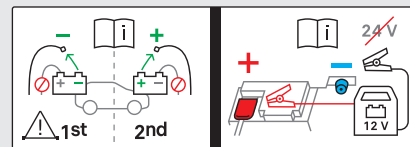

### Disconnection

#### Central battery:

- ▶ Disconnect the (-) terminal using the black quick-release connector.

#### Front battery:

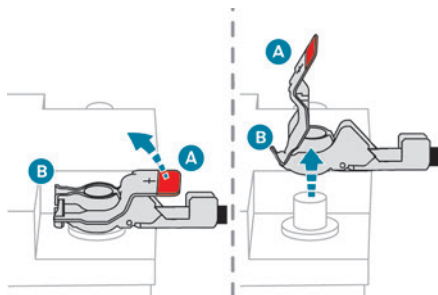

► Disconnect the (+) terminal by disconnecting the red quick-release clamp:

- Raise lever **A** fully to release clamp **B**.
- Remove clamp **B** by lifting it off.

### Reconnection

#### Front battery:

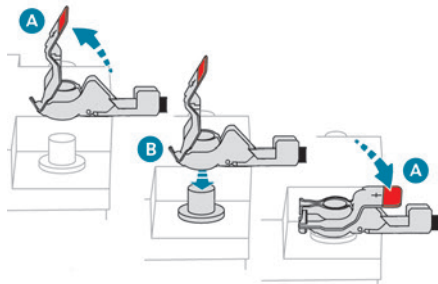

► Connect the (+) terminal by connecting the red quick-release clamp:

- Raise lever **A** fully.
- Refit open clamp **B** on the (+) terminal.

- Push clamp **B** fully down.
- Lower lever **A** to lock clamp **B**.

#### Central battery:

► Connect the (-) terminal using the black quick-release connector.

### Following reconnection

After reconnecting the battery, turn on the ignition and wait 1 minute before starting the engine, to enable the electronic systems to initialise.

If minor problems nevertheless persist following this operation, contact a PEUGEOT dealer or a qualified workshop.

Referring to the relevant section, reinitialise certain equipment:

- Electronic key.
- Sunroof.
- Electric windows.
- Date and time.
- Preset radio stations.

! After reconnecting the battery, the message **"Collision risk detection system fault"** is displayed on the instrument panel when the ignition is switched on. This operation is perfectly normal. The message will disappear while driving.

## Towing the vehicle

### i General recommendations

Observe the legislation in force in the country where you are driving. Check that the towing vehicle is heavier than the towed vehicle.

The driver must remain at the wheel of the towed vehicle and must have a valid driving licence.

When towing a vehicle with all four wheels on the ground, always use an approved towbar; ropes and straps are prohibited.

The towing vehicle must move off gently.

When the vehicle is towed with its engine off, there is no longer braking and steering assistance.

### ! A professional recovery service must be called in the following cases:

- broken down on a motorway or main road;
- not possible to put the gearbox into neutral, unlock the steering, or release the parking brake;
- not possible to tow a vehicle with an automatic gearbox, with the engine running;
- towing with only two wheels on the ground;
- four-wheel drive vehicle;
- no approved towbar available.

**!** Before towing the vehicle, it is essential to put the vehicle in free-wheeling mode. For more information on **Free-wheeling**, refer to the corresponding section.

**!** **Special feature of towing for hybrid vehicles**

**With both rear wheels on the ground:** it is only authorized for short distances (about 9 miles (15 km)) and at reduced speed (maximum 15 mph (25 km/h)).

**With all four wheels on the ground:** the vehicle can be towed a maximum of 0.06 mile (100 metres) at a maximum speed of 6 mph (10 km/h) (automatic gearbox in mode **N** and **N** displayed in the instrument panel).

**!** **Rechargeable hybrid vehicles**

Before any intervention, with the ignition on, depress the brake pedal and select mode **N**, then switch off the hybrid system (**READY** indicator lamp off).

Always call on professionals for recovery of the vehicle on a flatbed lorry or trailer. Use the towing eye **only** to free the vehicle if it is stuck, or to secure it for recovery on a flatbed lorry or trailer.

**i** **Electric vehicles**

An electric vehicle cannot under any circumstances be used to tow another vehicle. However, it may be used, for example, to exit a rut.

Type of vehicle (engine/gearbox)	Towing constraints			
	Front wheels on the ground	Rear wheels on the ground	Flatbed	4 wheels on the ground with towbar
Internal combustion/Manual				
Internal combustion/Automatic				
Hybrid/Automatic				
Rechargeable hybrid 2WD				
Electric 2WD				

**2WD:** 2-wheel drive.

**i** In case of battery or electric parking brake failure, it is essential to call a professional using flatbed recovery vehicles (excluding manual gearbox).

## Accessing the tools

For more information on accessing the **Tool kit**, refer to the corresponding section.

## Towing your vehicle

To access the front screw thread:

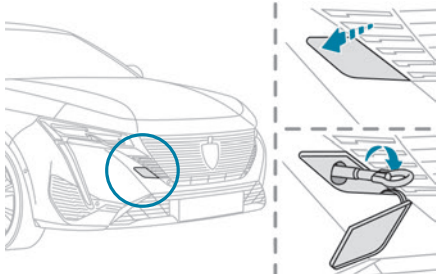

- ▶ Unclip the cover by pressing at its top left-hand corner.
- ▶ Release the cover downwards.

To be towed:

- ▶ Screw the towing eye in fully.
- ▶ Install the towbar.
- ▶ Put the gearbox into neutral.

**!** Failure to observe this instruction could result in damage to certain components (e.g. braking, transmission) and to the

absence of braking assistance the next time the engine is started.

### **!** Automatic gearbox

Never tow the vehicle with the driving wheels on the ground and the engine off.

- ▶ Unlock the steering and release the parking brake.
- ▶ Switch on the hazard warning lamps on both vehicles in accordance with the legislation in force in the country in which you are driving.
- ▶ Move off gently, drive slowly and only for a short distance.

## Towing another vehicle

To access the rear screw thread:

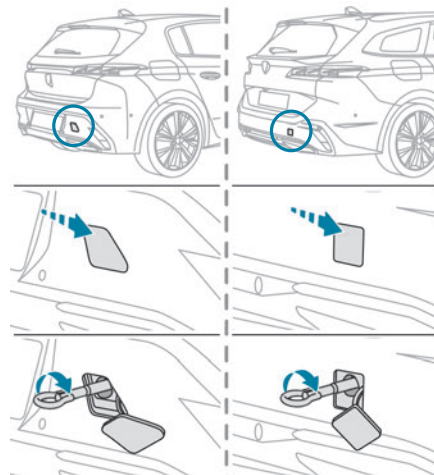

- ▶ Unclip the cover by pressing at its top left-hand corner.
  - ▶ Pull the cover downwards.
- To tow:
- ▶ Screw the towing eye in fully.
  - ▶ Install the towbar.
  - ▶ Switch on the hazard warning lamps on both vehicles.
  - ▶ Move off gently, drive slowly and only for a short distance.

## Engine technical data and towed loads

### Engines

The engine characteristics are given in the vehicle's registration document, as well as in sales brochures.

Only the values available at the time of publication are presented in the tables. Contact a PEUGEOT dealer or a qualified workshop to obtain missing values.

**i** The maximum power corresponds to the value type-approved on a test bed, under conditions defined by European legislation (Directive 1999/99/EC).

For more information, contact a PEUGEOT dealer or a qualified workshop.

### Weights and towed loads

The weights and towed loads relating to the vehicle are indicated on the registration document, as well as in sales brochures.

These values are also indicated on the manufacturer's plate or label.

For more information, contact a PEUGEOT dealer or a qualified workshop.

The GTW (Gross Train Weight) and towed load values indicated are valid up to a maximum altitude of 1,000 metres. The towed load value

must be reduced by 10% for each additional 1,000 metres of altitude.

The maximum authorised nose weight corresponds to the weight permitted on the towball.

**!** When exterior temperatures are high, the vehicle performance may be limited in order to protect the engine. When the exterior temperature is higher than 37°C, reduce the towed weight.

**!** Towing even with a lightly loaded vehicle can adversely affect its road holding. Braking distances are increased when towing a trailer. When using a vehicle to tow, never exceed a speed of 62 mph (100 km/h) (observe the local legislation in force).

## Engines and towed loads - Petrol

Engines	PureTech 130		PureTech 130 S&S		PureTech 130 S&S	
Gearboxes	EAT8 (Auto. 8-speed)		BVM6 (Manual 6-speed)		EAT8 (Auto. 8-speed)	
Codes	EB2ADTSM ATN8 Euro 6.3 EB2ADTSM ATN8 Euro 5		EB2ADTS MB6E STT Euro 6.3 / 6.4 EB2ADTSI MB6E STT Euro 6.3 / 6.4		EB2ADTS ATN8 STT Euro 6.3 / 6.4 EB2ADTSI ATN8 STT Euro 6.3 / 6.4	
Model codes: Hatchback: FP... SW: FR...	HNL/T HNL/N		HNS/L		HNS/T	
Body styles	Hatchback	SW	Hatchback	SW	Hatchback	SW
Cubic capacity (cc)	1,199		1,199		1,199	
Max. power: EC standard (kW)	96		96		96	
Fuel	Unleaded		Unleaded		Unleaded	
Braked trailer (within the GTW limit) (kg) on a 10% or 12% gradient	600 - 1,200*	-	1,300	1,250	1,200** - 1,400***	1,200** - 1,400***
Unbraked trailer (kg)	600 - 680*	-	660	680	680	710
Maximum authorised nose weight (kg)	70	-	70	70	70	70

\* Australia only.

\*\* With towing device fitted as an accessory.

\*\*\* With factory-fitted towing device.

## Engines and towed loads - Diesel

<b>Engines</b>	<b>BlueHDi 130 S&amp;S</b>		<b>BlueHDi 130 S&amp;S</b>	
<b>Gearboxes</b>	<b>EAT8 (Auto. 8-speed)</b>		<b>EAT8 (Auto. 8-speed)</b>	
Codes	DV5RC ATN8 STT Euro 6.4		DV5RCM ATN8 STT Euro 6.1	
Model codes: Hatchback: FB... SW: FC...	YHZ/T		YHZ/P	
Body styles	Hatchback	SW	Hatchback	SW
Cubic capacity (cc)	1,499		1,499	
Max. power: EC standard (kW)	96		96	
Fuel	Diesel		Diesel	
Braked trailer (within the GTW limit) (kg) on a 10% or 12% gradient	1,550	1,500	600	600
Unbraked trailer (kg)	710	730	600	600
Maximum authorised nose weight (kg)	70	70	70	70



## Engines and towed loads - Hybrid

	<b>HYBRID 136 e-DCS6</b>	
Codes	EB2LTDH2 EDCT6 Euro 6.4	
Model codes Hatchback: FP... SW: FR...	HPY/C	HPY/C
Body styles	Hatchback	SW
Braked trailer (within the GTW limit) (kg) on a 10% or 12% gradient	1,150	-
Unbraked trailer (kg)	720	-
Maximum authorised nose weight (kg)	70	-
<b>Petrol engines</b>	PureTech 136	
<b>Gearboxes</b>	Electric dual-clutch automatic 6-speed	
Cubic capacity (cc)	1,199	
Max. power: EC standard (kW)	100	
Fuel	Unleaded	
<b>Electric motor</b>		
Technology	Synchronous with permanent magnets	
Max. power: EC standard (kW)	21	
<b>Traction battery</b>		
Technology	Lithium-Ion	
Voltage (Volts DC)	48	
Installed capacity (kWh)	0.9	

## Engines and towed loads - Rechargeable hybrid

	HYBRID 180 e-EAT8		HYBRID 225 e-EAT8	
Codes	EP6FADTXHPE EATN8 FWD Euro 6.4		EP6FADTXHPD EATN8 FWD Euro 6.4	
Model codes: Hatchback: F3... SW: F4...	DGX/T		DGY/T	
Body styles	Hatchback	SW	Hatchback	SW
Braked trailer (within the GTW limit) (kg) on a 10% or 12% gradient	1,500	1,450	1,500	1,450
Unbraked trailer (kg)	750	750	750	750
Maximum authorised nose weight (kg)	70	70	70	70
<b>Petrol engine</b>	PureTech 150		PureTech 180	
<b>Gearbox</b>	Electric automatic 8-speed		Electric automatic 8-speed	
Cubic capacity (cc)	1,598		1,598	
Max. power: EC standard (kW)	110		132	
Fuel	Unleaded		Unleaded	
<b>Electric motor</b>				
Technology	Synchronous with permanent magnets		Synchronous with permanent magnets	
Max. power: EC standard (kW)	81		81	
<b>Traction battery</b>				
Technology	Lithium-Ion		Lithium-Ion	
Voltage (Volts AC)	240-400		240-400	
Installed capacity (kWh)	12.4		12.4	
<b>Combined power (kW)</b>	<b>133</b>		<b>165</b>	

	HYBRID 180 e-DCS7		HYBRID 225 e-DCS7	
Codes	EP6LTCHPE EDCT7 FWD Euro 6.4		EP6LTCHPD EDCT7 FWD Euro 6.4	
Model codes: Hatchback: F3... SW: F4...	DGM/H		DGN/H	
Body styles	Hatchback	SW	Hatchback	SW
Braked trailer (within the GTW limit) (kg) on a 10% or 12% gradient	1,200	-	1,200	-
Unbraked trailer (kg)	750	-	750	-
Maximum authorised nose weight (kg)	70	70	70	70
<b>Petrol engine</b>	PureTech 150		PureTech 180	
<b>Gearbox</b>	Electric dual-clutch automatic 7-speed		Electric dual-clutch automatic 7-speed	
Cubic capacity (cc)	1,598		1,598	
Max. power: EC standard (kW)	110		132	
Fuel	Unleaded		Unleaded	
<b>Electric motor</b>				
Technology	Synchronous with permanent magnets		Synchronous with permanent magnets	
Max. power: EC standard (kW)	81		81	
<b>Traction battery</b>				
Technology	Lithium-Ion		Lithium-Ion	
Voltage (Volts AC)	240-400		240-400	
Installed capacity (kWh)	12.4		12.4	
<b>Combined power (kW)</b>	<b>133</b>		<b>165</b>	

## Engines and towed loads - Electric

	<b>EV 156 Standard Range</b>	
Codes	MEL ZLE 54 FWD	
Model codes: Hatchback: FM... SW: FN...	ZKW/Z	
Body styles	Hatchback	SW
Braked trailer (within the GTW limit) (kg) on a 10% or 12% gradient	0	0
Unbraked trailer (kg)	0	0
Maximum authorised nose weight (kg)	70	70
<b>Electric motor</b>		
Technology	Synchronous with permanent magnets	Synchronous with permanent magnets
Max. power : EC standard (kW)/(hp)	115/156	115/156
<b>Traction battery</b>		
Technology	Lithium-Ion	Lithium-Ion
Installed capacity (kWh)	51 (Battery M)	51 (Battery M)
<b>Domestic charging</b>	<b>Mode 2</b>	
Alternating current (AC) voltage Rating (A)	230 (single-phase) 8 or 16	
<b>Accelerated charging</b>	<b>Mode 3</b>	
Alternating current (AC) voltage Rating (A)	230 (single-phase or three-phase) 16 or 32	

	<b>EV 156 Standard Range</b>	
Codes	MEL ZLE 54 FWD	
Model codes: Hatchback: FM... SW: FN...	ZKW/Z	
Body styles	Hatchback	SW
<b>Superfast charging</b>	<b>Mode 4</b>	
Direct current (DC) voltage	400	

## Dimensions (mm)

These dimensions have been measured on an unladen vehicle.

### Hatchback

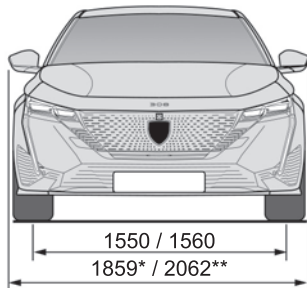

\* With folded mirrors.

\*\* With unfolded mirrors.

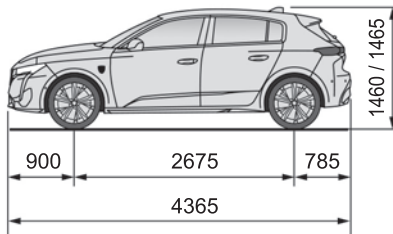
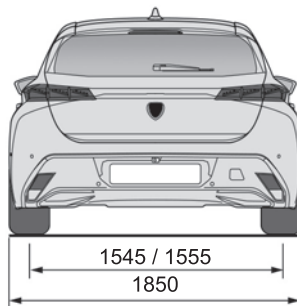

### SW

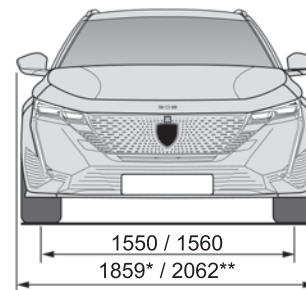

\* With folded mirrors.

\*\* With unfolded mirrors.

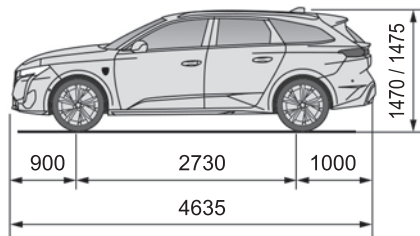
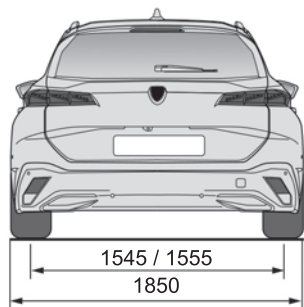

## Identification markings

Various visible markings for vehicle identification and vehicle search.

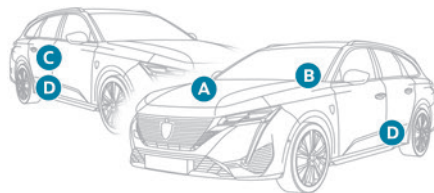
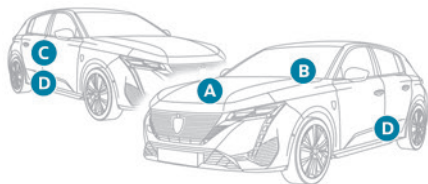

### A. Vehicle Identification Number (VIN), under the bonnet.

Stamped on the chassis.

### B. Vehicle Identification Number (VIN), on the dashboard.

Printed on an adhesive label visible through the windscreen.

### C. Manufacturer's label.

Affixed to the right-hand door.

Bears the following information:

- Manufacturer's name.
- European whole vehicle type approval number.
- Vehicle Identification number (VIN).
- Gross vehicle weight (GVW).
- Gross train weight (GTW).
- Maximum weight on the front axle.
- Maximum weight on the rear axle.

### D. Tyres/paint code label.

Affixed to the driver's door.

Bears the following information about the tyres:

- Tyre pressures, unladen and laden.
- Tyre specification, made up of the dimensions and type as well as the load and speed indices.
- Spare tyre inflation pressure.

Also indicates the paint colour code.

**i** The vehicle may be originally equipped with tyres with higher load and speed indices than those indicated on the label, without affecting tyre pressure (on cold tyres). In the event of a change in the type of tyres, contact a PEUGEOT dealer for the tyre fits approved for the vehicle.

# PEUGEOT i-Connect Advanced - PEUGEOT i-Connect

## GPS navigation - Applications - Multimedia audio system - Bluetooth® telephone

 The functions and settings described vary according to the version and configuration of the vehicle, and according to the country of sale.

 For safety reasons and because they require continued attention on the part of the driver, the following operations must be carried out with the **vehicle stationary** and the ignition on:

- Pairing the smartphone with the system via Bluetooth®.
- Using the smartphone.
- Connecting to Mirror Screen (Apple®CarPlay® or Android Auto).
- Changing the system settings and configuration.

 The message **Energy economy mode** is displayed when the system is about to go into standby.  
For more information on **Energy economy mode**, refer to the "Practical information" section.

 The AM radio selection mode is not available on electric vehicles.

 **Warning**  
Navigation is a driving aid. It cannot replace the driver. All guidance instructions should be carefully checked by the user. By using the navigation, you accept the following terms and conditions:  
[https://www.tomtom.com/en\\_gb/legal/eula-automotive/?388448](https://www.tomtom.com/en_gb/legal/eula-automotive/?388448)

## First steps

 The system starts when the ignition is switched on.

Short press, ignition off: system on/off.

Short press, ignition on: mute/restore sound.

Long press, ignition on: start standby mode (mute sound, screens and clock display off).

Rotation: volume adjustment.

## Information

This system gives access to the following elements:

- Audio equipment and telephone controls with display of associated information.
- Connected services and display of associated information.
- Navigation system controls and display of associated information (depending on equipment).
- Voice recognition (depending on equipment).
- Time and outside temperature.
- Heating/air conditioning system controls and reminders of settings.
- Settings for driving aid functions, comfort and safety functions, extended head-up display (depending on equipment and version), audio equipment and digital instrument panel.
- Settings for functions specific to rechargeable hybrid vehicles.
- Settings for functions specific to electric vehicles.
- Display of visual manoeuvring aid functions.
- Interactive handbook.
- Video tutorials (e.g. screen management, driving aids, voice recognition).

## Upper banner

Certain information is displayed permanently in the upper banner of the touch screen:

- Outside temperature from the vehicle's sensors (associated with a blue symbol if there is a risk of ice).
- Temperature setting reminder for the air conditioning on the driver's and passenger sides.
- Charge level of the connected smartphone.

- System connection status (Bluetooth®, Wi-Fi, mobile telephone network).
- Time.
- Quick access to the Mirror Screen® functions (associated with a connected smartphone).  
Swipe down from the upper edge of the touch screen to access the notifications centre and display a list of quick settings :Guest, Privacy Settings, Brightness, My Devices, night mode, etc.

## Principles



► Use this button (HOME) to display the most recent home page used; a second press displays the first home page, then press the virtual buttons displayed on the touch screen.



Scroll through the home pages by sliding your finger along the screen to the right or to the left.

### Principle of movement in the system

Depending on the pages displayed on the screen, scroll through the text or the menu (on the left side of the screen) by sliding your finger, as with a smartphone.

### Touch buttons



Display/hide the context menu.



Return to the previous page.

► To change the status of a function, press the description for the corresponding line (change

confirmed by the slider moving to the right/left: function activated/deactivated).



Access to additional information about the function.



Access to a function's settings.



Add/delete shortcuts.

## Configuring profiles



Press the "**Settings**" application.

In the list, select the "**Profile**" tab.

The screen displays a "Guest" profile built into the system and allows you to create and personalise several new profiles with or without an associated mobile device.



The "**Guest**" profile has a default display with the possibility of adding to it and/or returning it to its initial configuration. This profile is built into the system and cannot be deleted.



Each profile created can be associated with a mobile device of your choice connected via Bluetooth®; the Bluetooth® function of the mobile device must first be activated. This association allows the system to detect your presence in the vehicle when it starts and to propose the activation of your personalised profile.

If a profile is not connected to the mobile device, the last profile used will be highlighted.



Select "**Create Profile**", then follow the procedure.

Creating a new profile allows you to personalise:

- Language, units, Privacy Settings.
- Screen configuration, appearance, i-Toggles (depending on equipment).
- Audio settings, favourite radio stations.
- Lighting, interior ambience (refer to the "Ease of use and comfort" section).
- Navigation history, favourite points of interest (POIs), navigation settings.
- Some driving aids and the list of favourites.



To delete a profile, select it from the list of profiles then press the bin.

## Privacy Settings

The "Privacy Settings" management is associated with each profile. This function is used with:

a "Guest" profile configured by default in "Private Mode",

or

a profile to be created in the system, with or without connection to a mobile device.

For each profile (even "Guest"), the last privacy mode saved value will be restored.



### "Sharing Data and Location"

This mode allows the vehicle to externally transmit all the personal data needed for each valid available connected service.

**i** The personal data required to use the connected services is sent to the providers of these services.



**"Sharing Data"**

This mode allows the vehicle to externally transmit all the data needed for each valid available connected service, with the exception of vehicle location data (e.g. GPS coordinates).

**i** Some connected services may not function without the vehicle location data.

**i** This mode will not be applied to the emergency call function or to specific services to which the user has consented under the terms of commercial contracts (e.g. Connected alarm).

**"Private Mode"**

This mode does not allow the vehicle to transmit personal data outside the vehicle.

**i** Connected services will only perform local processing inside the vehicle with limited functions.

**i** This mode will not be applied to the emergency call function or to specific services to which the user has consented under the terms of commercial contracts (e.g. Connected alarm).

**Professional purposes**

If the vehicle is used for professional purposes or under the terms of specific contracts (e.g. corporate fleet, government assignment), some privacy modes will not

be available for the user on the screen, depending on the data sharing needs of the services.

To change mode, swipe down from the upper edge of the touch screen to display all of the quick settings.



Press this button and select the chosen mode. The mode is highlighted.

OR



Press the **"Settings"** application.

In the list, select the **"Connectivity"** tab.



Select **"Privacy Settings"**.



Choose the mode.

## Internet portal

During the first use, upon acquisition of the vehicle, the user is invited to select the country of residence for the use of the Internet portal. If the country is not selected, the notification is stored in the notification centre and disappears once the country is selected. Slide a finger on the touch screen from top to bottom to display all the notifications.

The selection of a country is necessary to use the available internet applications.



Press the **"Settings"** application.

In the list, select the **"Connected Services"**.



Choose the country.



The first time you use it, via a connected mobile device, the system links to your profile. The connected mobile device serves as an access key to saved personal information. First activate the mobile device's Bluetooth® function.

Select the desired application, authentication will be requested if necessary. This authentication will be saved for future uses via the mobile device connected to the current profile.

An authentication will be requested at each use if the mobile device is not connected to the current profile or if the Guest profile is used.



With the use of the "Guest" profile, an identification will be requested for each use.

## Updating the system

**Managing devices remotely and remote updating of software and firmware.**

Being an integral part of the service used to provide connected services contract(s), the required management of devices as well as the required updating of the software and firmware associated with the aforementioned connected service will be carried out remotely, in particular using "Over the Air" technology. To do this, a secure connection via radio network is established between the vehicle

and the Manufacturer's device management server each time the ignition is switched on, when a mobile telephone network is available. Depending on the vehicle's equipment, the connection configuration must be set to "Connected vehicle" to enable the connection to the radio network. Irrespective of a valid subscription to a connected service, the remote management of devices relating to or connected with the security of devices, and the updating of software and firmware, will be carried out when necessary in order to comply with a legal requirement applicable to the Manufacturer (e.g. the applicable law in terms of product liability, the regulations governing e-call) or when necessary to protect the respective vital interests of the vehicle's users and passengers. The establishment of a secure connection via radio network and the corresponding remote updates are not affected by the privacy settings and are intended to be carried out after being initialised by the user in response to a related notification.

The system can notify the receipt of an update when it is connected to an exterior Wi-Fi network or a mobile telephone network.

Large updates are downloaded only via the Wi-Fi network.

The availability of an update is notified on the screen at the end of the journey with an option

of immediate installation or postponement of installation.

The installation time is variable and can take several minutes with a maximum of about 30 minutes. A notification will give an estimate of the duration and a description of the update. Update information is available through the "Settings" application.



Press the "**Settings**" application.

In the list, select the "**Updates**" tab.



This button allows you to change the authorisation for automatic downloading of updates via an exterior Wi-Fi network.

**!** For safety reasons and because it requires sustained attention on the part of the driver, the installation must be carried out with the ignition on but without starting the engine.

The installation cannot be carried out in the following cases:

- engine running.
- emergency call in progress.
- insufficient battery level.
- when charging for electric vehicles.

If an update has failed or has expired, contact a dealer or a qualified workshop.

**!** The Manufacturer does not charge for the use of this service.

However, the use of Wi-Fi and/or mobile telephone networks by your smartphone may

incur extra charges if you exceed the data allowance included in your contract. Any associated costs will be billed to you by your mobile telephone operator.

## Personalisation



Press and hold the screen from one of the system's home pages.

Or



Press the "**Settings**" application.

In the list, select the "**Customization**" tab. Press the "**Displays**" field.

A page divided into 2 parts is displayed.

Press the HOME button at any time to leave this page.

## Personalising the screen



Press the pencil in the "**Customize Touchscreen**" part.

A representation of the organisation of the different home page (**HOME**) Widgets is displayed.



A Widget is a reduced window of an application or service.

## Adding a Widget



To add a Widget, press "**Widget**" on the left of the screen.

Or



Press one of these buttons on the screen.

Select the desired Widget.



Press the back arrow to return to the previous page.

## Organising the Widgets on a home page (HOME)

To move a Widget, press and hold it, then drag it to the desired location.

## Adding a page



To add a page, press "**Page**" on the left of the screen.



Press the back arrow to return to the previous page.

## Deleting a Widget



To move a Widget to the bin, press and hold it, then drag it to the bin.

## Personalising the instrument panel



Press the pencil in the "**Customize Driver Information**" part.

The modification of the organisation of the different Widget is displayed on the instrument panel in real time.

- A Widget is a reduced window of an application or service.

## Adding a Widget



To add a Widget, press "**Widget**" on the left of the screen.

Or



Press one of these buttons on the screen.

Select the desired Widget.



Press the back arrow to return to the previous page.

## Deleting a Widget



To move a Widget to the bin, press and hold it, then drag it to the bin.

## Personalising i-Toggles

(depending on equipment)

In the central screen, display the page containing the button that you want to include.

- The shortcuts are used to access an application (air conditioning page, radio page, etc.) or to perform an action (set the temperature to 21°, call a selected directory contact, etc.).



Press and hold the shortcut you want to replace.

A panel is displayed on the central screen with all of the eligible shortcuts in boxes.

A notification also informs you of the next step to perform.

Select the new shortcut required. It will be duplicated in i-Toggles and will replace the one

originally selected. A notification also informs you of this.



To exit this function at any time, press this button or press the main "Home" button.

## Steering-mounted controls



**Voice control:**

Short press, system voice commands (depending on equipment).

Long press, voice commands of the smartphone connected using Bluetooth® or Mirror Screen® (Apple®CarPlay®/Android Auto) via the system.



Increase volume.



Decrease volume.

Mute the sound: long press on the decrease volume button.

Restore the sound by pressing one of the two volume buttons.



**Incoming call** (short press): accept the call.

**Call in progress** (short press): hang up.

**Incoming call** (long press): refuse the incoming call.

**Out of call** (short press): access the call log of the telephone connected via Bluetooth®.

**Mirror Screen® connected** (short press): access the projected view of the telephone application of your Mirror Screen® equipment.



**Radio:** automatic search for the previous/next station (in the list of radio stations sorted by name or by frequencies).

**Media:** previous/next track, movement in the lists.

**Phone:** browse the telephone's call log.

**Short press:** validate a selection. Out of selection, display the lists.

## Applications



From the home page, press this button to access the applications wall.



From any page, press the touch screen with three or more fingers to display the applications wall.



### Help

Access the handbook and watch tutorials.



### Media

Select an audio source or radio station.



### Mirror Screen®

Smartphone connected with Mirror Screen®: access to the projected view of Apple®CarPlay® or Android Auto.

Smartphone not connected: access the menu allowing you to connect a smartphone.



### Navigation

(depending on equipment)

Enter navigation settings and choose a destination.

Use services available in real time, depending on equipment.



### Voice commands

(depending on equipment)

Use the system or smartphone voice recognition via the system.



### Phone

Telephone not connected: access the menu allowing you to connect a telephone.

Telephone connected: access the call log, contacts and telephone settings.

Two connected telephones: access the contents of the priority telephone with the possibility of changing the priority of the telephone.



### Settings

Main settings for the audio system, touch screen and digital instrument panel.

## Voice commands

### First steps

#### (depending on equipment)

The voice recognition service offers a choice of 20 languages minimum (French, German, English (UK), English (US), Arabic, Brazilian, Chinese, Danish, Spanish, Hebrew, Italian, Japanese, Dutch, Norwegian, Polish, Portuguese, Russian, Swedish, Czech, Turkish) available with the cellular network and in line with the language chosen and previously configured in the system.

The system supports two languages for cases where the area in which the vehicle is travelling is not covered by the cellular network.

These languages, referred to as on-board languages, are downloaded into the system.

If the chosen language has not been downloaded, a message on the screen appears as soon as the cellular network is not connected for the first time and offers to download it.

To use this new language in all areas, download it beforehand (ignition on without starting the engine) via the Wi-Fi network.

Apply the download procedure displayed on the screen.

Downloading this new language removes the least used on-board language.

## Information - Using the system



When voice commands are activated, say your command after the audible signal.

For commands in several stages, interaction takes place with the system to complete the initial request.

Some commands self-validate after 7 seconds. If the system has not taken your command into account, it will indicate this by a voice message and an on-screen display.



Press the "Settings" application.

In the list, select the "Voice Assistant" tab.



Activate/Deactivate:

- **"Detect (Wake up Word)"**: to invoke the voice recognition using the keyword **"OK Peugeot"**.
- **"Data Usage"**: to authorise our supplier to re-use your data in order to let him globally improve its capabilities in term of voice recognition and voice assistance.

### **i** Voice Assistant/Data usage

Vehicle's location and voice recordings are not concerned; only textual transcriptions of your conversations with the voice assistant are kept after to be pseudonymised.

## Opening voice recognition



Voice commands can be used on any screen page, provided there are no other sources which take priority in use (reverse, emergency or assistance call, telephone call, other smartphone voice recognition already launched).

Choice of opening voice recognition:

- ▶ Say **"OK Peugeot"**.

or

- ▶ Press the button located on the steering wheel.

or

- ▶ Press the touch screen button.



To ensure that voice commands are always recognised by the system, please follow these recommendations:

- **Use natural language in a normal tone without breaking up words or raising your voice.**

- After opening voice recognition with the steering wheel-mounted button or the button on the touch screen, always wait for the "beep" (audible signal) before talking. No "beep" sounds when voice recognition is opened using **"OK Peugeot"**.
- For optimal operation, it is recommended that you close the windows and the sunroof (depending on equipment) to avoid any external interference, and switch the ventilation off.
- Before speaking the voice commands, ask the other passengers not to speak.



Voice command example for air conditioning:

**"raise the fan speed"**  
**"Turn on air conditioning"**  
**"i'm too hot"**



Voice command example for radio and media:

**"I want to listen to michael jackson"**  
**"switch to radio"**  
**"tune to 88.5"**



Media voice commands are only available with an USB connection.



Voice command example for navigation:

**"navigate home"**  
**"Navigate me to gabrielle's house"**  
**"search for public parking nearby"**



Depending on the country, give destination (address) instructions in the language configured for the system.



Voice command example for telephone:

**"Call Matthew's mobile"**  
**"call 0113 345 9869"**  
**"Call jonathan"**



If there is no telephone connected by Bluetooth®, a pop-up window appears: **"Connect a telephone by Bluetooth®"**, and the voice session will be closed.



Voice command example for the weather:

**"do i need a raincoat"**  
**"how is the weather tonight"**  
**"what is today's humidity level"**

## Navigation







### Navigation home screen

(depending on equipment)



Access to additional videos















<https://www.tomtom.com/PSAGroup-Connected-Nav>

-  Press the **"Navigation"** application to display the navigation home screen.
-  Press **"Search"** to enter an address or a name.
-  Press this button to display the main menu for the various options.
-  Press this button to display the 3D/2D mode.
-  Select **"Sound activated"**, **"Alerts only"** and **"Silent"** with successive presses on this button.
-  Press the "plus"/"minus" buttons to zoom in/out, or use two fingers on the screen.

### Main menu

-  Press the **"Navigation"** application to display the navigation home screen.
-  Press this button to display the main menu for the various options.

-  Select **"Search"** to enter an address, name or some points of interest.
-  Select **"Go home"** using an address previously saved in **"Add home"**.
-  Select **"Go to work"** using an address previously saved in **"My places"**.
-  Select **"Recent destinations"** to display the latest destinations searched.
-  Select **"Current trip"** to open another menu and perform various actions for the current planned route.
-  Select **"My places"** for quick access to saved places as well as favourite destinations.
-  Select **"My trips"** to display your favourite routes.
-  Select **"Parking"** to display the various parking options in the area.
-  Select **"Service station"** to display the different service stations on the current route or near the current location.
-  Select **"TomTom service"** to check the network status.
-  Select **"Settings"** to enter the vehicle type and to personalise the display, voice instructions, map options, trip planning, sounds and alerts, and system information.
-  Select this button to display details on software versions as well as legal information. Details of the Open Source software libraries used and their licence URLs.

**i** Regular connection to a secure Wi-Fi access point automatically updates the installed mapping globally. The mapping is also updated using a cellular network, depending on version, country of sale, the vehicle's level of equipment, as well as the subscription to connected services and options. However, using your smartphone's Wi-Fi and/or cellular networks may incur additional charges if you exceed your data plan. These charges, if any, will be passed on to your telephone operator's bill.

## Connectivity

### Connecting a wired device by USB

The USB connection of a mobile device allows it to be recharged. It makes its authorised media content available to the system (Media content of iPod® type).

 Only one USB socket will allow a Mirror Screen connection (Apple®CarPlay® or Android Auto) for the compatible connected mobile devices and to use some of the device's applications on the touch screen. For more information on the USB socket compatible with the Mirror Screen® function, refer to the "Ease of use and comfort - Fittings" section.

The mobile device is in charging mode when connected with the USB cable.

**i** It is recommended that you use your device's original USB cables, preferably with a short cable to ensure optimum performance.

**!** To protect the system, do not use a USB hub.

## Bluetooth® connection

Connecting a mobile device to the vehicle's system via Bluetooth® provides access to its contents and its "Media" streaming. It also enables the Phone function to be activated.

The connection can be initiated either from the mobile device's Bluetooth® menu or from the vehicle's system, which requires opening the "My Devices" menu for the first connection.

**i** In some cases, you will need to unlock your device and check the authorisation to synchronise contacts and recent calls. Some features may not be supported by your device.

For information on the partial or full compatibility of device models or smartphones, please connect to the Brand's national website.

### Pairing procedure from a device



From the Bluetooth® menu on your mobile device, select the system's name from the list of detected devices.

**i** In order to make your system's Bluetooth® visible, first open the "**My Devices**" menu on the system.

Continue the first connection procedure proposed by the system and on the device. For example: validating pairing codes.

### Pairing procedure from the system



Press the "**Settings**" application.

In the list, select the "**Connectivity**" tab.



Select "**My Devices**".



Select the name of the mobile device that you want to connect, from:

– The list of known devices (if the device has already been connected to the system).

or

– The list of detected devices (if the device has never been connected to the system or previously deleted from the system).

**i** A mobile device already connected to the system will be able to reconnect automatically when the vehicle is started, once the user profile has been selected. Automatic reconnection is put on hold as soon as the "My Devices" menu is opened.

This is to allow the system to make its Bluetooth® visible for the connection of a new device.

The system is disconnected when the driver's door is opened and the ignition is switched off.

### Automatic reconnection

The system allows automatic reconnection of devices already connected and detected when a user profile is selected.

The priority reconnected devices are those which have been linked to the selected user profile or, failing this, the last connected devices.

## Wi-Fi connection

The system has an external Wi-Fi connection mode for performing system updates.



Press the "**Settings**" application.

In the list, select the "**Connectivity**" tab.



Select "**Wi-Fi**".



Activate/Deactivate "**Wi-Fi**".

The system starts a search for nearby Wi-Fi networks. This may take a few seconds.

Select the Wi-Fi network to connect to and enter its password.



To protect your system, only networks with a sufficient level of security are

allowed to connect. WPA2 encryption level, equivalent to a domestic level, is required.

**i** Any network already connected to the system will reconnect automatically as soon as it is detected by the system and after having previously activated the Wi-Fi function.

**i** The Wi-Fi connection of the system to a device already connected using a Mirror Screen® wireless connection is not possible. In this case, favour a Mirror Screen® connection using the USB socket.

## Device management

For each device already connected to the system using a wireless connection (Bluetooth® or wireless Mirror Screen® connection), it is possible to determine a preferred connection mode (depending on the functions the device can support). It is therefore possible to determine whether the device should be connected using a wireless Bluetooth® connection or a wireless Mirror Screen® connection each time the system is started once the profile is chosen.



Press the "**Settings**" application.

In the list, select the "**Connectivity**".



Select "**My Devices**" to display the list of paired devices.



Press this button to manage the connection of a device.

Choose a connection type then confirm this choice by pressing "**APPLY**".

## Deleting a device



Press the "**Settings**" application.

In the list, select the "**Connectivity**".



Select "**My Devices**" to display the list of paired devices.



Press this button.

Press "**DELETE**".

Confirm by pressing "**YES**".



Some devices that have just been deleted from the system request a connection, refuse this request.

## Mirror Screen®



When a smartphone is connected using Mirror Screen®, the vehicle's location and some vehicle data is sent to the smartphone (e.g. brand, left-hand or right-hand drive, day/night mode, physical speed).

## Apple® CarPlay® smartphone connection

Connecting just one Apple®CarPlay® smartphone can be carried out either by USB cable or using a wireless connection.



First activate the Siri® function on your Apple® smartphone.

If the device fails to connect, refer to the Apple website to check that the device is compatible with this function.

If the problem persists, delete all saved connections on the smartphone and on the system before attempting a new connection.

The cable connection requires that you deactivate the CarPlay function in the **Settings**, **Bluetooth** menu of your smartphone. In the **Bluetooth** menu, click on the "i" next to the relevant vehicle and deactivate CarPlay.



Connect the smartphone to the system using the USB socket compatible with Mirror Screen.

Apple®CarPlay® is automatically launched a few seconds after the USB connection has been established. In some cases, it may be necessary to unlock your device.

The smartphone charges when connected by the USB cable.

The cable connection allows you to avoid disconnections, especially when passing through toll booths.



Only one USB socket enables the Mirror Screen® connection (Apple®CarPlay®); refer to the "Ease of use and comfort - Fittings" section.

It is recommended that you use the device's original USB cables, preferably with a short cable to ensure optimum performance.



The wireless connection of an Apple®CarPlay® smartphone can be initiated from the **"My Devices"** menu.

First activate the smartphone's CarPlay® function.

In the **Bluetooth** menu, click on the **"i"** next to the relevant vehicle and activate CarPlay.



Press the **"Settings"** application.

In the list, select the **"Connectivity"**.



Select **"My Devices"** to display the device to be connected to Apple®CarPlay®.

If the device has already been connected to the system via Bluetooth®, select the device settings from the list of known devices and choose Apple®CarPlay® as the wireless connection mode.

If the device has never been connected to the system before, it will have to be paired (refer to the "Bluetooth® connection" section).

The system detects if the smartphone is compatible with Apple®CarPlay® and offers to connect to it following the pairing process.

Subsequent automatic connection of the smartphone requires activation of the Bluetooth® on your device.



As soon as the connection is established, press this button to display the **"Apple®CarPlay®"** interface.



To initiate the smartphone voice commands, press and hold the steering-mounted control button.

## Android Auto smartphone connection

Connecting just one Android Auto smartphone can be carried out either by USB cable or using a wireless connection.

**i** First install the **"Android Auto"** application via "Play Store" on your smartphone.

The **"Android Auto"** function requires a compatible smartphone.

If the device fails to connect, refer to the Android Auto website to check that the device is compatible with this function.

If the problem persists, delete all saved connections on the smartphone and on the system before attempting a new connection. To ensure an optimum wireless connection, we recommend avoiding placing your smartphone too close to other Wi-Fi networks to which it can connect automatically.

The cable connection requires that you deactivate the Android Auto wireless function, in the **Settings** menu of the **"Android Auto"** application of your smartphone.



Connect the smartphone to the system using the USB socket compatible with Mirror Screen®.

Android Auto is automatically launched a few seconds after the USB connection has been established. A validation procedure on the

smartphone has to be followed for the first connection, with the vehicle stationary.

The smartphone charges when connected by the USB cable.

The cable connection allows you to avoid disconnections, especially when passing through toll booths.

**i** Only one USB socket enables the Mirror Screen® connection (Android Auto); refer to the "Ease of use and comfort - Fittings" section.

It is recommended that you use the device's original USB cables, preferably with a short cable to ensure optimum performance.

The wireless connection of an Android Auto smartphone can be initiated from the **"My Devices"** menu.

First activate the smartphone's Android Auto® wireless function, in the **Settings** menu of the **"Android Auto"** application of your smartphone.



Press the **"Settings"** application.

In the list, select the **"Connectivity"** tab.



Select **"My Devices"** to display the device to be connected to Android Auto.

If the device has never been connected to the system before, it will have to be paired (refer to the "Bluetooth® connection" section).

The system detects if the smartphone is compatible with Android Auto and offers to connect to it following the pairing process.

If the device has already been connected to the system via Bluetooth®, select the device settings from the list of known devices and choose Android Auto as the wireless connection mode. The subsequent automatic connection of the smartphone requires activation of Bluetooth® on your device.



As soon as the connection is established, press this button to display the "Android Auto" interface.



To initiate the smartphone voice commands, press and hold the steering-mounted control button.

## Media

### Changing source



Press the "Media" application.



Press this button to change source (radio, audio streaming via a USB socket, Bluetooth® or Mirror Screen®).

### Selecting a radio station



Press the "Media" application.

In the list, select the "Player" tab.



Press one of the buttons to perform an automatic search for radio stations.

Or



Move the slider to manually search for frequencies up or down.

Or



Press this button.



Enter the frequency values using the virtual keypad.



Press this button to confirm.

A list of stations is available by pressing the "Stations" tab.



Press "Mute" to activate/deactivate the sound.



Radio reception may be affected by the use of electrical equipment not approved by the Brand, such as a charger with USB socket connected to the 12 V socket. The exterior environment (hills, buildings, tunnels, basement car parks, etc.) may block reception, including in RDS mode. This phenomenon is normal in the propagation of radio waves and does not indicate any malfunction of the system.

### Storing a radio station

Select a station.



Press the "Media" application.

In the list, select the "Player" tab.



Press the "Radio Favorites" button.



Storing takes place via a short or long press on one of these buttons, or a long press on an existing favourite radio station, which will be replaced.



Press this button to return to the previous page.

## Automatic search for radio stations

Via the "Media" application.



Press the "Media" application.

In the list, select the "Stations" tab.

The search is carried out automatically.



Using the steering-mounted controls, press and hold this button.

The search is carried out automatically.

## Activating radio station tracking

The system changes frequency automatically to obtain better reception.



Press the "Media" application.

In the list, select the "Settings" tab.



Activate "Radio Station Tracking".

The lighting of the slider confirms that the function is activated.

## Changing the waveband



Press the "**Media**" application.

In the list, select the "**Player**" tab.



Press this button to change the waveband (FM - AM - DAB) according to the country of sale.

## Activating traffic announcements

This function gives priority to listening to **Traffic announcements** alert messages. To be active, this function needs good reception of a radio station that transmits this type of message.

While traffic information is being broadcast, the current radio station is automatically interrupted so that the message can be heard. Normal radio listening resumes as soon as the message is finished.



Press the "**Media**" application.

In the list, select the "**Settings**" tab.



Activate "**Traffic Announcement (TA)**".

The lighting of the slider confirms that the function is activated.

## Audio streaming

The streaming function allows you to listen to the audio stream coming from the smartphone(s) connected via Bluetooth®, USB (iPod® type) or Mirror Screen®.

First adjust the volume on the portable device (to a high level).

Then adjust the volume of the system.

If playback does not start, it may be necessary to start the audio playback from the smartphone.

Control is from the portable device or by using the system's touch buttons.

**i** Once connected in streaming mode, the smartphone is considered to be a media source.

## Playing a track



Press the "**Media**" application.



If several devices are connected, press this button to select one.

Once the device is connected, browsing through the files is possible by pressing the "**Playlist**" or "**Library**" button.



Short press: go to the previous/next track.

Long press: fast-forward/rewind in a track.



Repeat the current title or the list of selected titles.



Random track playback.



Sound deactivation/reactivation.

## Configuring audio and radio settings

Audio settings can be accessed in 2 different ways.

Via the **Media** application



Press the "**Media**" application.

In the list, select the "**Settings**" tab.

Or

Via the **Settings** application



Press the "**Settings**" application.

In the list, select the "**Audio and Radio**" tab.

It is possible to configure:

- Sound Settings.
- Radio Settings.
- Volume Settings.

## Information and advice

The system supports USB Mass Storage devices or Apple® devices via the USB sockets. The adapter cable is not supplied.

Devices are managed using the audio system controls.

The system will only play audio files with ".wma", ".aac", ".flac", ".ogg", ".mp3" file extensions, at bit rates between 32 Kbps and 320 Kbps.

It also supports VBR (Variable Bit Rate) mode.

No other file types (".mp4", etc.) can be read.

".wma" files must be of the WMA 9 standard.

The supported sampling rates are 32, 44 and 48 KHz.

To avoid reading and display problems, we recommend choosing file names less than 20 characters long that do not contain any special characters (e.g. " ? . ; ù).

Use only USB memory sticks in FAT32 format (File Allocation Table).

**i** We recommend using the original USB cable for the portable device.

## Phone

### Receiving a call

An incoming call is announced by a ring and a display overlaid on the screen.

Accepting the call:

 briefly press the telephone button on the steering-mounted controls to accept an incoming call.

Or

 Press this touch screen button.

Ending the call:

 press and hold...

 ...the telephone button on the steering-mounted controls to refuse the call.

Or

 Press this touch screen button.



Press this button on the touch screen to send an automatic message indicating that you are driving.

### Making a call



Using the telephone is strongly discouraged while driving. Park the vehicle.

### Making a call using the numeric keypad



Press the "Phone" application.

In the list, select the "Keypad" tab then dial the number.



Press this button to make the call.

### Making a call using the list of recent calls



Press the "Phone" application.

In the list, select the "Calls" tab.

Or

Briefly press...



...the telephone button on the steering-mounted controls.

Select and call one of the most recent numbers called in the list.



It is always possible to make a call directly from the telephone; as a safety measure, first park the vehicle.

### Calling a contact



Press the "Phone" application.

In the list, select the "Contacts" tab.

Select the desired contact in the displayed list.



Call the contact by selecting one of the contact's phone numbers.

### Organising the contact list



Press the "Phone" application.

In the list, select the "Settings" tab to display the telephone-related settings.



Choose to list the contacts starting with their first or last name.

### Connecting two phones



The system allows two phones to be connected simultaneously:

– 2 via Bluetooth® connection.

or

– 1 via Bluetooth® connection and 1 via Mirror Screen® connection.

Display and content priority is given to the last phone used.

To change the priority of the phone:



Press the "**Phone**" application.



Press this button to change the priority of the phone.

## Settings

### Configuring the screen display



Press the "**Settings**" application.

In the list, select the "**Customization**" tab.

It is possible to configure:

- the screen colours associated with the interior ambient lighting. Refer to the "Ease of use and comfort" section.
- the sound ambience.
- the visual welcome and goodbye animations.
- the screen transition animations.

### Managing the system connectivity



Press the "**Settings**" application.

In the list, select the "**Connectivity**" tab.

It is possible to manage:

- The Bluetooth® connection.
- The Mirror Screen® smartphone connections (Apple®CarPlay®/Android Auto).
- The Wi-Fi connection.
- The privacy mode.

### Configuring the system



Press the "**Settings**" application.

In the list, select the "**System**" tab.

It is possible to configure:

- the language.
  - the date & time.
  - the unit of distance and consumption (kWh/100 miles - miles, mi/kWh - miles, km/kWh - km).
  - the temperature unit (Fahrenheit, Celsius).
- It is also possible to reset the system configuration.

#### Selecting the language



Select "**Language**" to change the language.



Press the desired language.



Press the back arrow to return to the previous page.

#### Setting the date and time

Select "**Date and Time**" to modify the date and time.



"**Automatic Date and Time**" is activated by default, so that the setting is made automatically according to your geolocation.

To adjust manually, deactivate "**Automatic Date and Time**".

Press the "**Select Time Zone**" field then define a time zone.



Press the back arrow to return to the previous page.

Press the "**Time Settings**" line then set the time.

Press "**OK**" to confirm.



Press the "**Date**" line then set the date.

Press "**OK**" to confirm.



Select the Time Format (12h/24h).



Select the Date Format.



**i** The system does not automatically change between winter and summer time (depending on the country of sale).

## Help



Press the "**Help**" application.

In the list, select the "**User Manual**" tab to consult the vehicle's handbook.

or

In the list, select the "**Tutorials**" tab to watch explanatory videos for a quick start on screen management, certain driving aids and voice recognition.

### User Manual



Select the display language.

The handbook home page is displayed.

It presents the different possibilities for accessing the information sought:



### Visual search

Access to subjects via pictures

representing the exterior and interior of the vehicle.



### Indicator lamps

Access to the descriptions/operation of the instrument panel warning/indicator lamps.



### System

Access to sections dedicated to the various audio equipment and telematics systems.



### Contents

Access to subjects via the main sections of the handbook.

## Visual search



Press **Visual search**.

Press one of the pictures located at the bottom of the screen.



Press one of the bullet points in the enlarged view.

There are two cases:

- Direct display of the subject, if only one subject is associated with the bullet point.
- Display of a list of subjects, if several subjects are associated with the bullet point.

## Indicator lamps



Press **Indicator lamps**.

The mosaic of warning/indicator lamps is displayed.

The warning/indicator lamps are sorted by colour.

Press the warning/indicator lamp concerned; the corresponding content is displayed.



Back to the mosaic of warning/indicator lamps.

## System



Press **System**.

The list of audio and telematics systems is displayed.

Press on the section concerned; the list of subjects is displayed.

Press on the subject concerned; the corresponding content is displayed.



If the subject has more than one page, drag horizontally.



Back to the list of subjects.

## Contents



Press **Contents**.

The list of sections is displayed.

Press on the section concerned; the list of subjects is displayed.

Press on the subject concerned; the corresponding content is displayed.



If the subject has more than one page, drag horizontally.



Back to the list of subjects.

## Vehicle data recording and privacy

Electronic control units are installed in your vehicle. These control units process data received from the vehicle's sensors, for example, or data they generate themselves or exchange with each other. Some of these control units are required for the correct operation of your vehicle, some others assist you while driving (driving or manoeuvring aids), while others provide comfort or infotainment functions.

The following contains general information about how data is processed within the vehicle.

You will find additional information about the specific data which is downloaded, stored and transmitted to third parties and what it is used for in your vehicle under the keyword "Data protection". This information is directly associated with the references for the functions in question contained in the corresponding vehicle handbook, or in the general terms and conditions of sale.

This information is also available online.

### Vehicle operating data

The control units process the data used for the operation of the vehicle.

This data includes, for example:

- Information about the state of the vehicle (e.g. speed, travel time, lateral acceleration, wheel rotation rate, fastened seat belts display).

- Environmental conditions (e.g. temperature, rain sensor, distance sensor).

As a general rule, this data is temporary, is not stored for longer than one operating cycle and is only used within the vehicle itself. The control units often record this data (including the vehicle's key). This function allows either the temporary or permanent storage of information about the state of the vehicle, stresses on components, servicing requirements, as well as events and technical errors.

Depending on the vehicle's equipment level, the data stored is as follows:

- Operating state of system components (e.g. filling level, tyre pressures, battery charge status).
- Faults and malfunctions in important system components (e.g. lamps, brakes).
- System reactions in specific driving situations (e.g. deployment of an airbag, triggering of stability control and braking systems).
- Information about events which have damaged the vehicle.
- For electric and rechargeable hybrid vehicles, the traction battery charge level and the estimated driving range.

In particular circumstances (e.g. if the vehicle has detected a malfunction), it may be necessary to record data which would otherwise simply not be stored.

When taking your vehicle in for servicing (e.g. repairs, maintenance), the stored operating data may be read along with the vehicle's

identification number and used if necessary.

The personnel working for the servicing network (e.g. garages, manufacturers) or third parties (e.g. roadside assistance agents) may read the vehicle's data. This also applies to work carried out under warranty and quality assurance measures.

This data is generally read via the OBD (On-Board Diagnostics) port fitted by law to the vehicle. It is used to report on the technical state of the vehicle or its components and facilitates the diagnosis of malfunctions, in compliance with warranty obligations and for quality improvement. This data, in particular the information relating to stress on components, technical events, operator errors and other malfunctions, is sent to the Manufacturer, if necessary, along with the vehicle's identification number. The Manufacturer's liability may also be engaged. The Manufacturer may also use the operating data taken from the vehicle for product recalls. This data may also be used to check the customer's warranty and any claims made under warranty.

Any malfunctions stored in the vehicle may be reset by an after-sales service company during servicing or repair work, or at your request.

## Comfort and infotainment functions

Comfort settings and personalised settings may be saved in the vehicle and modified or reinitialised at any time.

Depending on the vehicle's equipment level, this may include:

- Seat and steering wheel position settings.
- Chassis and air conditioning settings.
- Personalised settings such as the interior lighting.

You can enter your own data into the functions of your vehicle's audio and telematic system, as part of the selected functionalities.

Depending on the vehicle's equipment level, this may include:

- Multimedia data such as music, videos or photos to be read by an integrated multimedia system.
- Address book data to be used with an integrated hands-free system or with an integrated navigation system.
- Entered destinations.
- Data regarding the use of online services.

This data for the comfort and infotainment functions may be stored locally in the vehicle or saved to a device that you have connected to the vehicle (e.g. smartphone, USB memory stick or MP3 player). Data that you have entered yourself may be deleted at any time.

This data may also be transmitted outside the vehicle at your request, particularly when using

online services in line with the settings that you have selected.

## Smartphone integration (e.g. Android Auto® or Apple® CarPlay®)

If your vehicle is equipped accordingly, you can connect your smartphone or another mobile device to the vehicle in order to operate it using the vehicle's integrated controls. Images and sounds from the smartphone can be transmitted through the audio and telematics system.

Specific information is simultaneously sent to your smartphone. Depending on the type of integration, this includes data such as location, day/night mode and other general information about the vehicle. For more information, please refer to the user instructions for the vehicle or the audio and telematics system.

Integrating a smartphone allows you to use its applications, such as a navigation app or music player. No other integration between the smartphone and the vehicle is possible, in particular active access to vehicle data. How the data is processed subsequently is determined by the supplier of the application being used. The ability the change settings depends on the application in question and on the operating system installed on your smartphone.

## Online services

If your vehicle is connected to a wireless network, data can be exchanged between your vehicle and other systems. Connection to a wireless network is made possible via a transmitter located in your vehicle or a mobile device that you have provided (e.g. smartphone). The online services can be used via this wireless connection. These include online services and applications (apps) provided to you by the Manufacturer or other suppliers.

## Exclusive services

As regards the Manufacturer's online services, the corresponding functions are described by the Manufacturer in an appropriate medium (e.g. handbook, Manufacturer's website) and the information about data protection is provided. Personal data may be used for online services. The exchange of data for this purpose takes place over a secure connection, using for example the Manufacturer's dedicated computer systems. The collection, processing and use of personal data for the development of services are carried out solely on the basis of a legal authorisation, for example in the case of a legal emergency call system or a contractual agreement or else under a consent agreement. You can activate or deactivate the services and functions (some may be chargeable) and, in some cases, the vehicle's entire connection to the wireless network. This does not include the



statutory functions and services such as the emergency or assistance call system.

## Third-party services

If you use online services provided by other (third-party) suppliers, these services are subject to the responsibility, the data protection and the terms and conditions of use of the supplier in question. The Manufacturer often has no influence over the content exchanged in this regard.

Please therefore ensure that you are aware of the nature, extent and purpose of the collection and use of personal data as part of the third-party services provided by the service provider in question.

---

**A**

ABS ..... 84

Accelerated charging unit  
(Wallbox) ..... 168–169, 175

Accessories ..... 80

Accessories, electrical ..... 80

Active LED Vision ..... 71, 73

Active Safety Brake ..... 142–145

AdBlue® ..... 21, 193

AdBlue® tank ..... 195

Additive, Diesel ..... 192

Adjusting headlamps ..... 70

Adjusting head restraints ..... 47

Adjusting seat ..... 47–48

Adjusting the air distribution ..... 56–57

Adjusting the air flow ..... 56–57

Adjusting the headlamp beam height ..... 70

Adjusting the height and reach of  
the steering wheel ..... 51

Adjusting the lumbar support ..... 48

Adjusting the seat angle ..... 48

Adjusting the temperature ..... 56

Adjusting the time ..... 243

Advice on care and  
maintenance ..... 163–164, 196

Advice on driving ..... 9, 98–99

Airbags ..... 88, 90, 92

Airbags, curtain ..... 89–90

Airbags, front ..... 89–90, 92

Airbags, lateral ..... 89–90

Air conditioning ..... 55–56, 58

Air conditioning, automatic ..... 59

Air conditioning, dual-zone automatic ..... 56

Air intake ..... 58

Air vents ..... 55

Alarm ..... 41–42

Amplifier, audio ..... 63

Anti-lock braking system (ABS) ..... 84

Antitheft / Immobiliser ..... 32

Applications ..... 27, 29

Armrest, front ..... 63

Armrest, rear ..... 64

Assistance call ..... 81–82

Assistance, emergency braking ..... 84, 144

Audio streaming (Bluetooth) ..... 241

---

**B**

Battery, 12 V ..... 187, 192, 209–216

Battery, 48 V ..... 163, 214

Battery, ancillaries ..... 209–210

Battery, charging ..... 210–211, 213–215

Battery, remote control ..... 35–36

Blanking screen (snow shield) ..... 185

Blind ..... 44

BlueHDi ..... 21, 191, 199

Bluetooth (hands-free) ..... 237

Bluetooth (telephone) ..... 237–238

Bodywork ..... 197

Bonnet ..... 188–189

Boot ..... 37, 40, 68

Brake discs ..... 193

Brake lamps ..... 208–209

Brakes ..... 193

Braking ..... 110, 112

Braking assistance system ..... 84

Braking, automatic emergency ..... 142–145

Braking, dynamic emergency ..... 103–104

Bulbs (changing) ..... 207–209

---

**C**

Capacity, fuel tank ..... 160

Care of the bodywork ..... 197

Central locking ..... 33–34

Changing a bulb ..... 207–209

Changing a fuse ..... 209

Changing a wheel ..... 200, 204

Changing a wiper blade ..... 78

Changing the remote control battery ..... 35

Changing to free-wheeling ..... 195, 218

Charge level indicator (Rechargeable  
hybrid) ..... 24

Charger, induction ..... 62

Charger, wireless ..... 62

Charging cable ..... 165

Charging cable (Electric) ..... 175

Charging cable (Rechargeable  
hybrid) ..... 168–169, 172

Charging connector (Electric) ..... 174, 177,  
179–180

Charging connector (Rechargeable  
hybrid) ..... 168, 170, 172–173

- Charging flap (Electric) ..... 174, 177, 179–180  
 Charging flap (Rechargeable hybrid) ... 168, 170, 172–173  
 Charging system (Electric) ..... 7, 173, 189  
 Charging the battery ..... 214  
 Charging the traction battery  
 (Electric) ..... 173, 177, 179–180  
 Charging the traction battery (Rechargeable hybrid) ..... 22, 167, 170, 172–173  
 CHECK ..... 25  
 Checking the engine oil level ..... 20  
 Checking the levels ..... 190–191  
 Checking tyre pressures  
 (using the kit) ..... 201, 203  
 Checks ..... 189, 191–193  
 Checks, routine ..... 191–192  
 Child lock ..... 97  
 Children ..... 87, 93–94  
 Children (safety) ..... 97  
 Child seats ..... 87, 90–92, 94  
 Child seats, conventional ..... 94–96  
 Child seats, i-Size ..... 94–96  
 Child seats, ISOFIX ..... 93–96  
 Cleaning (advice) ..... 163–164, 196–198  
 Closing the boot ..... 33, 37  
 Closing the doors ..... 33, 37  
 Collision Risk Alert ..... 142–144  
 Configuration, vehicle ..... 12, 27  
 Connection, Bluetooth ..... 237–238  
 Connectivity ..... 243  
 Consumptions ..... 28  
 Container, AdBlue® ..... 194  
 Control, emergency boot release ..... 37  
 Control, emergency door ..... 35  
 Control, heated seats ..... 49–50  
 Controls, steering mounted ..... 106, 109  
 Control stalk, lighting ..... 69–70  
 Control stalk, wipers ..... 75–77  
 Control unit ..... 165, 168–169, 172, 175  
 Courtesy lamps ..... 64  
 Cruise control ..... 124, 126, 128–129  
 Cruise control, adaptive ..... 124, 126, 130–131  
 Cruise control by speed limit  
 recognition ..... 124, 126  
 Cup holder ..... 60
- 
- D**
- Date (setting) ..... 243  
 Daytime running lamps ..... 70  
 Deactivating the passenger airbag ..... 89, 92  
 Deadlocking ..... 31, 33  
 Deferred charging ..... 29, 172, 178  
 Deferred charging (Electric) ..... 174, 177  
 Deferred charging (Rechargeable hybrid) ..... 28–29, 168, 170  
 Defrosting ..... 51, 59  
 Defrosting, front ..... 59  
 Defrosting, rear screen ..... 59  
 Demisting ..... 51, 59  
 Demisting, front ..... 59  
 Demisting, rear ..... 59  
 Diagnosis, vehicle ..... 25
- Dials and gauges ..... 11  
 Digital instrument panel ..... 11  
 Dimensions ..... 227  
 Dipstick ..... 20, 190  
 Direction indicators (turn signals) ... 70, 208–209  
 Display screen, instrument panel ..... 12  
 Domestic charging ..... 165  
 Domestic charging (Electric) ..... 178–180  
 Domestic charging (Rechargeable hybrid) ..... 172–173  
 Door pockets ..... 60  
 Doors ..... 37  
 Drive Assist Plus ..... 130  
 Drive, electric .... 7, 173, 181, 189, 210, 218, 226  
 Driver's attention warning ..... 146–147  
 Drive selector (Electric) ..... 112  
 Driving ..... 46–47, 98–99, 121  
 Driving aids camera (warnings) ..... 120  
 Driving aid shortcuts ..... 121  
 Driving aids (recommendations) ..... 119  
 Driving economically ..... 9  
 Driving modes ..... 113  
 Driving modes (Electric) ..... 114  
 Driving positions (storing) ..... 49  
 Dynamic stability control (DSC) ..... 85
- 
- E**
- e-Auto mode ..... 56, 117, 160  
 EBFD ..... 84  
 Eco-driving (advice) ..... 9

ECO mode ..... 113–114  
 Electronic brake force distribution (EBFD) ..... 84  
 Emergency braking assistance (EBA) ..... 84  
 Emergency call ..... 81–82  
 Emergency switching off ..... 102  
 Emergency warning lamps ..... 80, 199  
 Emissions control system, SCR ..... 22, 193  
 Energy economy (mode) ..... 187  
 Energy economy mode ..... 187  
 Energy flows ..... 28  
 Energy recovery ..... 22, 110, 112  
 Engine ..... 193  
 Engine, 48 V hybrid ..... 117, 163, 218, 223  
 Engine compartment ..... 189  
 Engine, Diesel ..... 160, 189, 199, 222  
 Engine, petrol ..... 114, 189, 221  
 Engines ..... 220–223  
 Environment ..... 9, 36, 99  
 e-Save function (energy reserve) ..... 29  
 ESC (electronic stability control) ..... 84  
 Event data recorder ..... 83  
 Expanded traffic sign recognition ..... 126  
 Exterior lighting ..... 72

---

## F

Fatigue detection ..... 146–147  
 Favourite driving functions ..... 121  
 Filling the AdBlue® tank ..... 191, 195  
 Filling the fuel tank ..... 160–161  
 Filter, air ..... 192

Filter, oil ..... 192  
 Filter, particle ..... 192  
 Filter, passenger compartment ..... 55, 192  
 Fitting a wheel ..... 205–206  
 Fitting roof bars ..... 185  
 Fittings, boot ..... 66  
 Fittings, front ..... 60  
 Fittings, interior ..... 61  
 Fittings, rear ..... 64  
 Flap, charging ..... 172, 178  
 Flap, fuel filler ..... 160–161  
 Flap, ski ..... 64  
 Flashing indicators ..... 70  
 Flat bed (towing) ..... 218  
 Floor, boot, adjustable ..... 67  
 Fluid, brake ..... 191  
 Fluid, engine coolant ..... 191  
 Foglamps, rear ..... 69, 209  
 Folding the rear seats ..... 53–54  
 Frequency (radio) ..... 240  
 Fuel ..... 9, 160  
 Fuel consumption ..... 9, 22  
 Fuel level, low ..... 160  
 Fuel (tank) ..... 160–161  
 Fuses ..... 209

---

## G

Gauge, fuel ..... 160  
 Gearbox, automatic ..... 105–109, 111, 192, 210  
 Gearbox, dual-clutch automatic ..... 108

Gearbox, manual ..... 105, 192  
 Gear lever ..... 105, 115  
 Gear lever, manual gearbox ..... 105  
 Gear shift indicator ..... 115  
 Glove box ..... 61

---

## H

Hands-free access ..... 39  
 Hands-free tailgate ..... 39  
 Hazard warning lamps ..... 80, 199  
 Headlamps (adjustment) ..... 70  
 Headlamps, automatic dipping ..... 72–73  
 Headlamps, automatic operation ..... 71  
 Headlamps, main beam ..... 72  
 Head restraints, front ..... 47  
 Head restraints, rear ..... 53–54  
 Heated steering wheel ..... 51  
 Heating ..... 55  
 Heating, programmable ..... 29, 59  
 Hi-Fi system ..... 63  
 High voltage ..... 167, 173  
 Hill start assist ..... 114–115  
 Histogramme, fuel consumption ..... 28–29  
 Horn ..... 81  
 Hybrid, 48 V mild ..... 6, 117, 163, 218, 223  
 Hybrid system ..... 6, 163

---

**I**

Ignition ..... 101, 242

Ignition on ..... 101

Immobiliser, electronic ..... 100

Indicator, AdBlue® range ..... 21

Indicator, coolant temperature ..... 21

Indicator, engine oil level ..... 20

Indicators, direction ..... 70

Indicator, service ..... 19

Inflating tyres ..... 193, 228

Inflating tyres and accessories  
(using the kit) ..... 201, 203

Information, vehicle ..... 11, 245

Infrared camera ..... 120

Instrument panel ..... 11, 25, 25–26, 120

Instrument panels ..... 11

ISOFIX mountings ..... 93, 95–96

---

**J**

Jack ..... 200–201, 204

Jump starting ..... 210, 213

---

**K**

Key ..... 30, 32, 35

Key, electronic ..... 32–33

Keyless Entry and Starting ..... 30, 32–33,  
100–101

Key not recognised ..... 102

Key with remote control ..... 30, 100

Kit, hands-free ..... 237

Kit, puncture repair ..... 200–201

Kit, temporary puncture repair ..... 200–203

Klaxon ..... 81

---

**L**

Labels, identification ..... 228

Lamps, parking ..... 70

Lamps, rear ..... 208–209

Lamps with Full LED technology ..... 71, 73

Lane keeping assist ..... 148

Lane positioning assist ..... 130, 135–136

Leather (care) ..... 198

LEDs - Light-emitting diodes ..... 70, 208–209

Level, AdBlue® ..... 191

Level, brake fluid ..... 191

Level, Diesel additive ..... 192

Level, engine coolant ..... 21, 191

Level, engine oil ..... 20, 190

Levels and checks ..... 189–191

Level, screenwash fluid ..... 76, 191

Light-emitting diodes - LEDs ..... 70, 208–209

Lighting, boot ..... 68

Lighting dimmer ..... 25

Lighting, exterior ..... 69, 72

Lighting, guide-me home ..... 71

Lighting, interior ..... 64

Lighting, mood ..... 64

Lighting, welcome ..... 71–72

Loading ..... 185

Load reduction mode ..... 188

Locating your vehicle ..... 31

Locking ..... 31–33

Locking from the inside ..... 34

Locking the doors ..... 34

Log, alerts ..... 25

Long-distance blind spot monitoring ..... 150

Long objects, transporting ..... 64

Lumbar ..... 48

---

**M**

Mains socket (domestic network) .. 168–169, 175

Maintenance (advice) ..... 163–164, 196

Maintenance, routine ..... 120, 191, 193

Manoeuvring aids (recommendations) ..... 119

Map reading lamps ..... 64

Markings, identification ..... 228

Massage function ..... 50

Massage, multi-point ..... 50

Mat ..... 63, 120

Menu, shortcuts ..... 27

Minimum traction battery charge level  
(Electric) ..... 24

Mirror, rear view ..... 52

Mirrors, door ..... 51–52, 59, 150

Mirror, vanity ..... 61

Misfuel prevention ..... 161

Mobile application ... 29, 59, 170, 172, 177, 178

Motor, electric ..... 101, 114, 163, 167,  
189, 224, 226  
Motorised tailgate ..... 37–38, 40  
Mountings, ISOFIX ..... 93, 95–96

---

## N

Net, high load retaining ..... 67  
Net, luggage retaining ..... 66  
Normal mode ..... 113–114

---

## O

Obstacle detection ..... 151  
Oil change ..... 190  
Oil consumption ..... 190  
Oil, engine ..... 190  
On-board tools ..... 68, 199–201  
Opening the bonnet ..... 188–189  
Opening the boot ..... 32, 37  
Opening the doors ..... 32, 37

---

## P

Pads, brake ..... 193  
Paint ..... 197, 228  
Paint colour code ..... 228  
Parking brake, electric ..... 102–104, 193  
Parking (sensors) ..... 151

Parking sensors, audible and visual ..... 151  
Parking sensors, front ..... 152  
Parking sensors, rear ..... 151  
Passenger compartment temperature pre-  
conditioning (Rechargeable hybrid) ..... 29, 59  
Pedestrian horn (Electric) ..... 99  
Personalisation ..... 12, 29  
Plates, identification ..... 228  
Port, USB ..... 61, 64  
Post Collision Safety Brake ..... 84  
Power ..... 22  
Power indicator (Rechargeable hybrid) ..... 22  
Pressures, tyres ..... 193, 202, 228  
Pre-tensioning (seat belts) ..... 87  
Priming the fuel system ..... 199  
Profiles ..... 230  
Protecting children ..... 89–94  
Proximity Keyless Entry and Start ..... 32  
Public fast charging station ..... 175, 178  
Puncture ..... 201–202, 204

---

## R

Radar (warnings) ..... 119  
Radio ..... 240  
Range ..... 10  
Range, AdBlue® ..... 21, 191  
Reading lamps ..... 64  
Rear bench seat ..... 53  
Rear cross traffic alert ..... 157  
Rear screen (demisting) ..... 59

Rechargeable hybrid engine ..... 28, 218, 224  
Rechargeable hybrid system ..... 6, 28, 100,  
114, 167  
Recharging the battery ..... 210–211, 213, 215  
Recharging the traction battery ..... 165  
Recharging the traction battery  
(Electric) ..... 173, 177, 179–180  
Recharging the traction battery  
(Rechargeable hybrid) ..... 167, 170, 172–173  
Recirculation, air ..... 58  
Recorder, trip distance ..... 25  
Reduction of electrical load (mode) ..... 188  
Regeneration of the particle filter ..... 192  
Regenerative braking (deceleration  
by engine braking) ..... 110, 112  
Reinitialising the remote control ..... 36  
Reinitialising the under-inflation detection  
system ..... 119  
Reminder, lighting on ..... 69  
Remote control ..... 30–33, 35  
Remote functions ..... 172, 178  
Remotely operable functions (Rechargeable  
hybrid) ..... 29, 59  
Removing a wheel ..... 205–206  
Removing the mat ..... 63  
Replacing bulbs ..... 207–209  
Replacing fuses ..... 209  
Replacing the air filter ..... 192  
Replacing the oil filter ..... 192  
Replacing the passenger compartment  
filter ..... 192  
Reservoir, screenwash ..... 191

Resetting the trip ..... 25–26  
 Reversing camera ..... 120, 153–155  
 Reversing lamps ..... 208–209  
 Road sign recognition ..... 122  
 Roof bars ..... 185  
 Roof, opening ..... 44  
 Running out of fuel (Diesel) ..... 199

**S**

Safety, children ..... 89–94  
 Saturation of the particle filter (Diesel) ..... 192  
 Screens, very cold conditions ..... 185  
 Screenwash ..... 76  
 Screenwash, front ..... 76  
 Screenwash, rear ..... 76  
 SCR (Selective Catalytic Reduction) ..... 22, 193  
 Seat angle ..... 48  
 Seat belts ..... 86–87  
 Seat belts, rear ..... 86  
 Seats, electric ..... 48–49  
 Seats, front ..... 47–49  
 Seats, heated ..... 49–50  
 Seats, rear ..... 53–54, 91  
 Selector, gear ..... 105–108, 111, 115  
 Semi-automatic lane changing ..... 138  
 Sensors (warnings) ..... 120  
 Serial number, vehicle ..... 228  
 Servicing ..... 19, 191, 193  
 Settings, equipment ..... 12, 27  
 Shield, snow ..... 185  
 Sidelamps ..... 70, 208–209

Silent vehicle warning sound (Electric) ..... 99  
 Smartphone ..... 29, 62  
 Snow chains ..... 118, 187  
 Snow screen ..... 185  
 Socket, 12 V ..... 61  
 Socket, 12 V accessory ..... 61, 68  
 Socket, diagnostic ..... 80  
 Speakers ..... 63  
 Speed limiter ..... 124, 126–127  
 Speed limit recognition ..... 122  
 Speedometer ..... 11, 120  
 Sport mode ..... 113–114  
 Spotlamps, side ..... 72  
 Stability control (ESC) ..... 84–85  
 Starting a Diesel engine ..... 160  
 Starting/Stopping the vehicle ..... 100  
 Starting the engine ..... 100–101  
 Starting the vehicle ..... 100, 106  
 Starting using another battery ..... 102, 210, 213  
 State of charge, battery ..... 28  
 Station, radio ..... 240  
 Stay, engine bonnet ..... 188  
 Steering wheel ..... 121  
 Steering wheel (adjustment) ..... 51  
 Stickers, customising ..... 197  
 Stopping the vehicle ..... 101, 106, 111  
 Stop & Start ..... 26, 56, 59, 115–117, 160, 192, 212  
 Storage ..... 60–61, 63–65  
 Storage box ..... 68  
 Storage wells ..... 66, 68  
 Storing driving positions ..... 49  
 Stowing rings ..... 66–67

Sunshine sensor ..... 55  
 Sun visor ..... 61  
 Super-fast charging (Electric) ..... 179–180  
 Suspension ..... 193  
 Switching off the engine ..... 100–101  
 Synchronising the remote control ..... 36  
 System, event data recording ..... 83

**T**

Tables of engines ..... 221–224, 226  
 Tailgate ..... 37  
 Tank, fuel ..... 160–161  
 Technical data ..... 221–224, 226  
 Telephone ..... 237–238, 242  
 Temperature, coolant ..... 21  
 Thermal comfort consumption indicator (Electric) ..... 24  
 Thermal comfort equipment ..... 24  
 Time (setting) ..... 243  
 Tool box ..... 68  
 Tools ..... 199–201  
 Topping-up AdBlue® ..... 195  
 Top Tether (fixing) ..... 93, 95–96  
 Total distance recorder ..... 25  
 Touch screen ..... 26, 28–29, 59  
 Towball, quickly detachable ..... 181–184  
 Towbar ..... 85, 180  
 Towbar with quickly detachable towball ..... 181–184  
 Towed loads ..... 220–224, 226  
 Towing ..... 217, 219

Towing another vehicle ..... 219  
 Towing the vehicle ..... 217–219  
 Traction battery ..... 163  
 Traction battery charge ..... 165  
 Traction battery (Electric) ..... 173, 177  
 Traction battery (Rechargeable hybrid) ..... 24, 167, 170  
 Traction control (ASR) ..... 85  
 Trailer ..... 85, 180  
 Trailer stability assist (TSA) ..... 85  
 Trajectory control systems ..... 84  
 Triangle, warning ..... 199  
 Trip computer ..... 25–26  
 Tyres ..... 193, 228  
 Tyre under-inflation detection ..... 118, 202

---

## U

Under-inflation (detection) ..... 118  
 Unlocking ..... 30, 32  
 Unlocking from the inside ..... 34  
 Unlocking the boot ..... 30, 33  
 Unlocking the doors ..... 34  
 Unlocking the tailgate ..... 30, 33  
 Updating the time ..... 243

---

## V

Vehicle data recording and privacy ..... 245  
 Ventilation ..... 55  
 Visibility ..... 59

Visiopark ..... 155  
 Visiopark 1 ..... 153

---

## W

Wallbox (Electric) ..... 175  
 Wallbox (Rechargeable hybrid) ..... 168–169, 172  
 Warning and indicator lamps ..... 12–13  
 Warning lamp, driver's seat belt not fastened ..... 87  
 Warning lamps ..... 13  
 Warning lamp, seat belts ..... 87  
 Warnings and indicators ..... 12–13  
 Washing ..... 120  
 Washing (advice) ..... 163–164, 196–197  
 Weights ..... 220, 223, 226  
 Welcome lighting ..... 72  
 Wheel, spare ..... 193, 200–201, 204  
 Window controls ..... 43  
 Windscreen, heated ..... 59  
 Wiper blades (changing) ..... 78  
 Wiper, rear ..... 76  
 Wipers ..... 75  
 Wipers, automatic rain sensitive ..... 77  
 Wipers, windscreen ..... 75, 77



















































#### Recycled materials/End-of-Life Vehicles

Automobiles PEUGEOT declares, in accordance with the provisions of European legislation (Directive 2000/53) and The End-of-Life Vehicles (Producer Responsibility) (Amendment) Regulation 2010 No.1094, that it achieves the objectives set by these legislations and that recycled materials are used in the manufacture of the products that it sells.

Reproducing and translating this document, even partially, is strictly prohibited without written authorisation from Automobiles PEUGEOT.



**4D CONCEPT**

AUTOMOBILES PEUGEOT - Siège Social : 2-10, boulevard de l'Europe - 78300 POISSY  
<http://www.peugeot.com>  
Société anonyme au capital de 172.711.770 € - R.C.S. VERSAILLES : 552 144 503

Printed in the EU  
05-23



PEUGEOT



ANG. 23.P5.0040

